

**TM 9-1425-550-34**

---

**TECHNICAL MANUAL**

**DS AND GS MAINTENANCE MANUAL  
INTERCONNECTION DIAGRAMS  
FOR LCSS AND WEAPON SYSTEM  
UNITS TAPE TESTED BY AN/TSM-93  
(LAND COMBAT SUPPORT SYSTEM)**

This copy is a reprint which includes current  
pages from Changes 1 THROUGH 11.

---

**HEADQUARTERS, DEPARTMENT OF THE ARMY  
AUGUST 1973**

**WARNING****RADIATION**

Direct visual exposure to high energy infrared beams may result in permanent injury to eyesight. Ultraviolet (UV) radiation may cause severe burns. The possibility of shattering radiation source envelopes, resulting in high velocity propelled envelope material, requires visual and facial protection when working with optical transmitter assemblies and the test source.

**WARNING****DANGEROUS VOLTAGE**

is used in the operation of this equipment

**DEATH ON CONTACT**

may result if personnel fail to observe safety precautions

Never work on electronic equipment unless there is another person nearby who is familiar with the operation and hazards of the equipment and who is competent in administering first aid. When the technician is aided by operators, he must warn them about dangerous areas.

Whenever possible, the power supply to the equipment must be shut off before beginning work on the equipment. Take particular care to ground every capacitor likely to hold a dangerous potential. When working inside the equipment, after the power has been turned off, always ground every part before touching it.

Units tested in accordance with this manual contain a maximum of 85 vdc and 60 amps. Do not insert hands or metallic items into a unit during tape-controlled test unless specifically directed to do so.

Whenever the nature of the operation permits, keep one hand away from the equipment to reduce the hazard of current flowing through vital organs of the body.

**WARNING**

Do not be misled by the term "low voltage". Potentials as low as 50 volts may cause death under adverse conditions. For artificial respiration, refer to FM21-11.

**WARNING****SAFE MEASURES FOR HANDLING HIGH-PRESSURE**

Personnel who handle the nitrogen purging high-pressure air hoses and compounds shall be thoroughly trained in the use and maintenance of the equipment, and in the application of safety measures to protect against existing hazards.

Inspect the nitrogen purging system before, during, and after use for leaks, defective air hoses, improperly adjusted valves, malfunctioning regulators and relief valves, and the presence of foreign materials in the system.

Clear all air hoses and valves at regular intervals. Release pressure through bleeder valve before disconnecting any lines or hoses or making any repairs.

When pressurizing a UUT, personnel operating the nitrogen purging valves shall stand clear of hose connections, and shall turn the valves slowly to prevent shock loading or pressure surges which may damage hoses or components. Close valves manually to prevent overtightening; never tighten with a wrench or tool.

Observe the following precautions pertaining to high-pressure air hoses:

- a. The minimum bending radius for flexible air hoses shall be 4 inches for 1/4 inch ID hose; 6 inches for 3/8 inch ID hose; 7 inches for 1/2 inch ID hose; 9 1/4 inches for 3/4 inch ID hose.
- b. Never coat or paint an air hose, because this impairs the normal breathing tendency of the air hose.
- c. Depressurize and protect air hoses from the sun when not in use.
- d. Do not kink, twist, strike, walk on, run over, jerk, or otherwise abuse air hoses. Eye protection must be worn during operations where there is a possibility of pressurized nitrogen striking the face.

HEADQUARTERS, DEPARTMENT OF THE ARMY, Washington, D.C., 31 August 73

Direct Support and General Support Maintenance Manual: INTERCONNECTION DIAGRAMS FOR LCSS AND WEAPON SYSTEM TESTED BY TEST STATION AN/TSM - 93 (LAND COMBAT SUPPORT SYSTEM)

Table with columns for Paragraph, Page, Figure, and Page. Includes sections for Introduction, LCSS Interconnection Diagrams, LANCE Supplemental Equipment, and Dragon Interconnecting Diagrams.

## CHAPTER 1

### INTRODUCTION

#### 1-1. Scope

This manual contains interconnection diagrams depicting the interconnections between the AN/TSM-93 (Land Combat Support System—LCSS) and units under test (UUT) which are tape tested by the AN/TSM-93. The interconnection diagrams include the associated patchboard and any supplementary equipment used in testing the UUT.

#### 1-2. Manual Organization

This manual consists of separate chapters which contain interconnection diagrams for UUT's in the LCSS, SHILLELAGH, TOW, LANCE, and DRAGON weapons systems. For each LCSS and SHILLELAGH UUT, two interconnection diagrams are included—one for the hardware patchboard (squib type) and one for the printed circuit patchboard (multilayer type). The interconnection diagram for each UUT is identified by the basic UUT number and its nomenclature (e.g., UUT 2100, Missile Guidance Set). The interconnection diagrams are arranged in ascending numerical sequence within each chapter.

#### 1-3. Generation Guidelines

The following guidelines are reflected in each interconnection diagram.

- a. *UUT Interface Connections.* Connections to those connector pins of the UUT utilized during test are depicted, and each connection is identified by a functional name. Internal UUT circuitry generally is not shown.
- b. *Patchboard.* All interface connections between the patchboard, AN/TSM-93 and UUT are shown. All passive components and associated internal circuitry are depicted. Interface connections to active subassemblies within the patchboard are shown. However, internal circuitry on these subassemblies generally is not shown—each connection is identified by a functional name.
- c. *Load Boxes and Test Fixtures.* Interface connections to load boxes and test fixtures depict those connections utilized during UUT test. Internal detail is limited to only the circuitry utilized during UUT test.
- d. *Signal Conditioners.* Interface connections utilized during UUT testing are depicted, and each connection is identified by a functional name. Internal circuitry is not shown.
- e. *Cable Hook-Up.* All Go-Chain and Survey hook-up configurations are depicted. Changes in cable hook-ups required during No-Go testing are not shown.

#### 1-4. Notes

The following notes are applicable to all interconnection diagrams.

- a. *Resistors.* All resistance values are in ohms unless otherwise specified.
- b. *Capacitors.* All capacitance values are in microfarads (UFD) unless otherwise specified.
- c. *Tie Point.* This term appears only on multilayer patchboard schematics. For example, the patchpin sequence on a multilayer patchboard schematic may appear as follows:

7K	DA3 OUT
7U	TPA 90
11KK	(TIE POINT)
20QQ	J5 - F

Four patchpins are used to establish continuity in the above sequence. However, only three of the patchpins actually tie to a system interface point. The fourth pin, 11KK, is required because of the complexity of the printed circuit layout. The multilayer board in this case does not allow the interconnections for pins 7K, 7U, and 20QQ to be made without an additional feedthrough to tie together two layers of etch. The patchboard pin used for a feedthrough connection must not, however, tie in an unwanted system interface point into the connection sequence. Shield ground patchpin locations provide no electrical continuity to the patchpins used on multilayer boards. These locations are available for use as feedthrough tie points. 11KK is such a tie point.

#### 1-5. Report of Equipment Publications Improvements

Report of errors, omissions, and recommendations for improving this publication by the individual user is encouraged. Reports should be submitted on DA Form 2028 (Recommended Changes to Publications) and forwarded direct to Commander, US Army Missile Command, Redstone Arsenal, AL 35809, ATTN: AMSMI-NPM.

Section I. UTILIZING MULTILAYER TYPE PATCHBOARDS

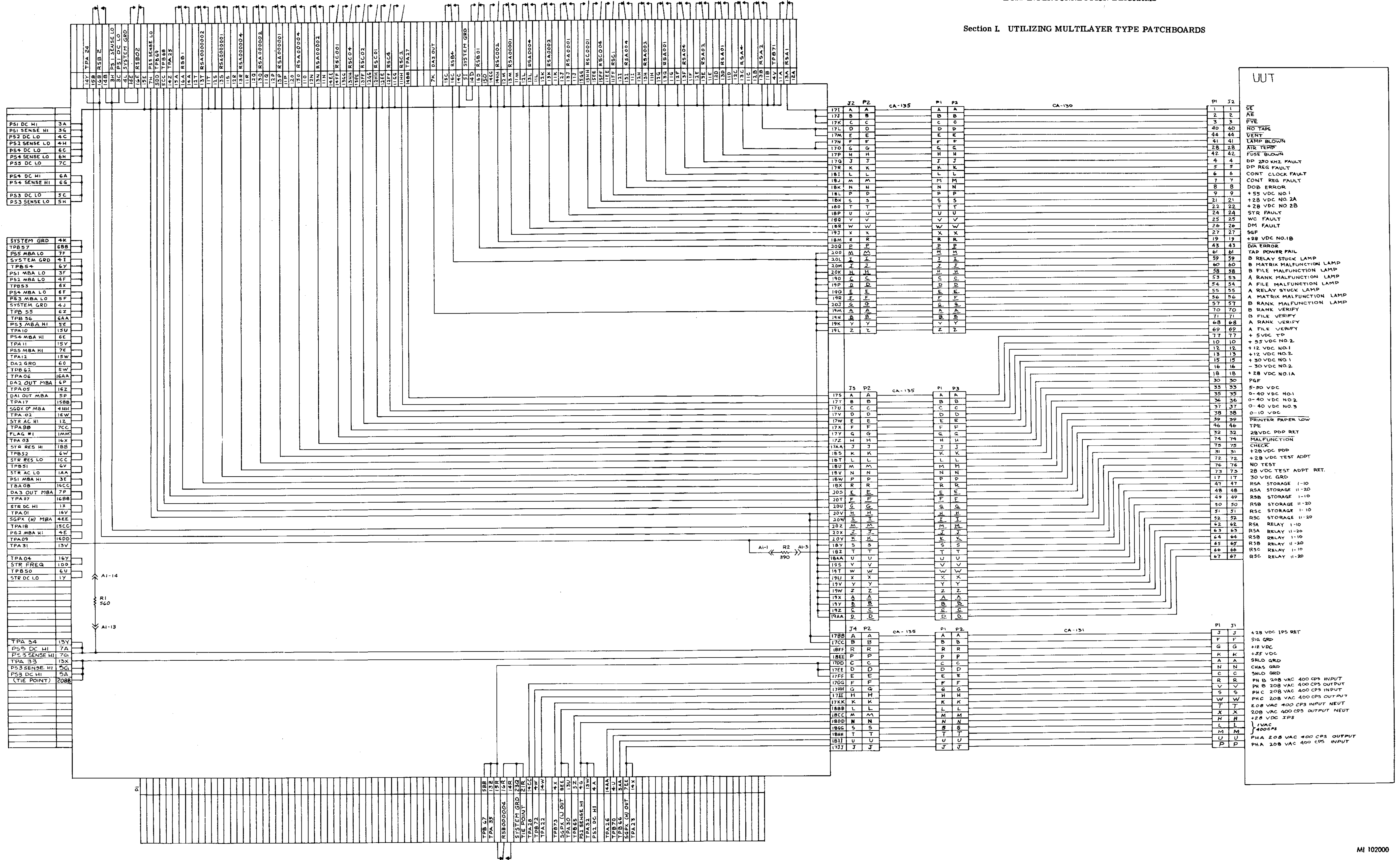

Figure 2-1. UUT 9030, Indicator Panel Interconnection Diagram.

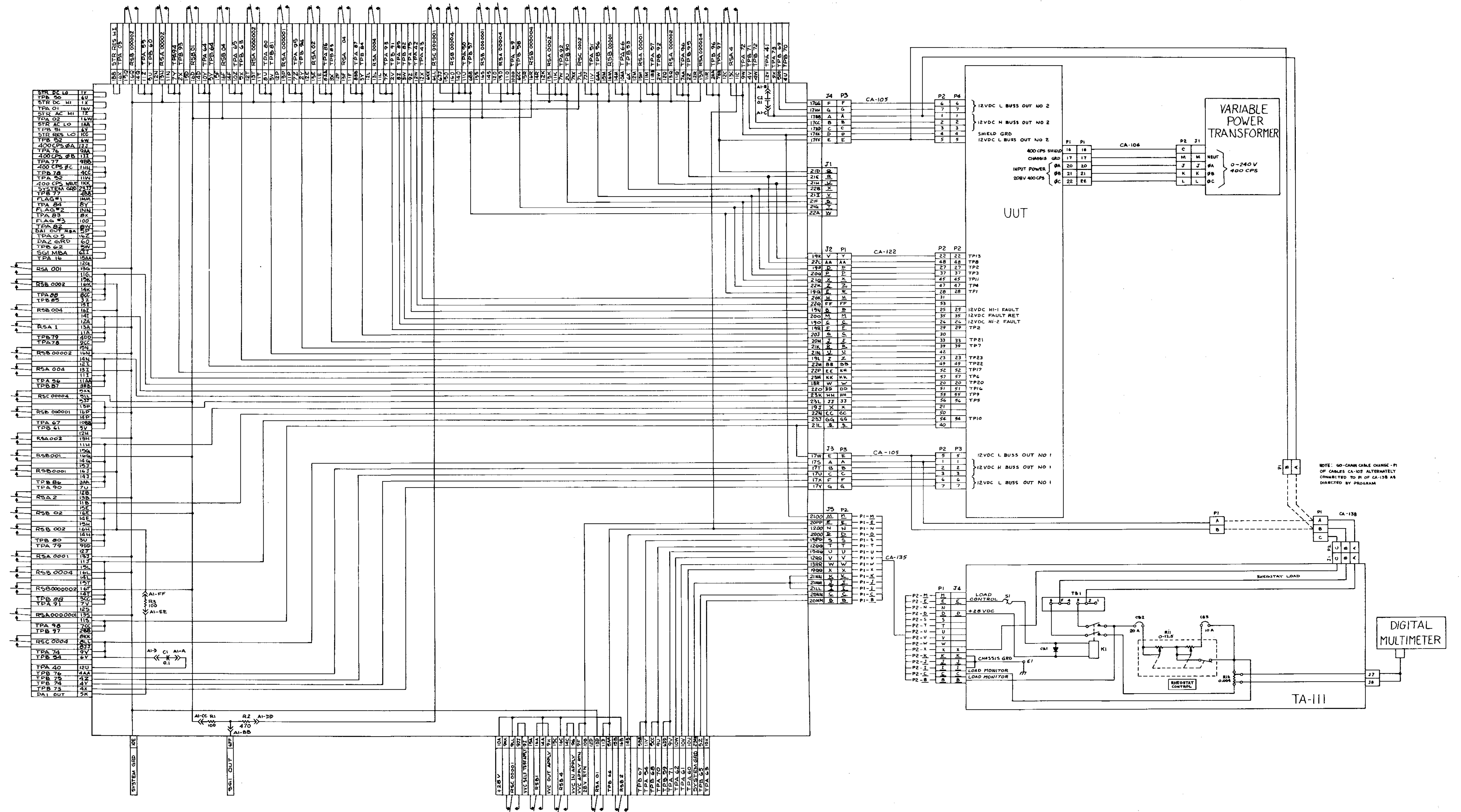

Figure 2-2. UUT 9050, 12 VDC Dual Power Supply Interconnection Diagram.

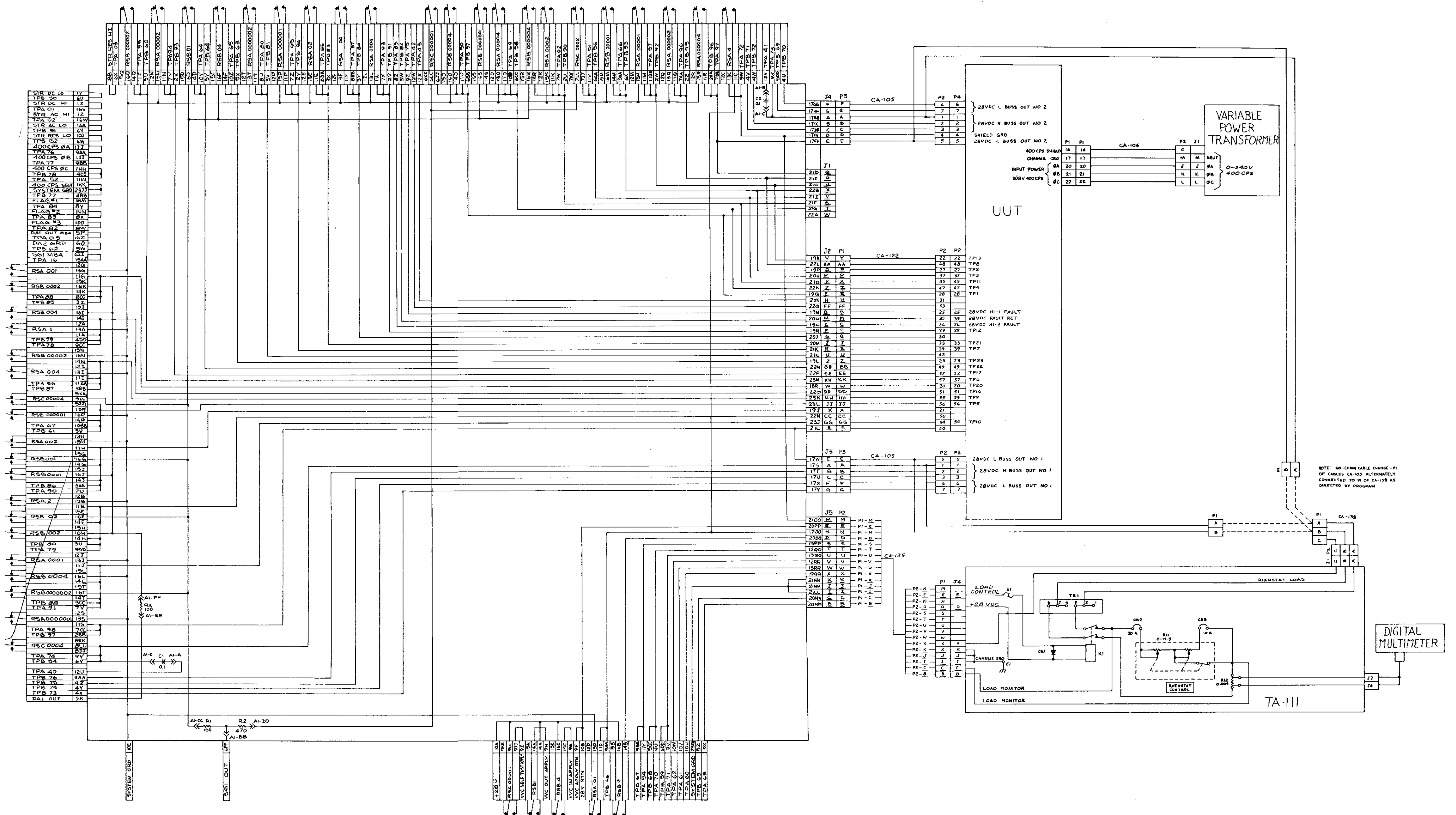

Figure 2-3. UUT 9060, 28 VDC Dual Power Supply Interconnection Diagram.

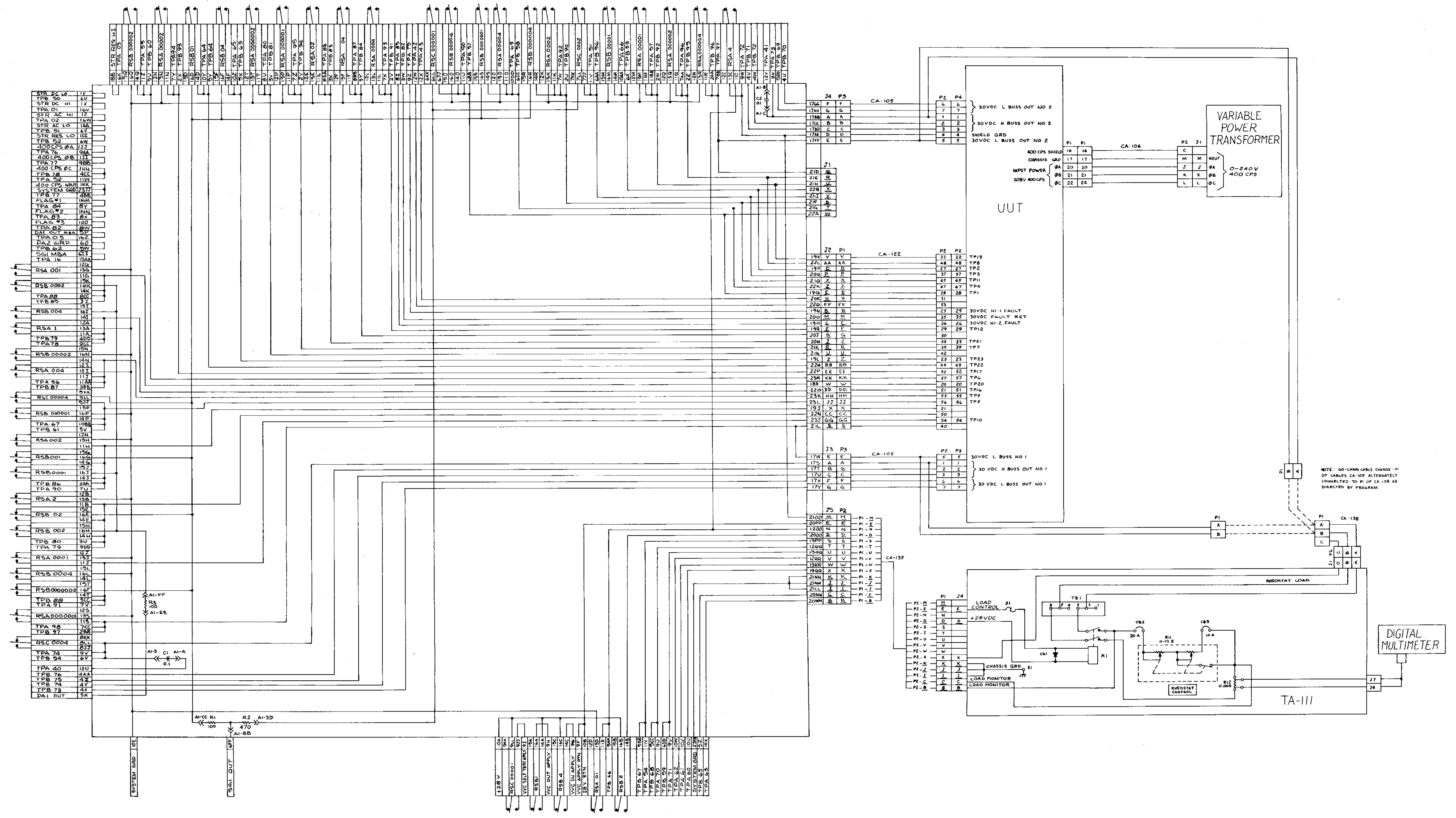

Figure 2-4. UUT 9070, 30 VDC Dual Power Supply Interconnection Diagram.



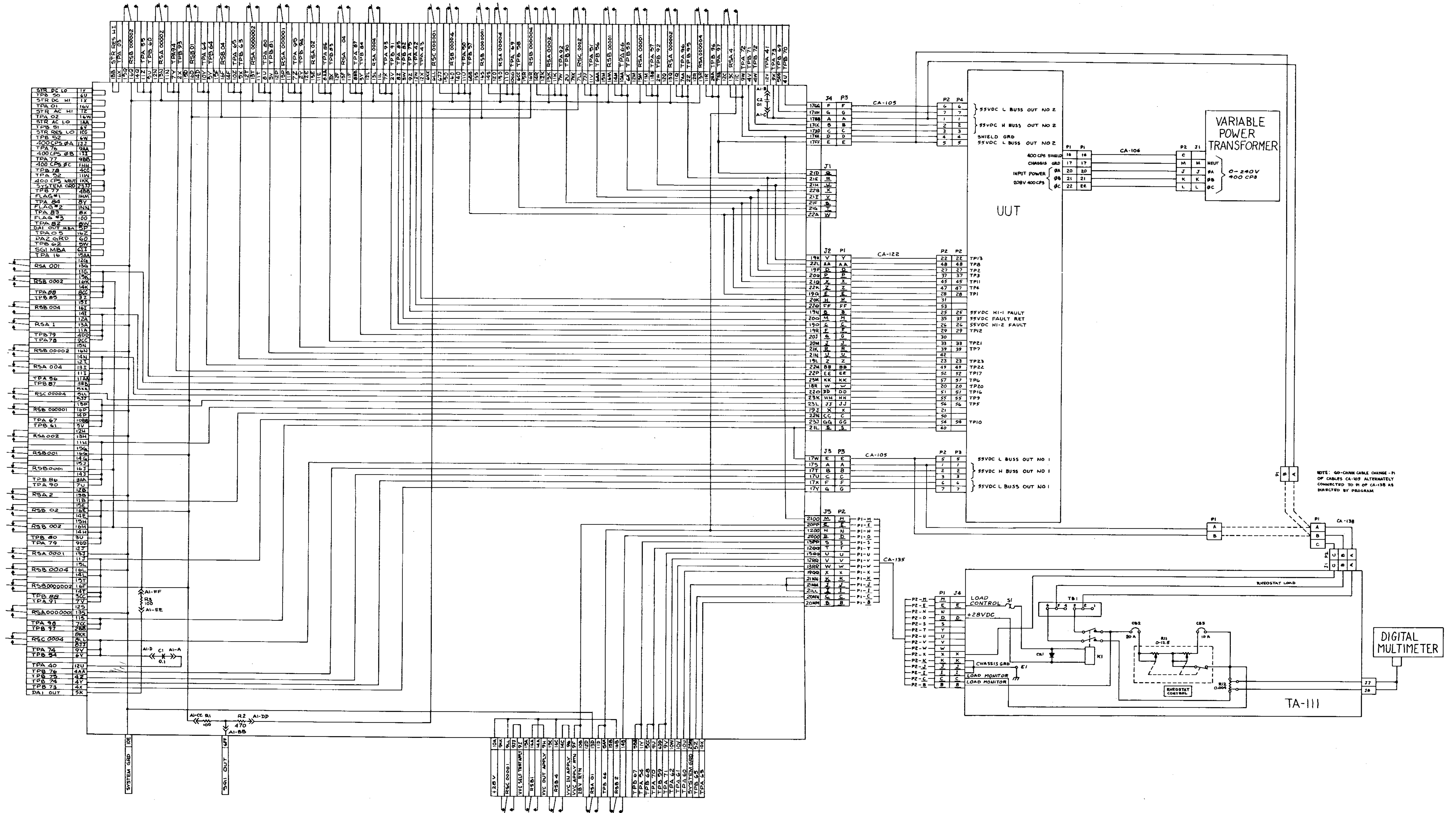

Figure 2-5. UUT 9080, 55 VDC Dual Power Supply Interconnection Diagram.

PATCHBOARD 106

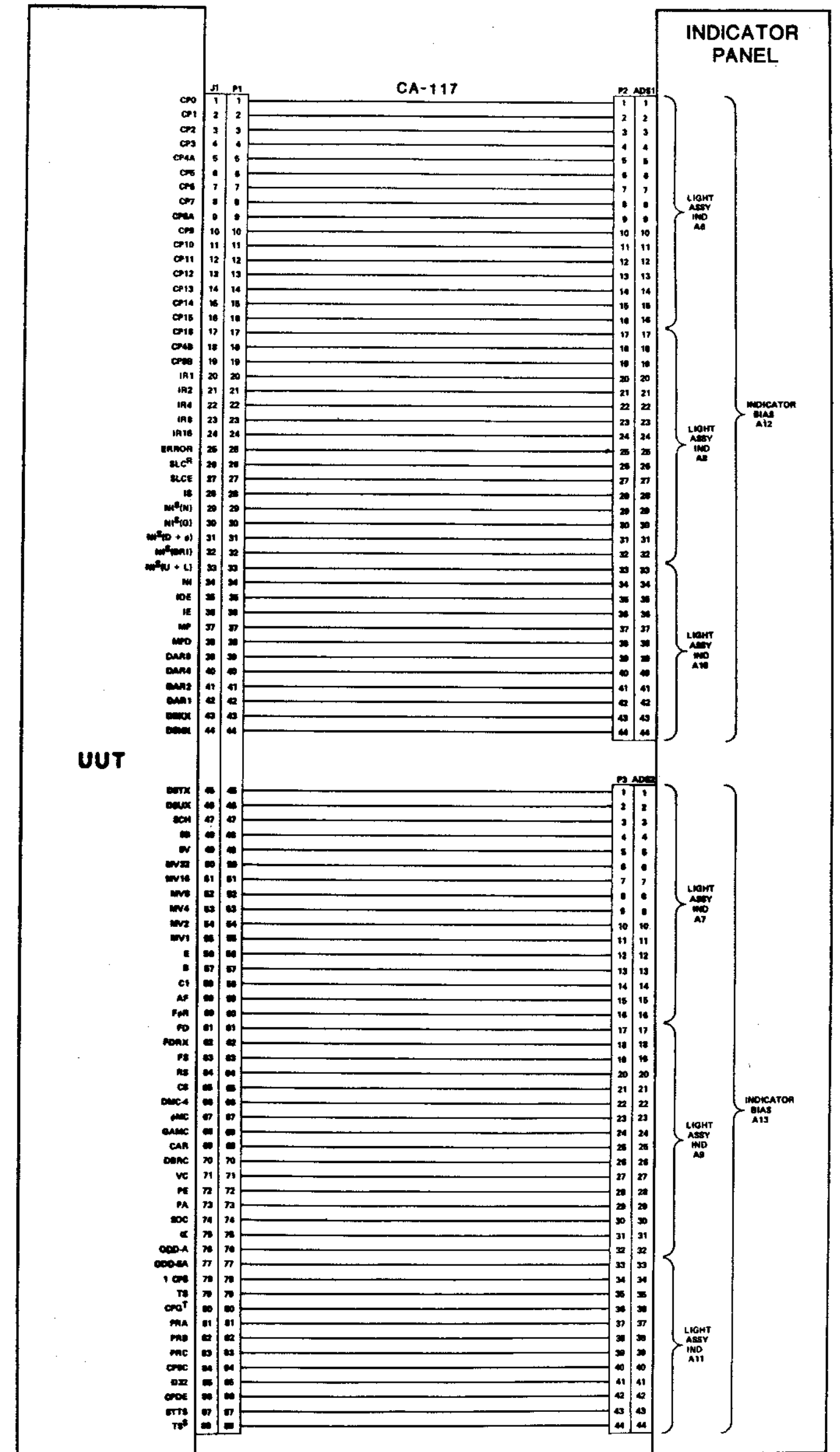
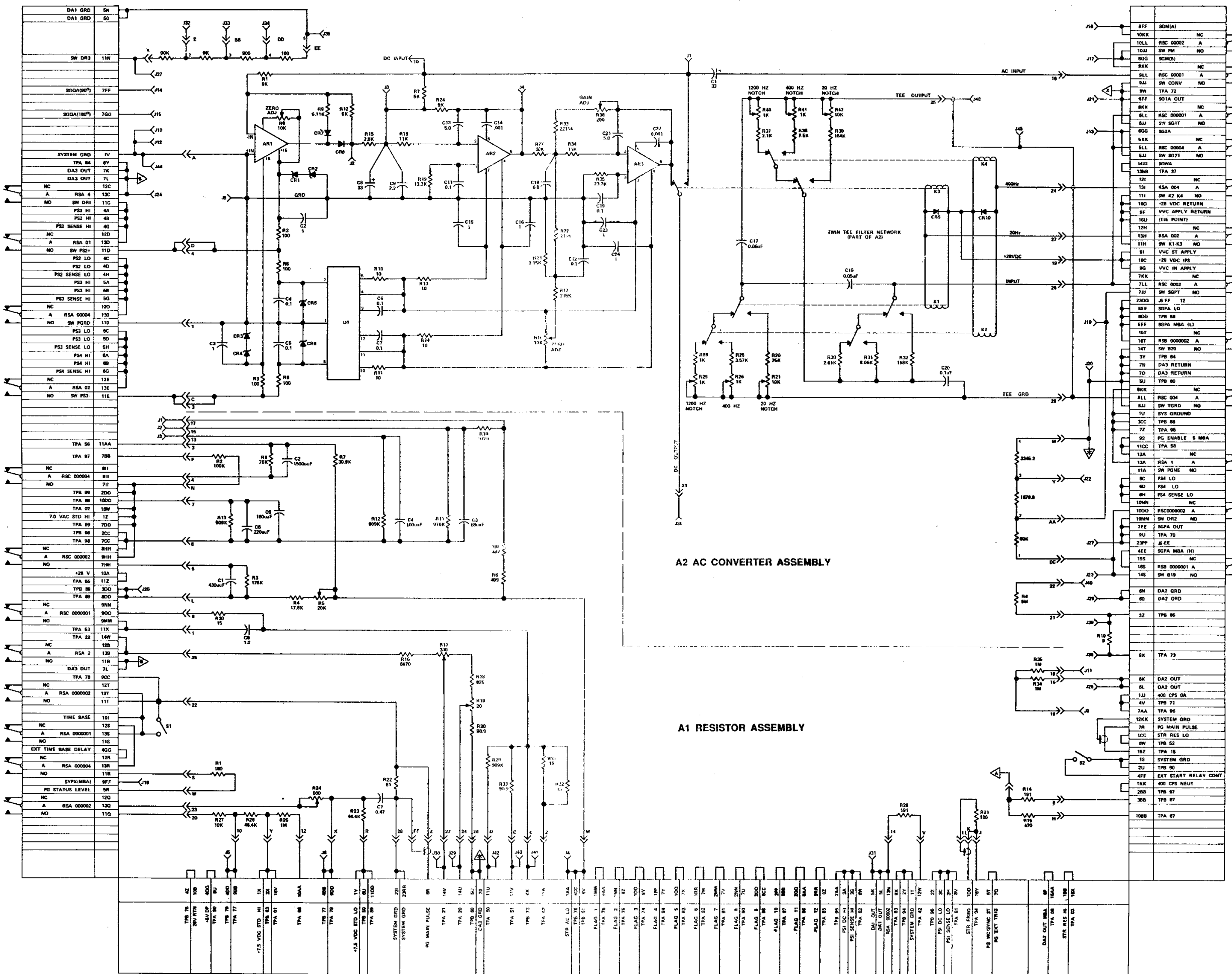

Figure 2-6. UUT 9110, Controller/Data Processor Interconnection Diagram.

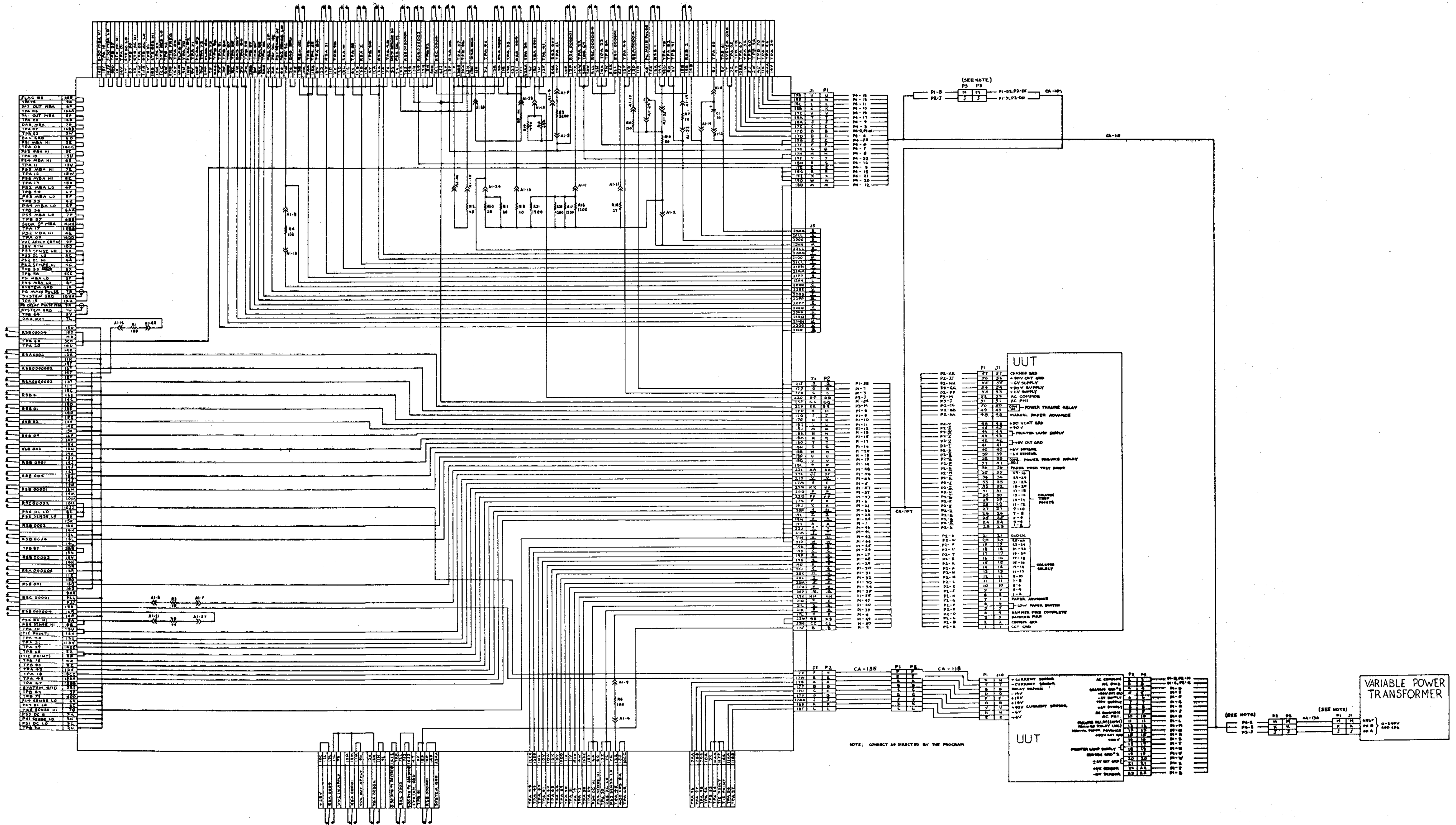
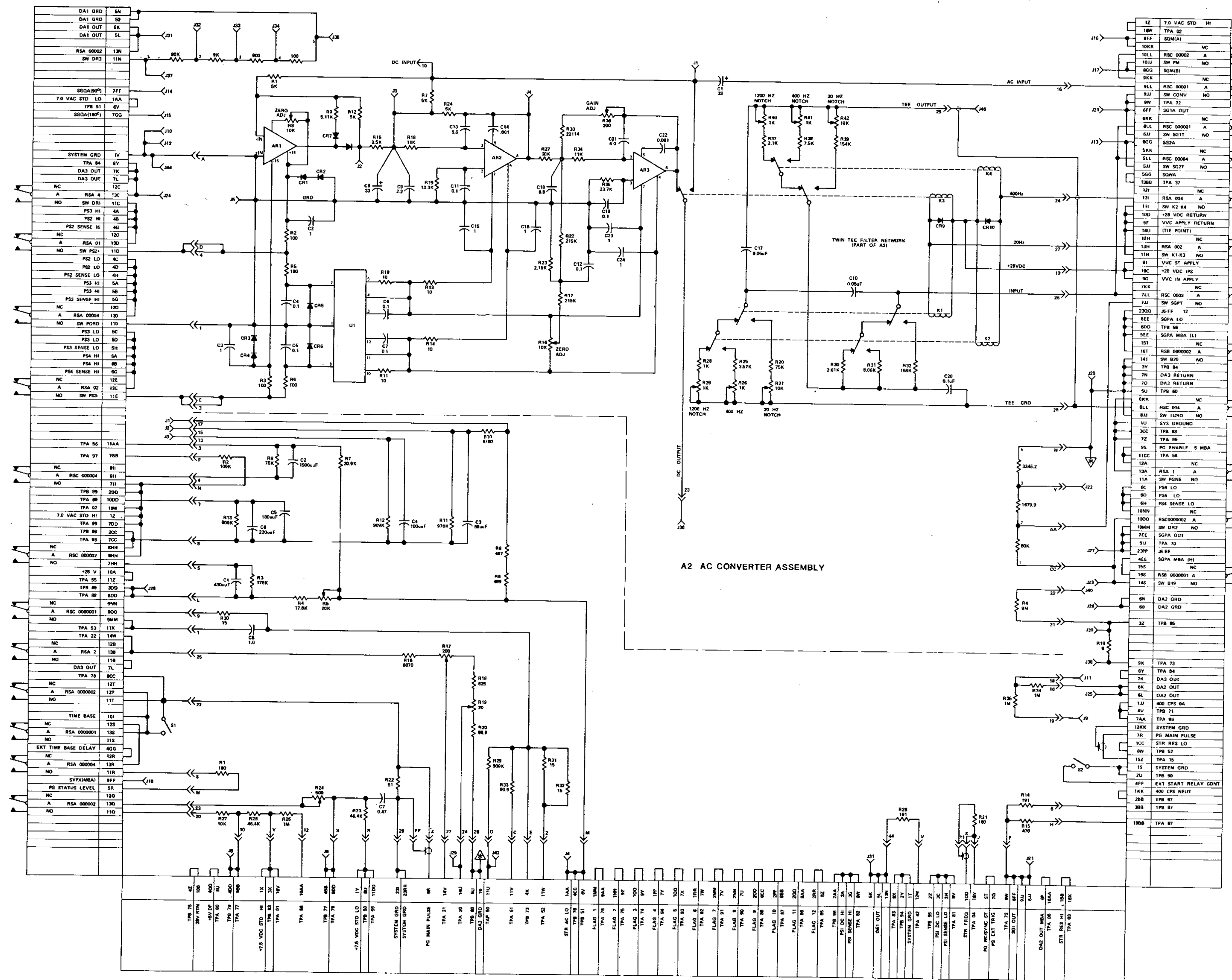

Figure 2-8. UUT 0220, Solid State Visual Display (SSVD) Interconnection Diagram.

PATCHBOARD 106



UUT

THIS UNIT IS NOT REMOVED FOR TESTING - IT IS CHECKED IN ITS POSITION IN THE CONSOLE. THERE ARE NO EXTERNAL CABLE CONNECTIONS BETWEEN THE UUT AND THE PATCHBOARD. CONNECTIONS BETWEEN THE UUT AND THE TEST ADAPTER ARE ACCOMPLISHED THRU THE CONSOLE OR WITH PROBES AS DIRECTED BY PROGRAM.

Figure 2-9. UUT 9230, digital multimeter interconnection diagram.

PATCHBOARD 106

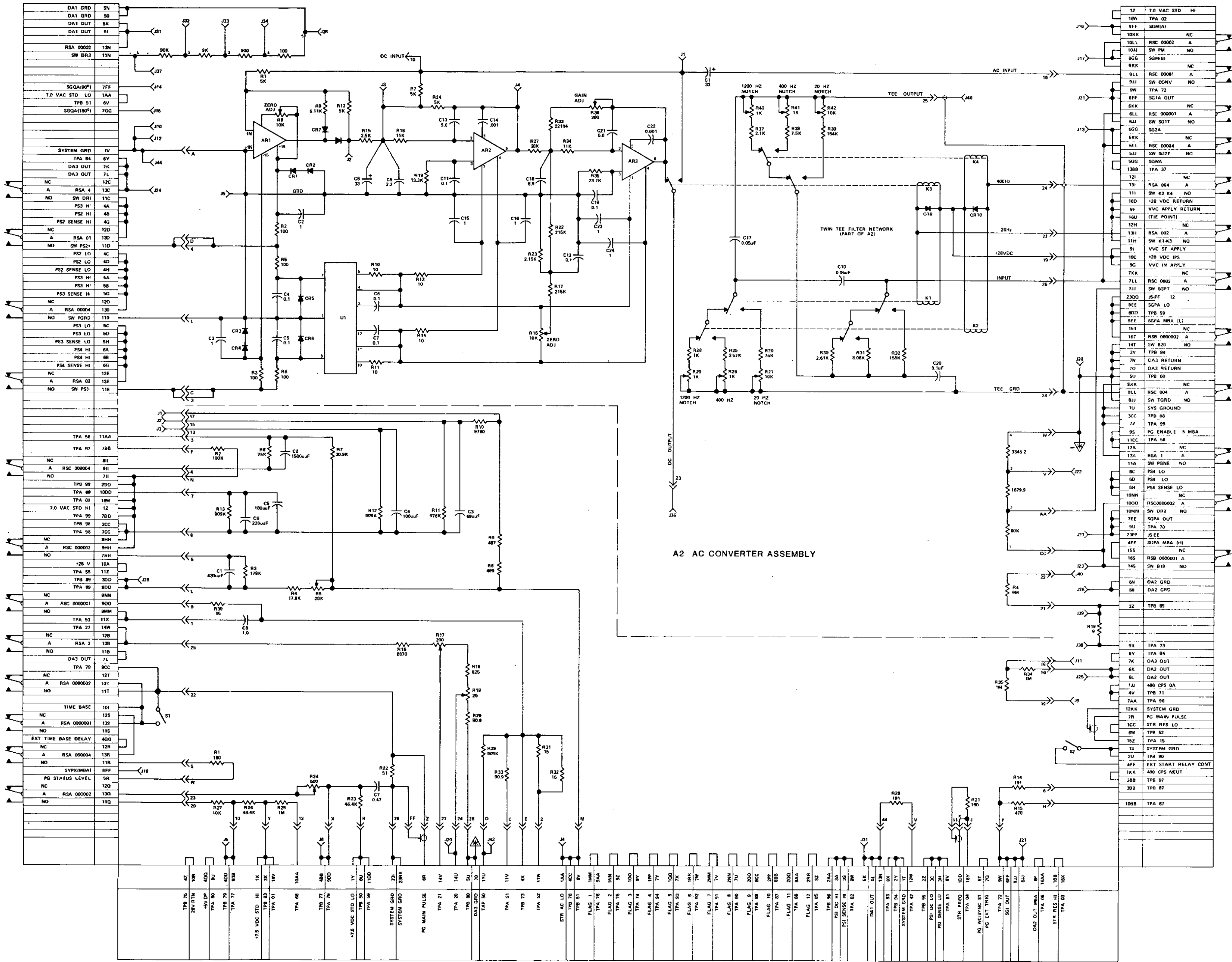

UUT

THIS UNIT IS NOT REMOVED FOR TESTING - IT IS CHECKED IN ITS POSITION IN THE CONSOLE. THERE ARE NO EXTERNAL CABLE CONNECTIONS BETWEEN THE UUT AND THE PATCHBOARD. CONNECTIONS BETWEEN THE UUT AND THE TEST ADAPTER ARE ACCOMPLISHED THRU THE CONSOLE OR WITH PROBES AS DIRECTED BY PROGRAM.

Figure 2-10. UUT 9260, waveform converter interconnection diagram.

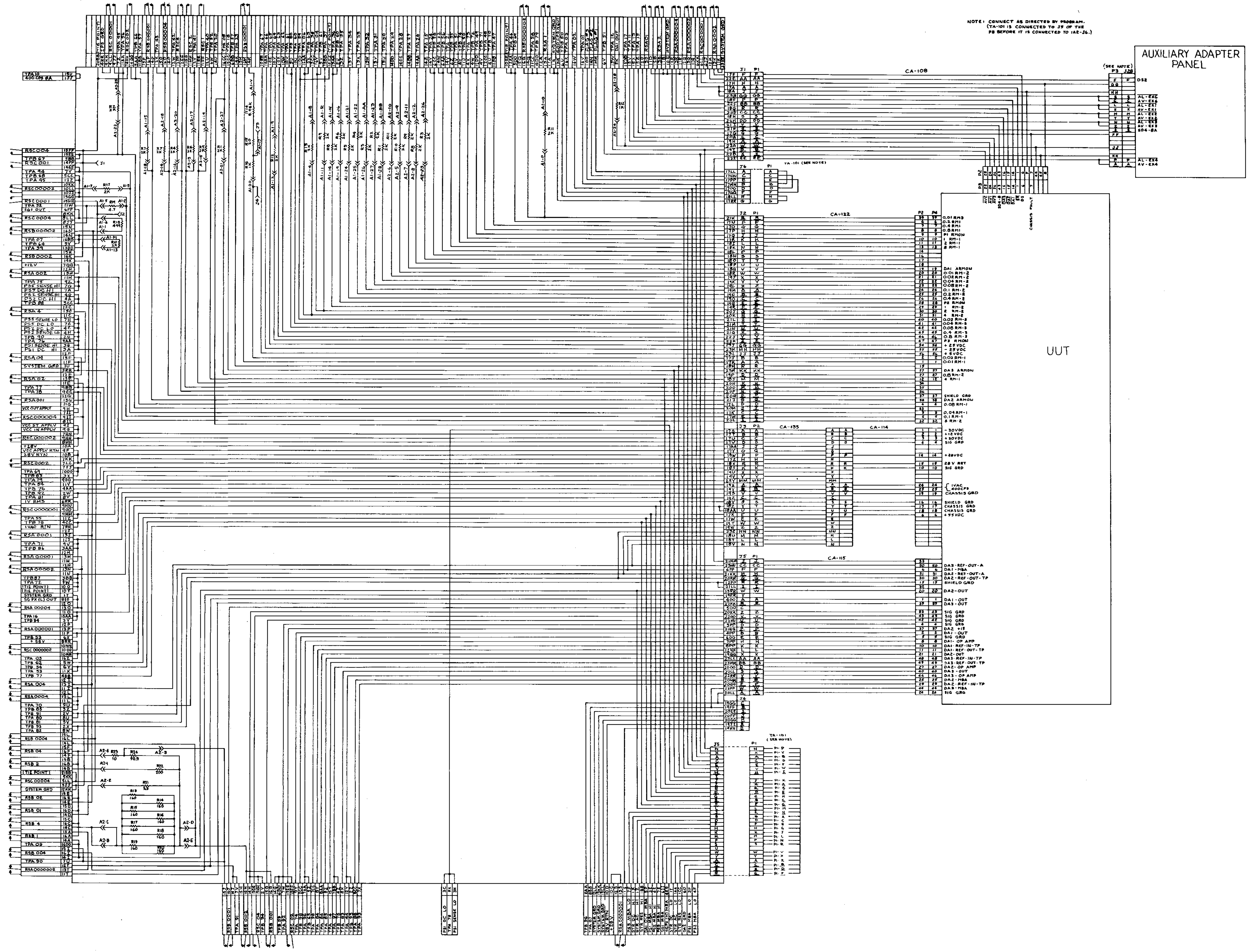

Figure 2-11. UUT 9280, 0-10 VDC Reference Power Supply Interconnection Diagram.

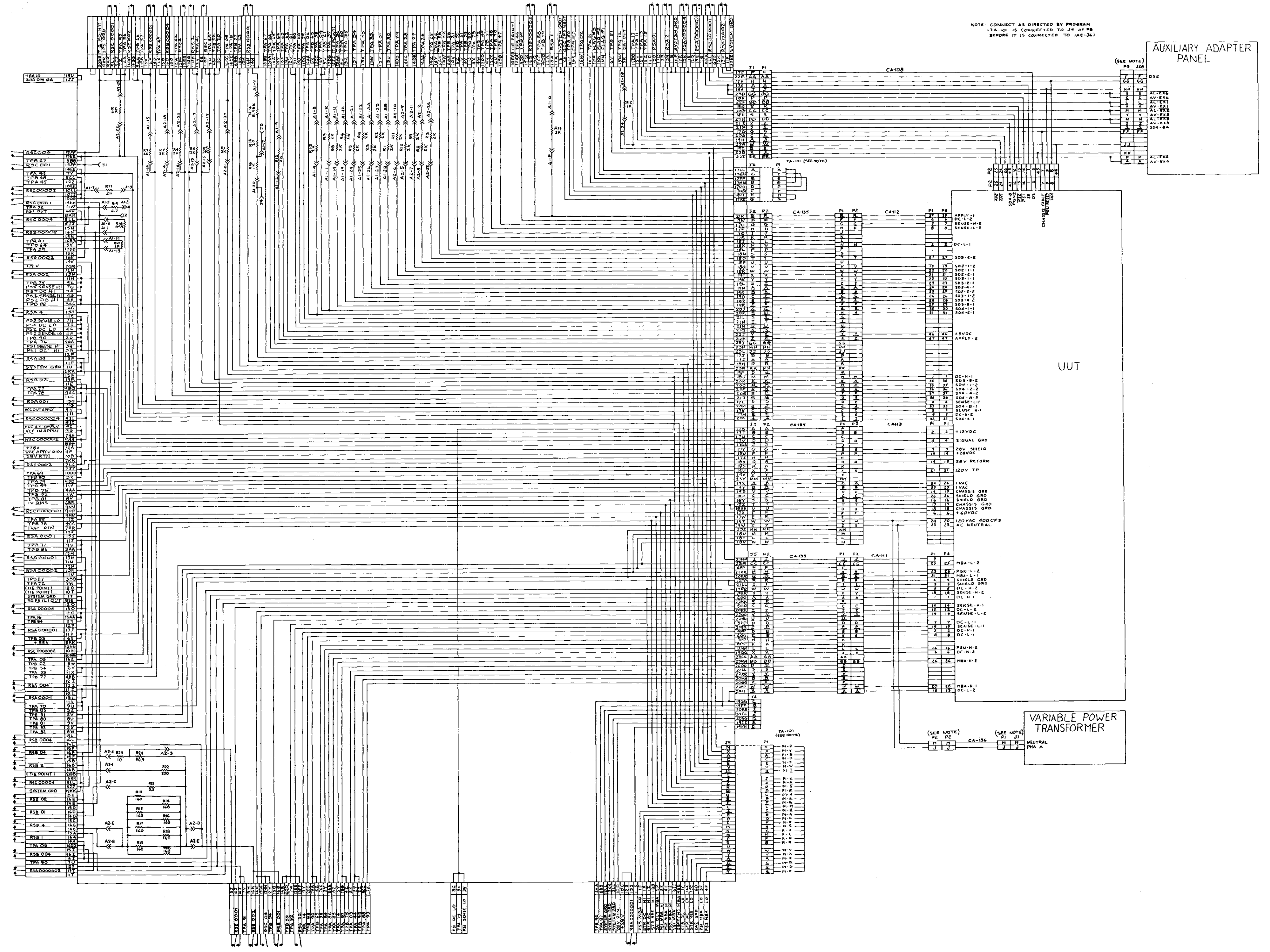

Figure 2-12. UUT 9290, 0-40 VDC Programmable Power Supply Interconnection Diagram

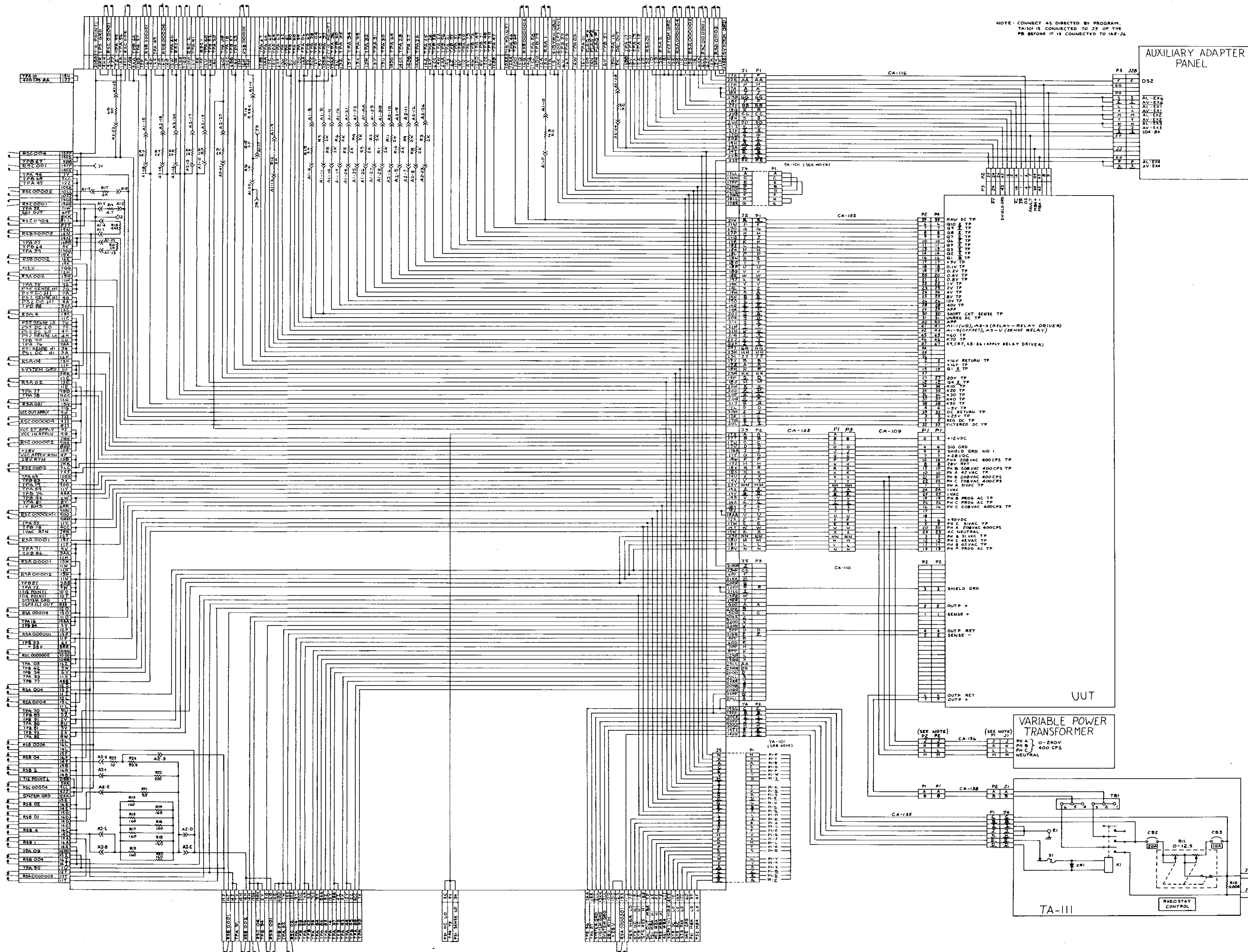

Figure 2-13. UUT 9310, 5-50 VDC Programmable Power Supply Interconnection Diagram.



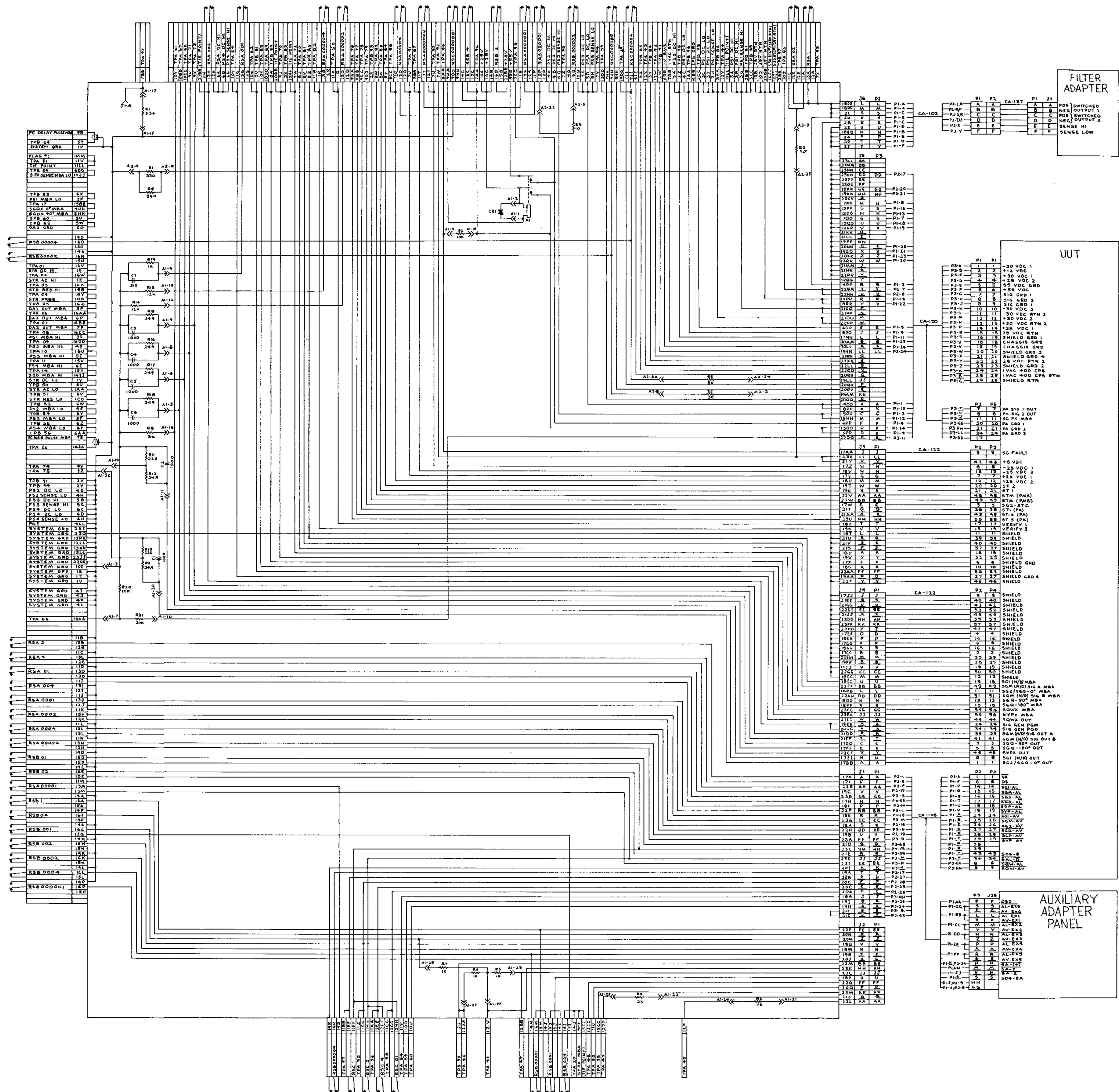

Figure 2-14. UUT 9320, Signal Generator Interconnection Diagram.

C8

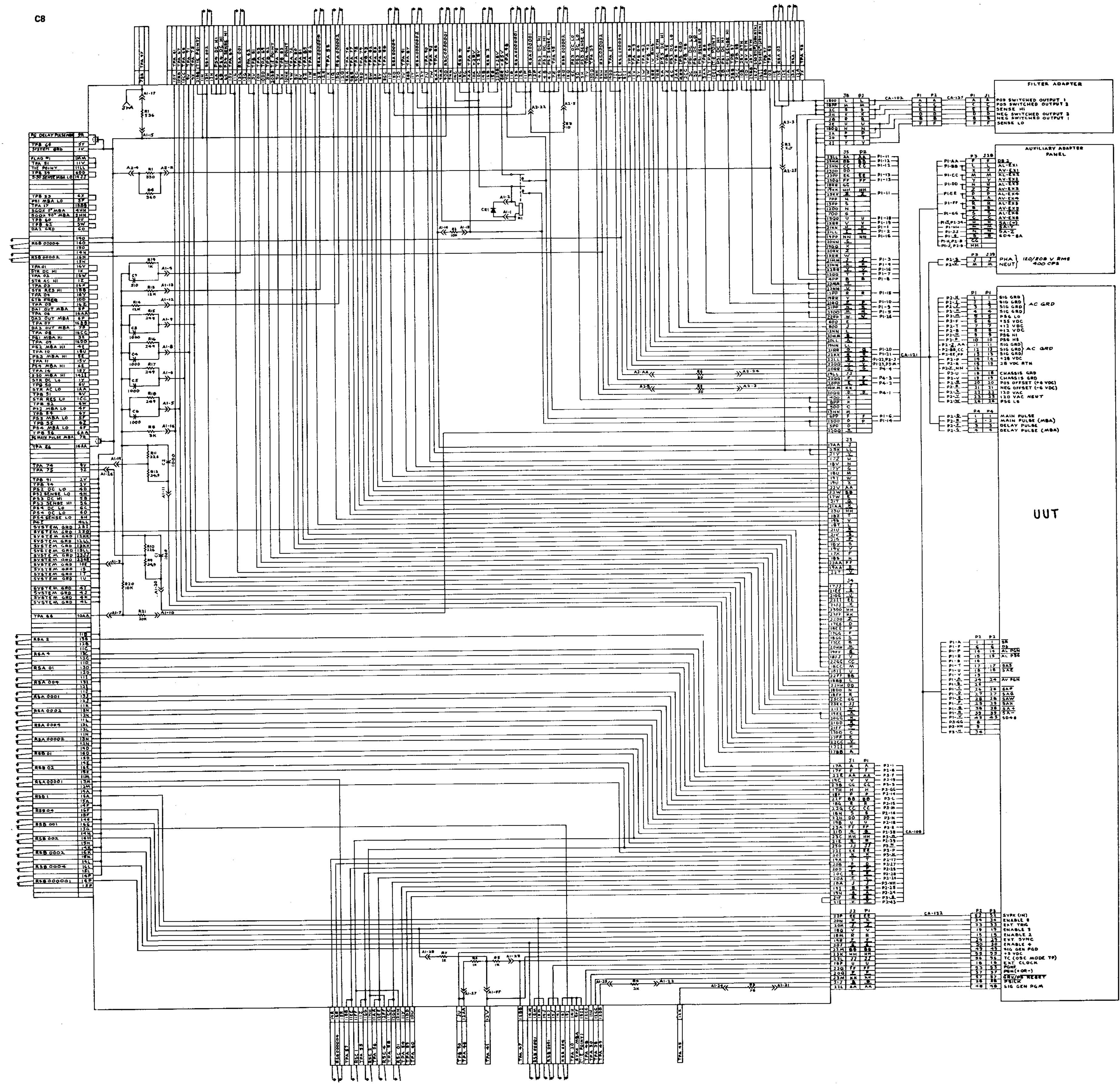

Figure 2-15. UUT 9340, Pulse Generator Interconnection Diagram.

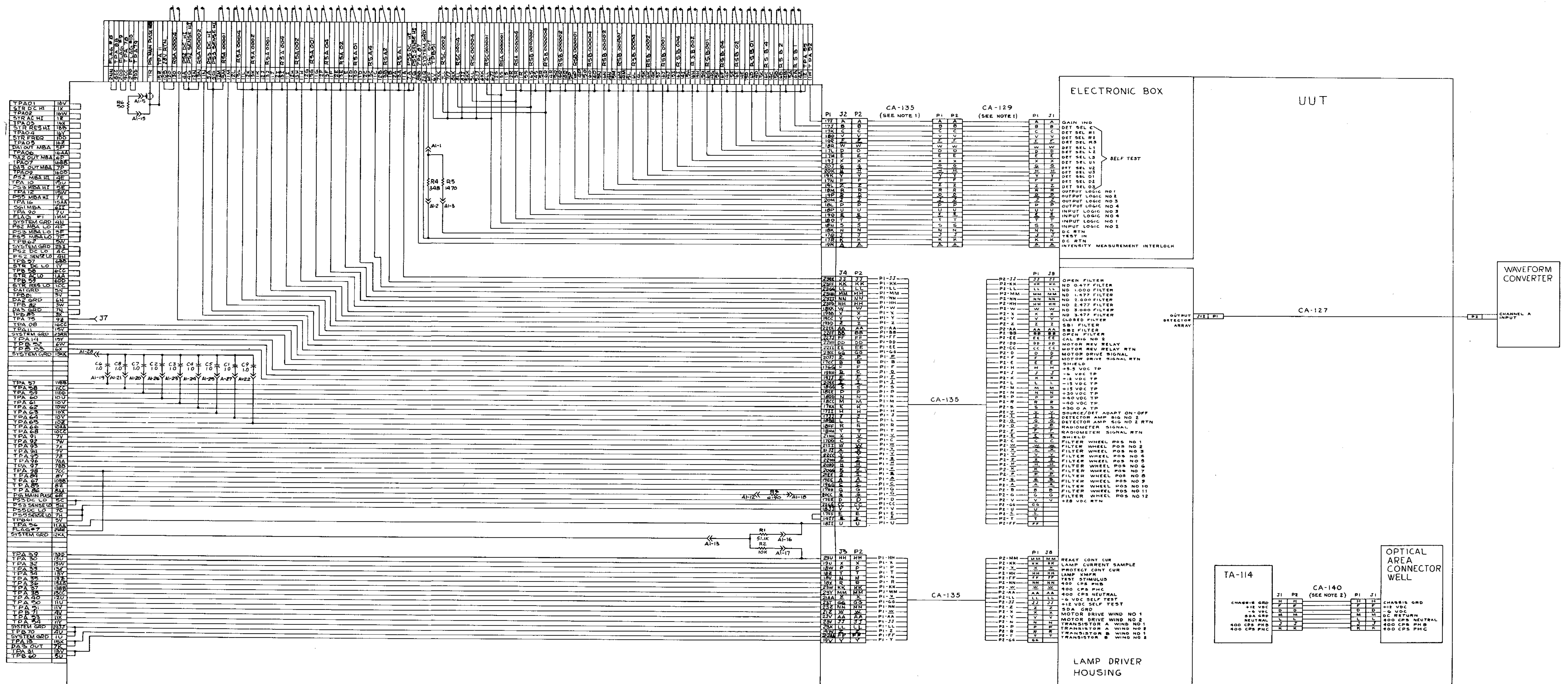

Figure 2-17. UUT 9700, Source/Detector Adapter Interconnection Diagram.

NOTES:  
 1. CONNECT AS DIRECTED BY PROGRAM.  
 2. DISCONNECT AS DIRECTED BY PROGRAM.

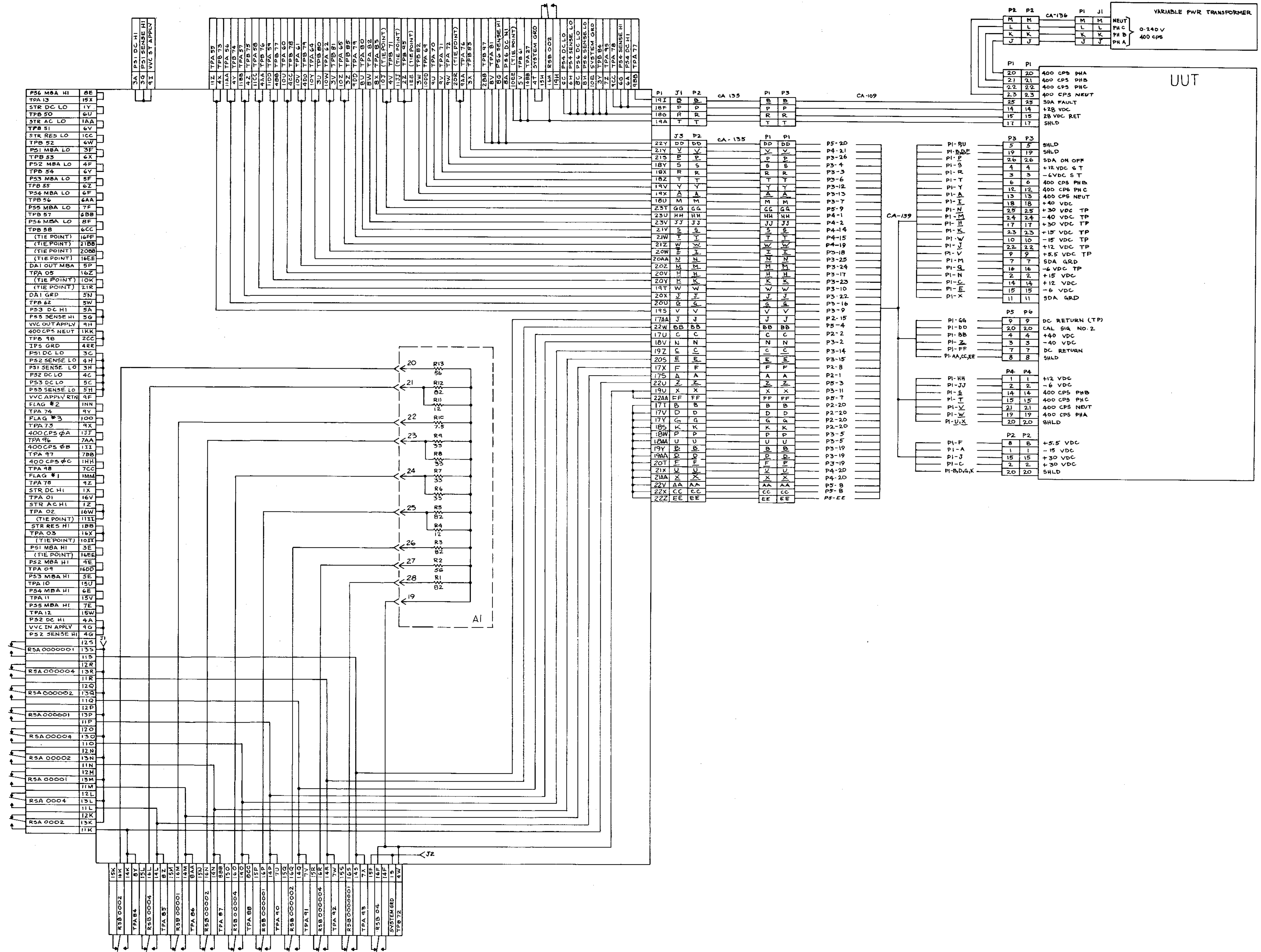

Figure 2-18. UUT 9740, Source/Detector Adapter Power Supply Interconnection Diagram.

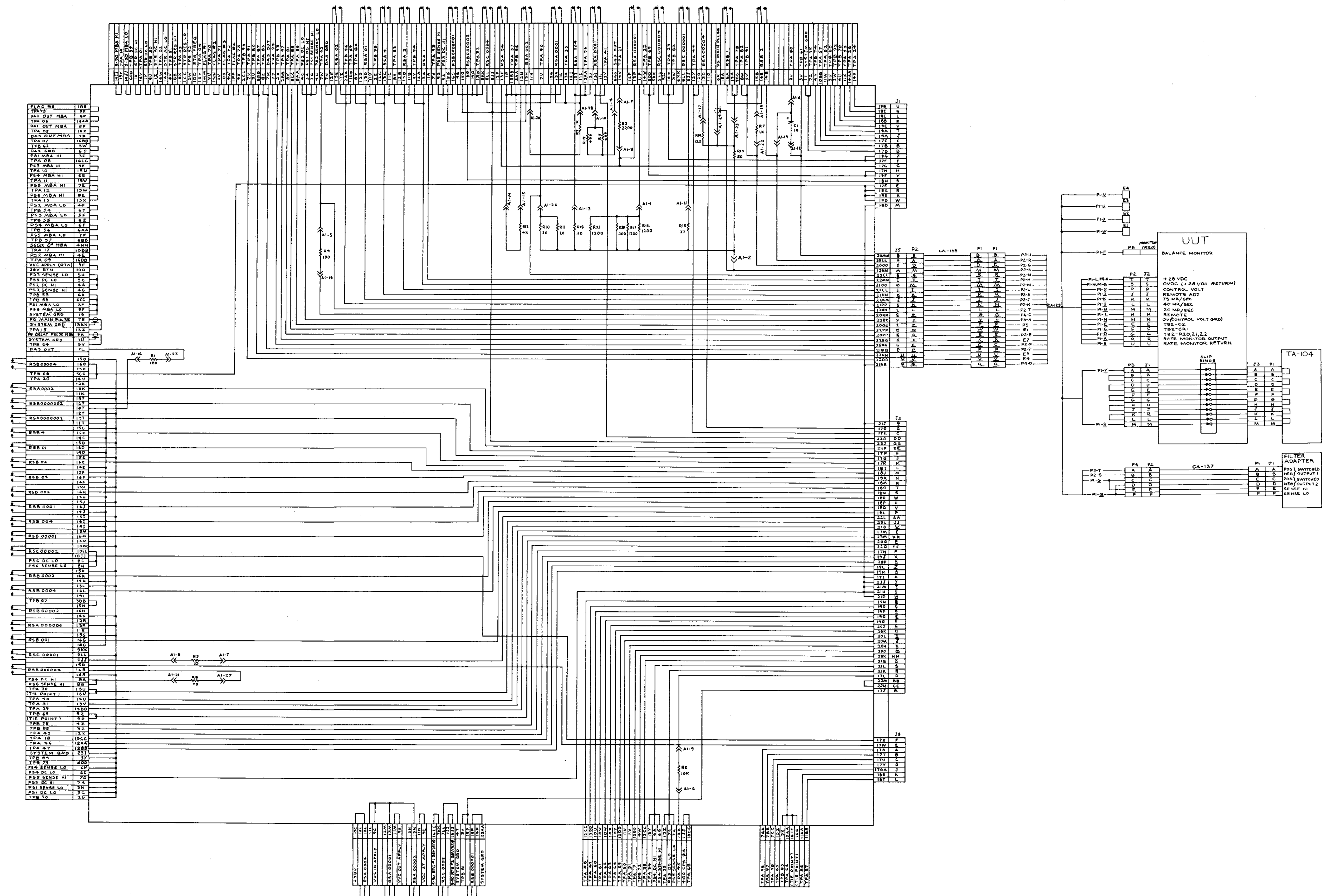
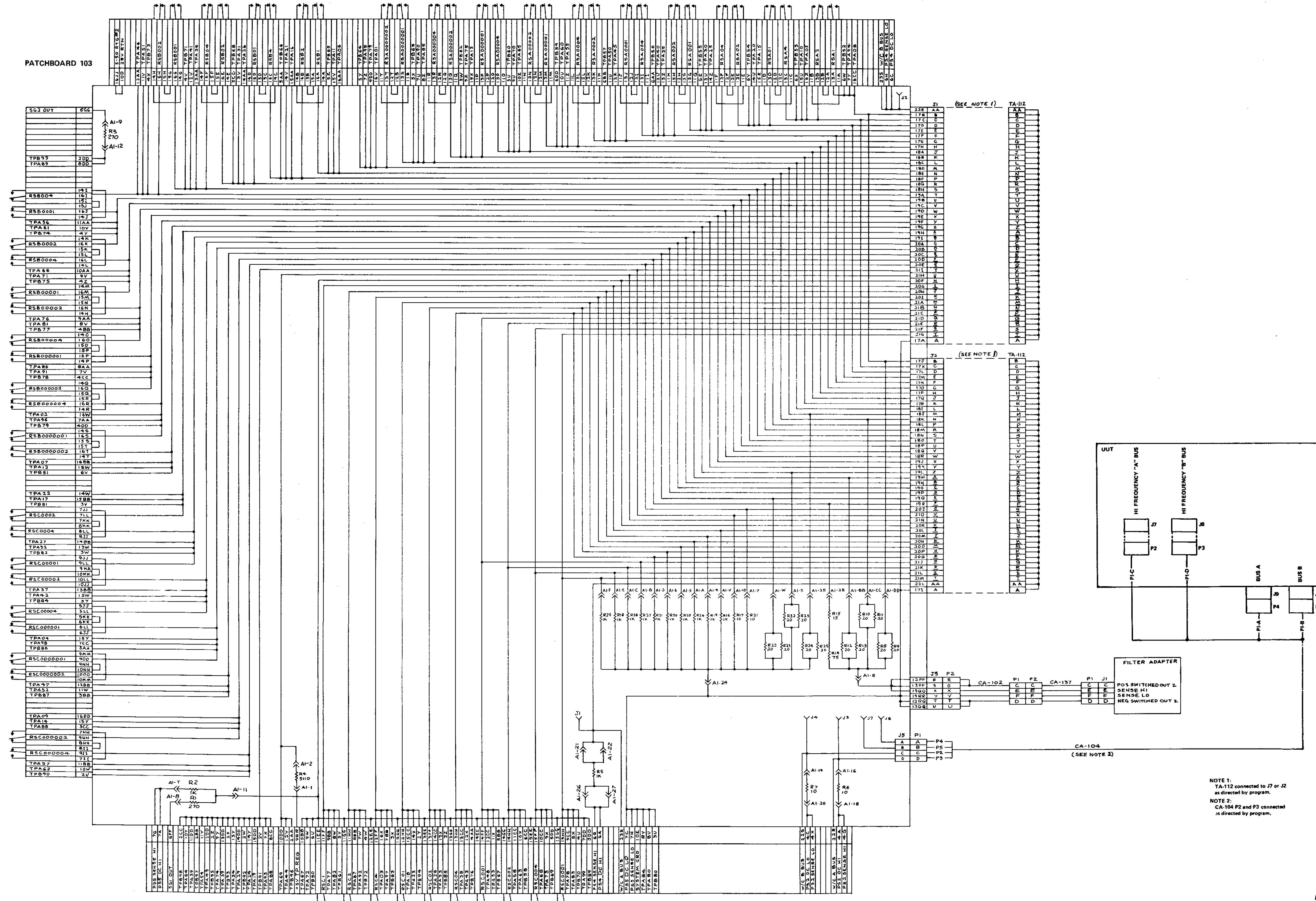

Figure 2-19. UUT 9540, Rate Gyro Table Interconnection Diagram.



NOTE 1:  
TA-112 connected to J7 or J2  
as directed by program.

NOTE 2:  
CA-104 P2 and P3 connected  
as directed by program.

Figure 2-20. UUT 9720, test adapter interconnection diagram.

Section II. UTILIZING SQUIB TYPE PATCHBOARDS

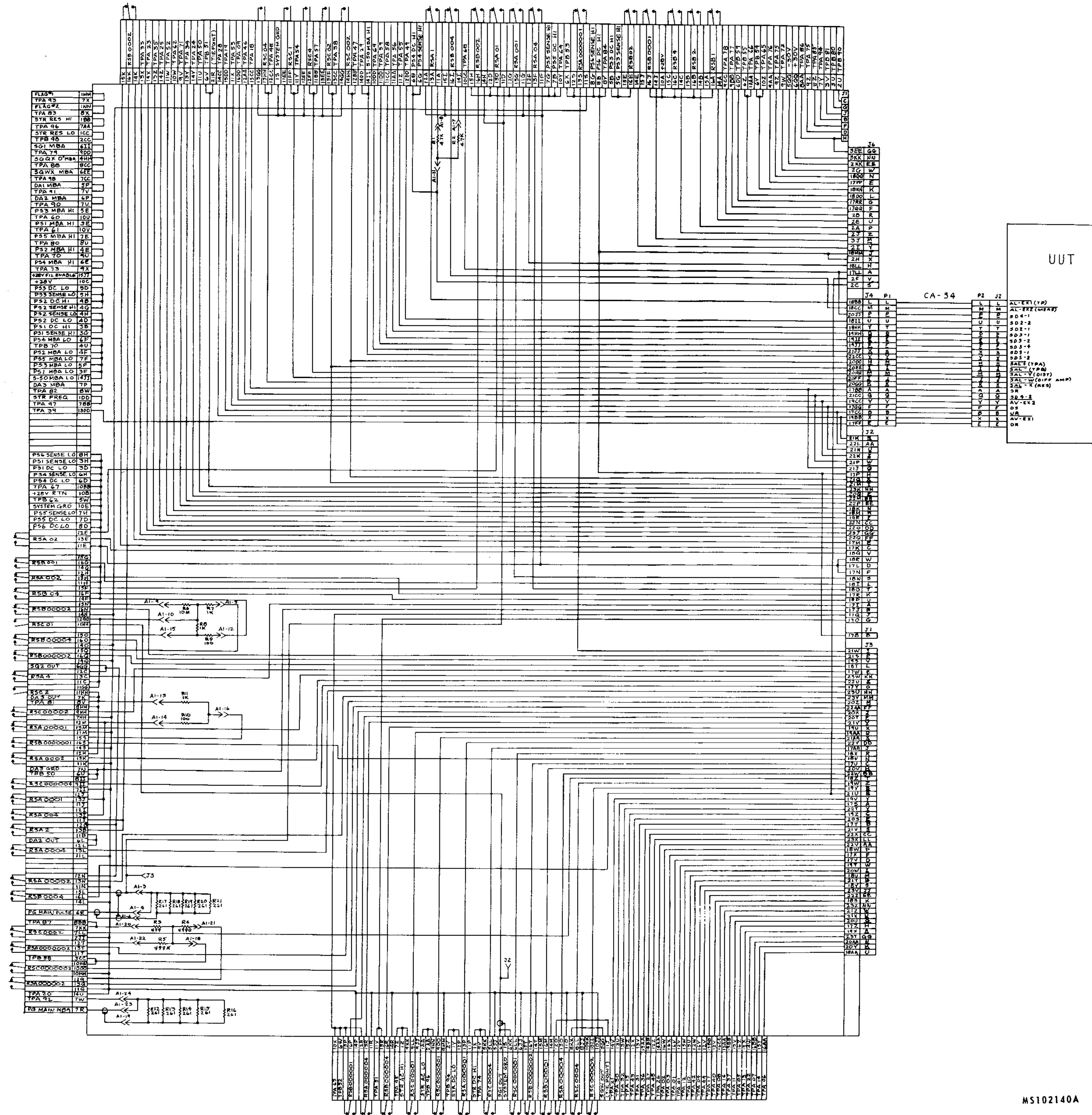

Figure 2-21. UUT 9570, Programmable Signal Conditioner Interconnection Diagram.

MS102140A

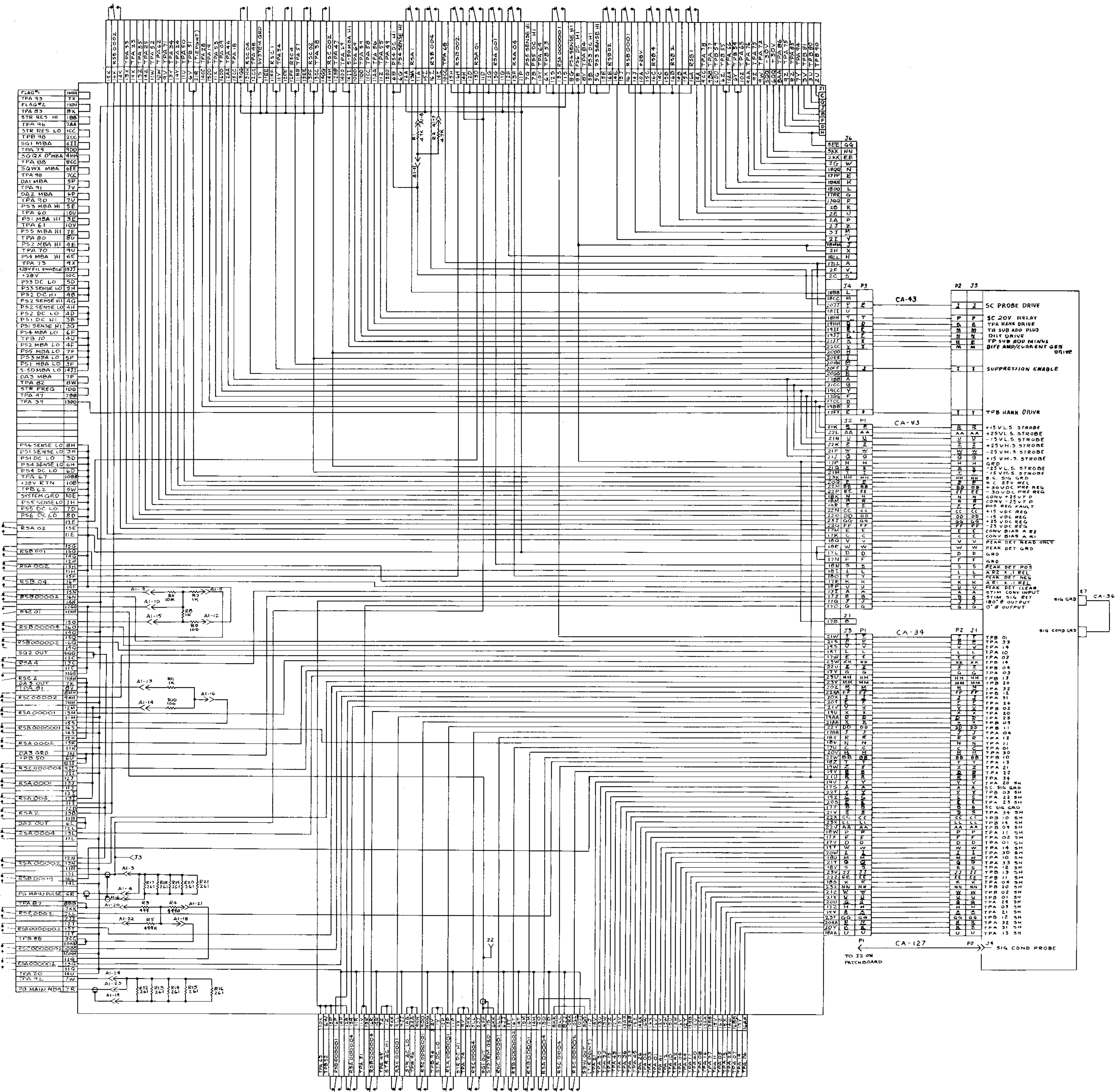

Figure 2-22 UUT 9570, Programmable Signal Conditioner (Go-Chain Cable Changes) Interconnection Diagram.



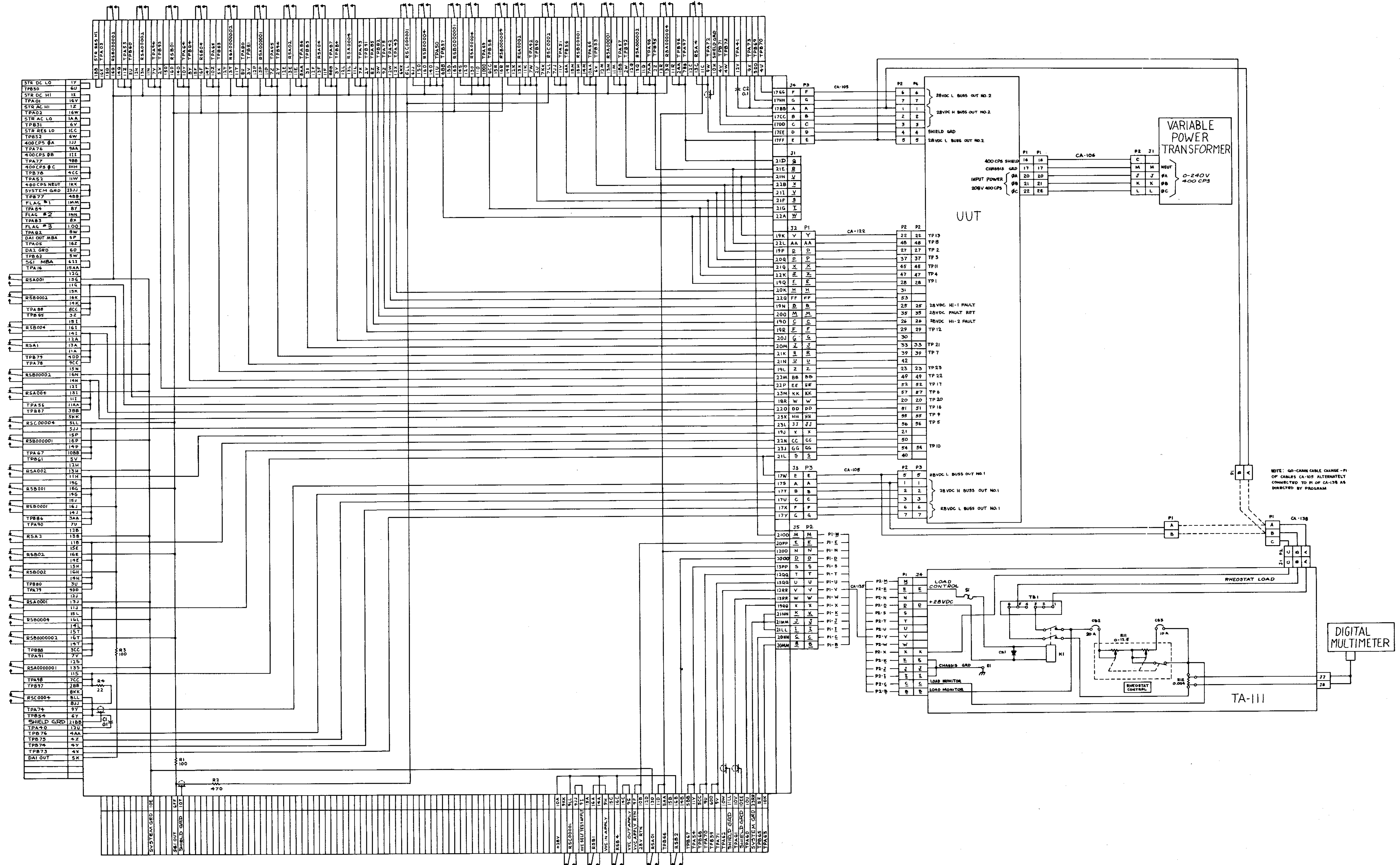

Figure 2-23. UUT 9060, 28 VDC Dual Power Supply Interconnection Diagram.

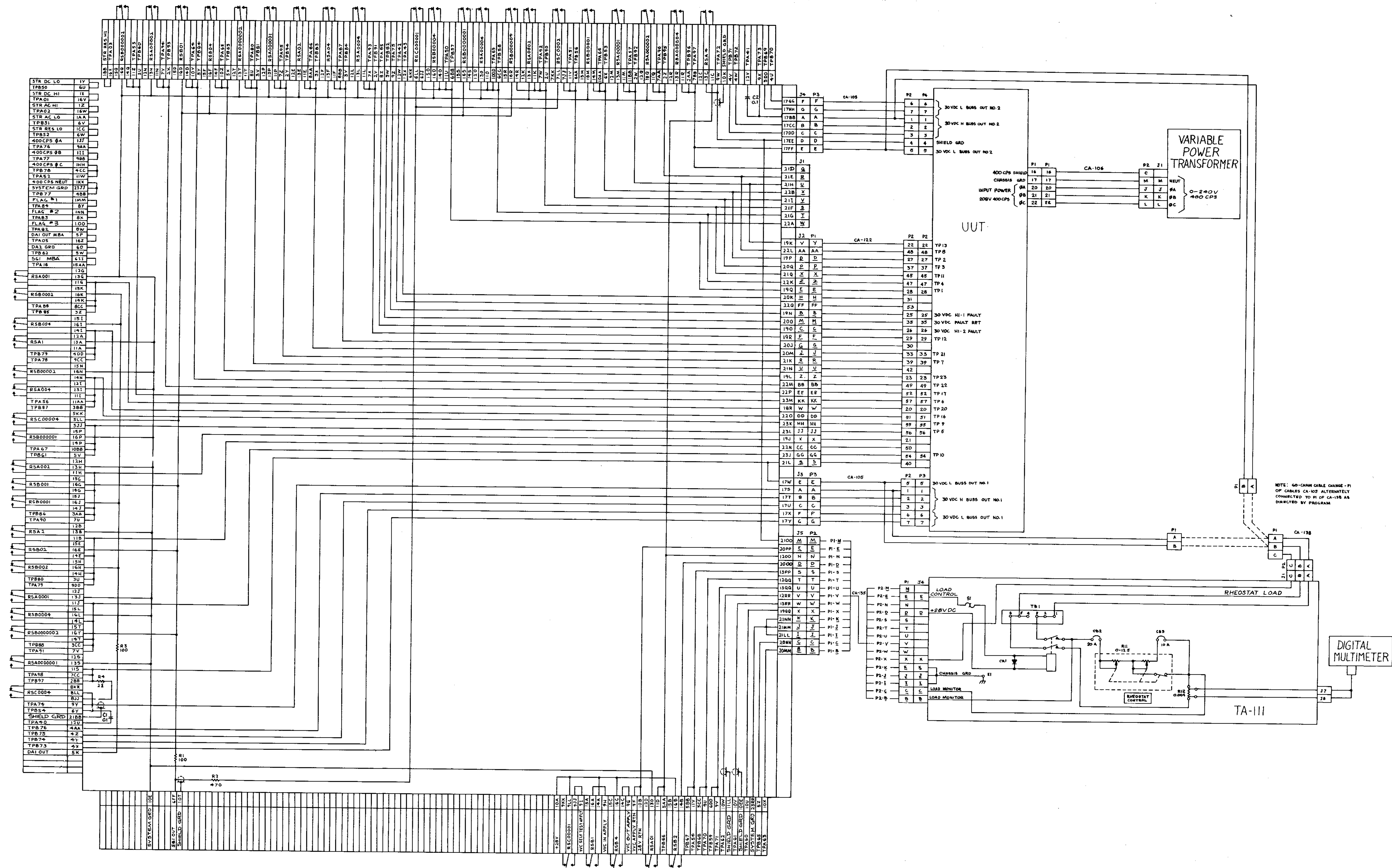

Figure 2-24. UUT 9070, 30 VDC Dual Power Supply Interconnection Diagram.

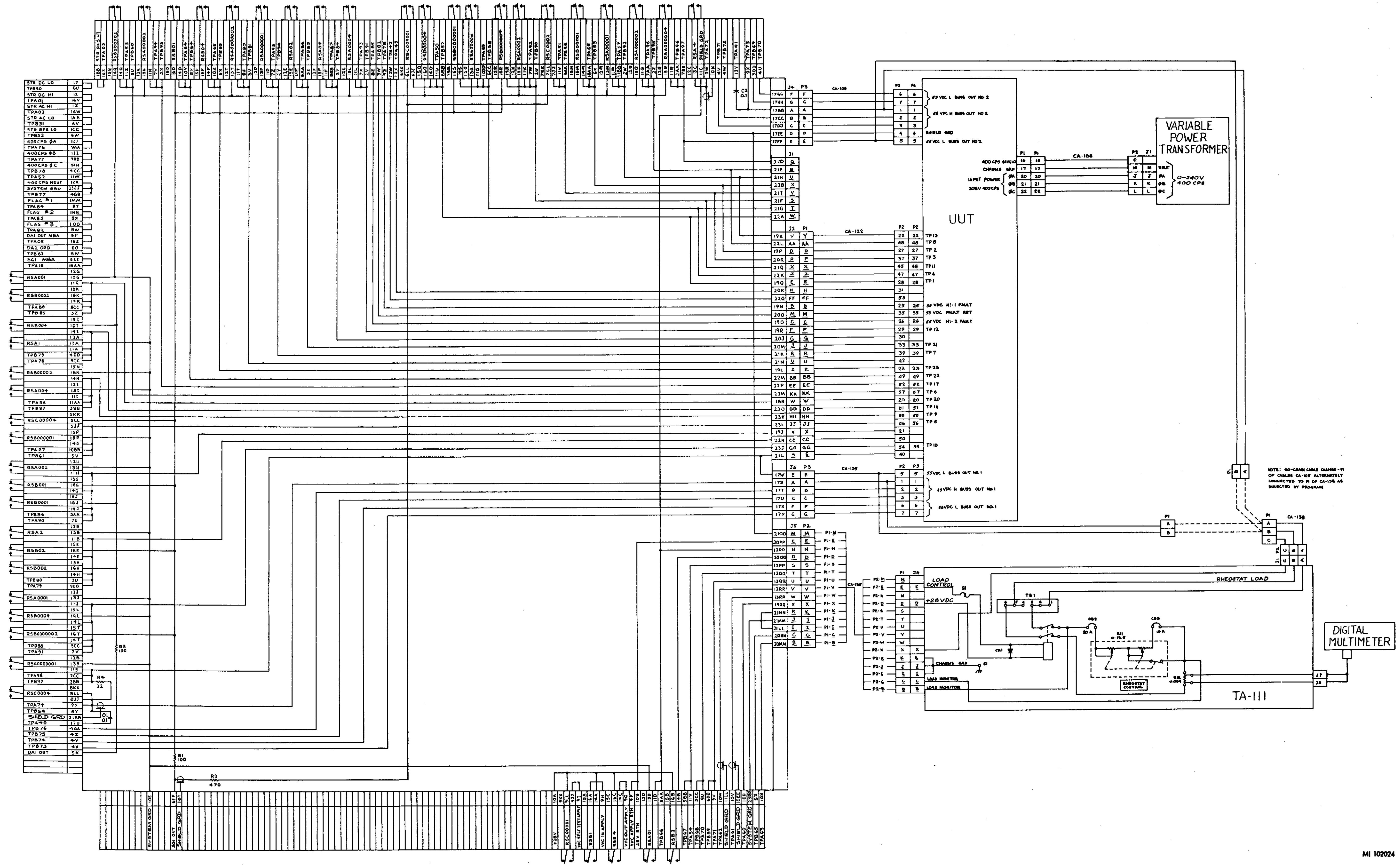

Figure 2-25. UUT 9080, 55 VDC Dual Power Supply Interconnection Diagram.

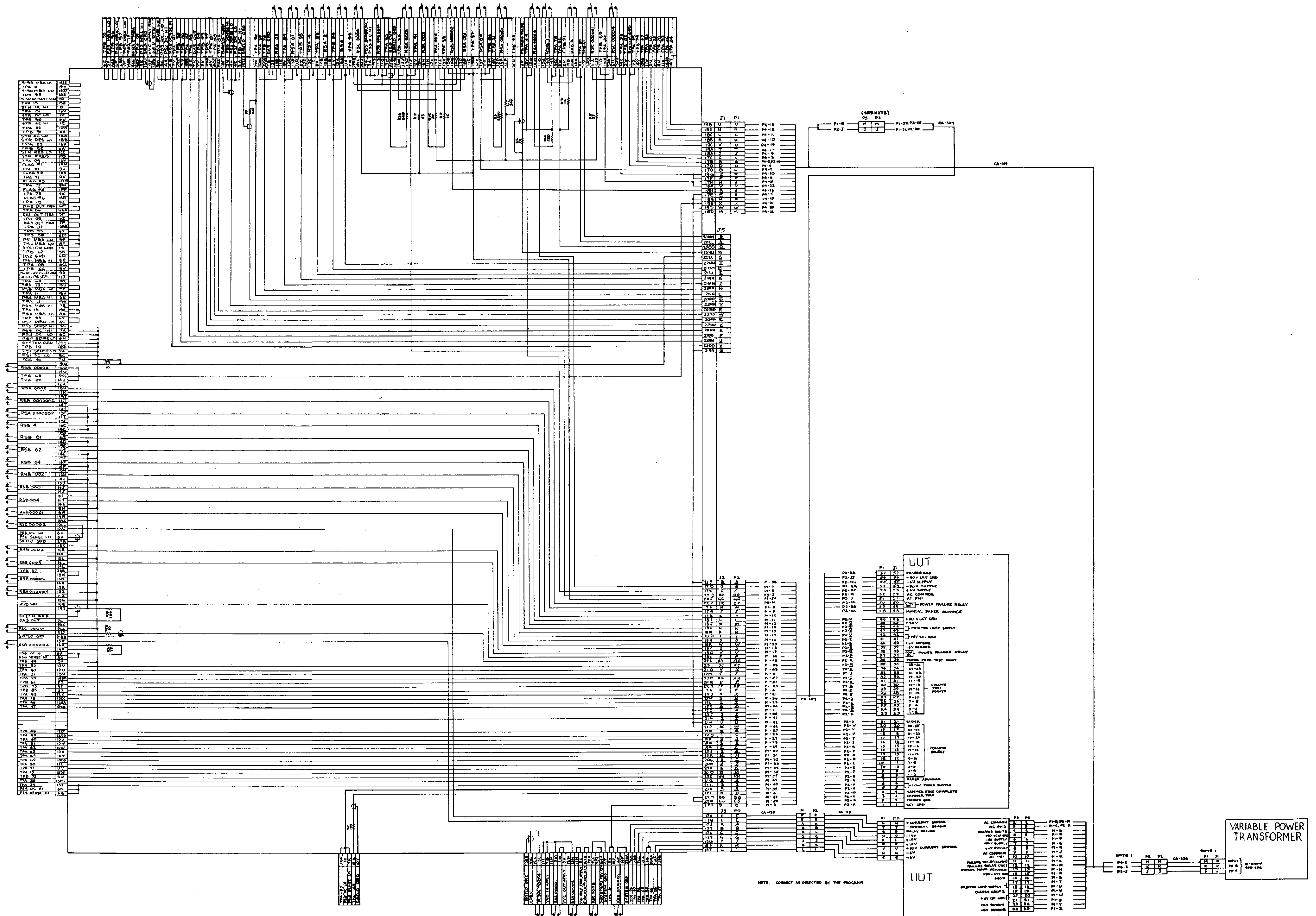

Figure 2-28. UUT 9220, Solid State Visual Display (SSVD) Interconnection Diagram.

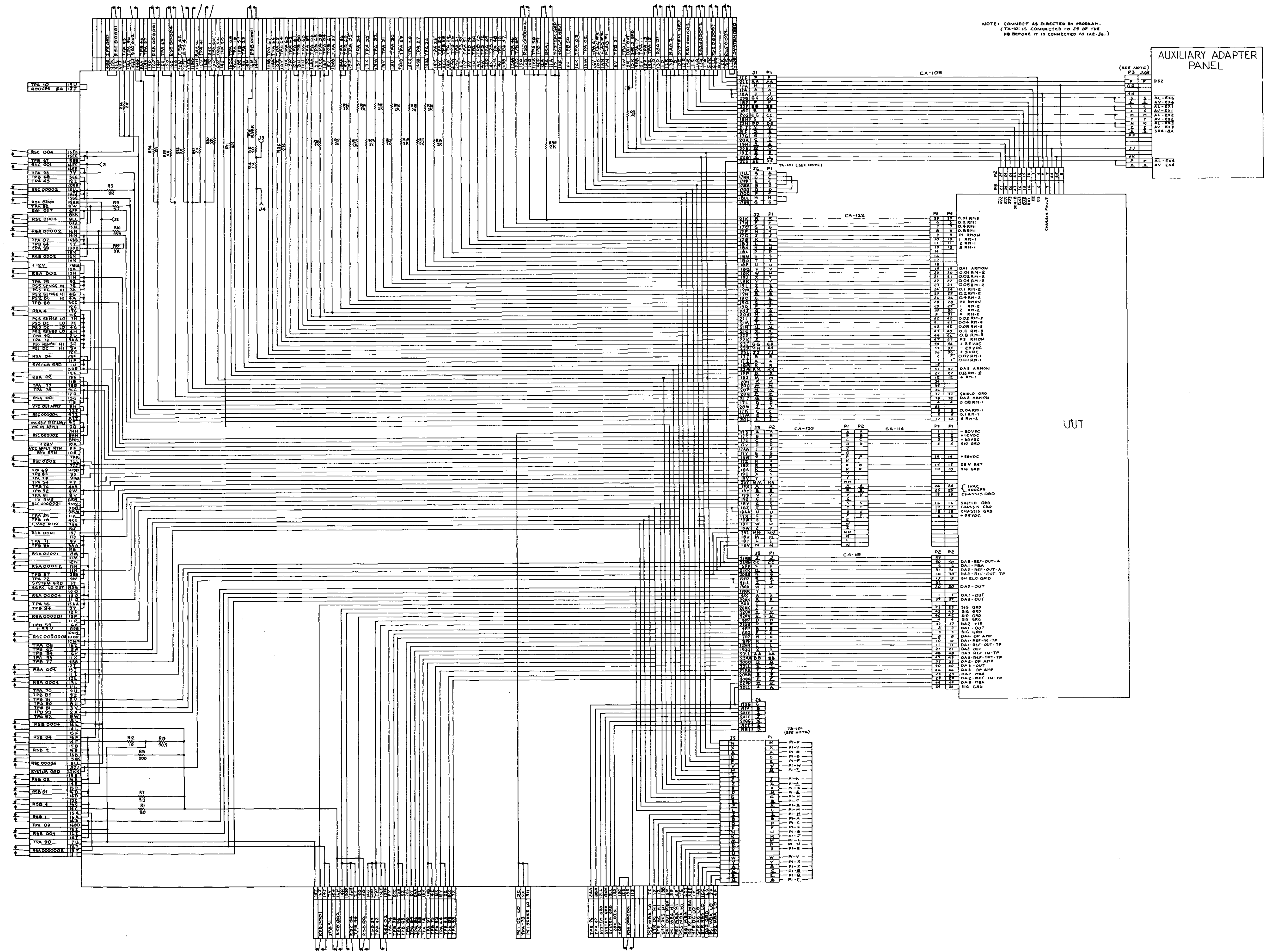

Figure 2-31. UUT 9280, 0-10 VDC Reference Power Supply Interconnection Diagram.

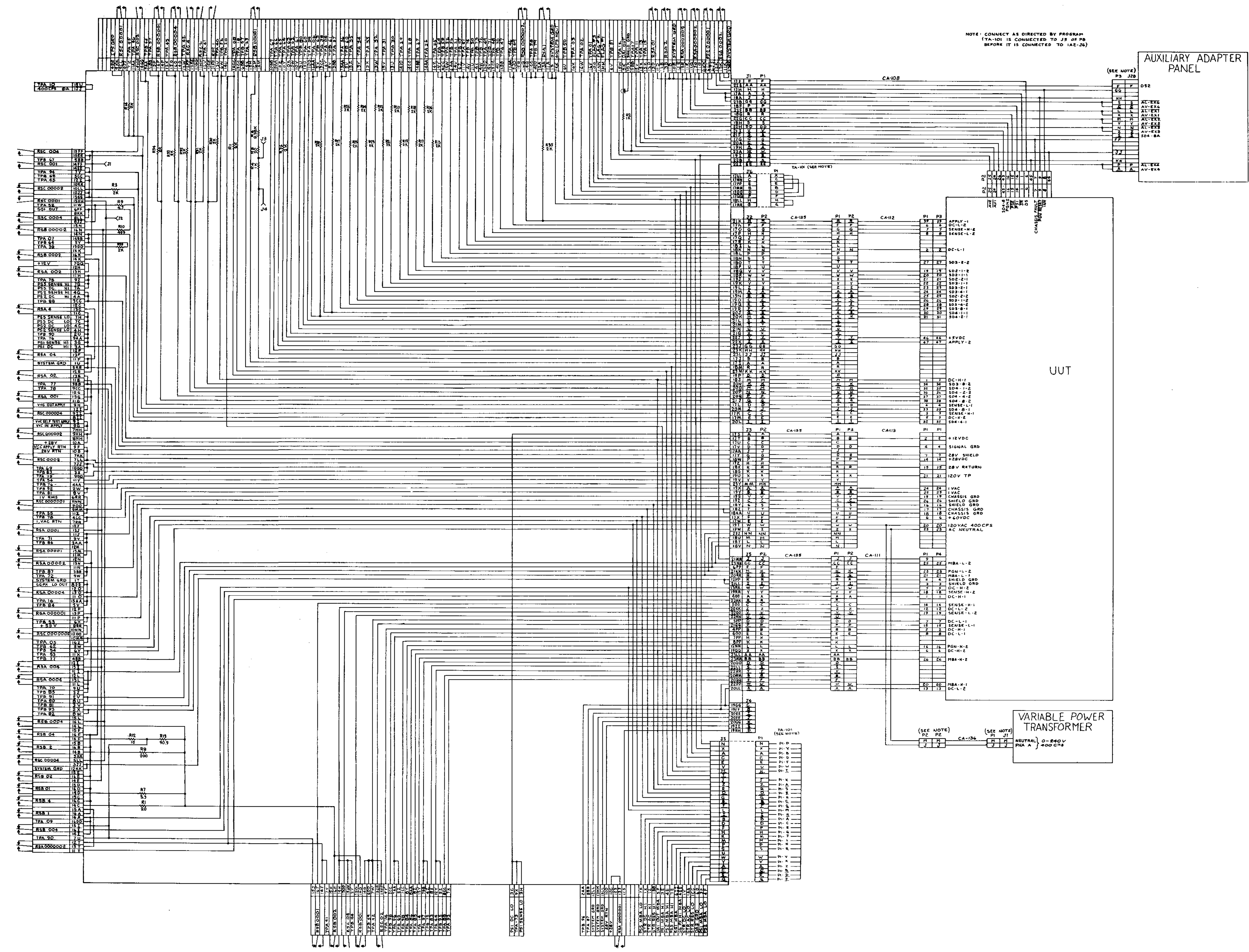

Figure 2-32. UUT 9290, 0-40 VDC Programmable Power Supply Interconnection Diagram.

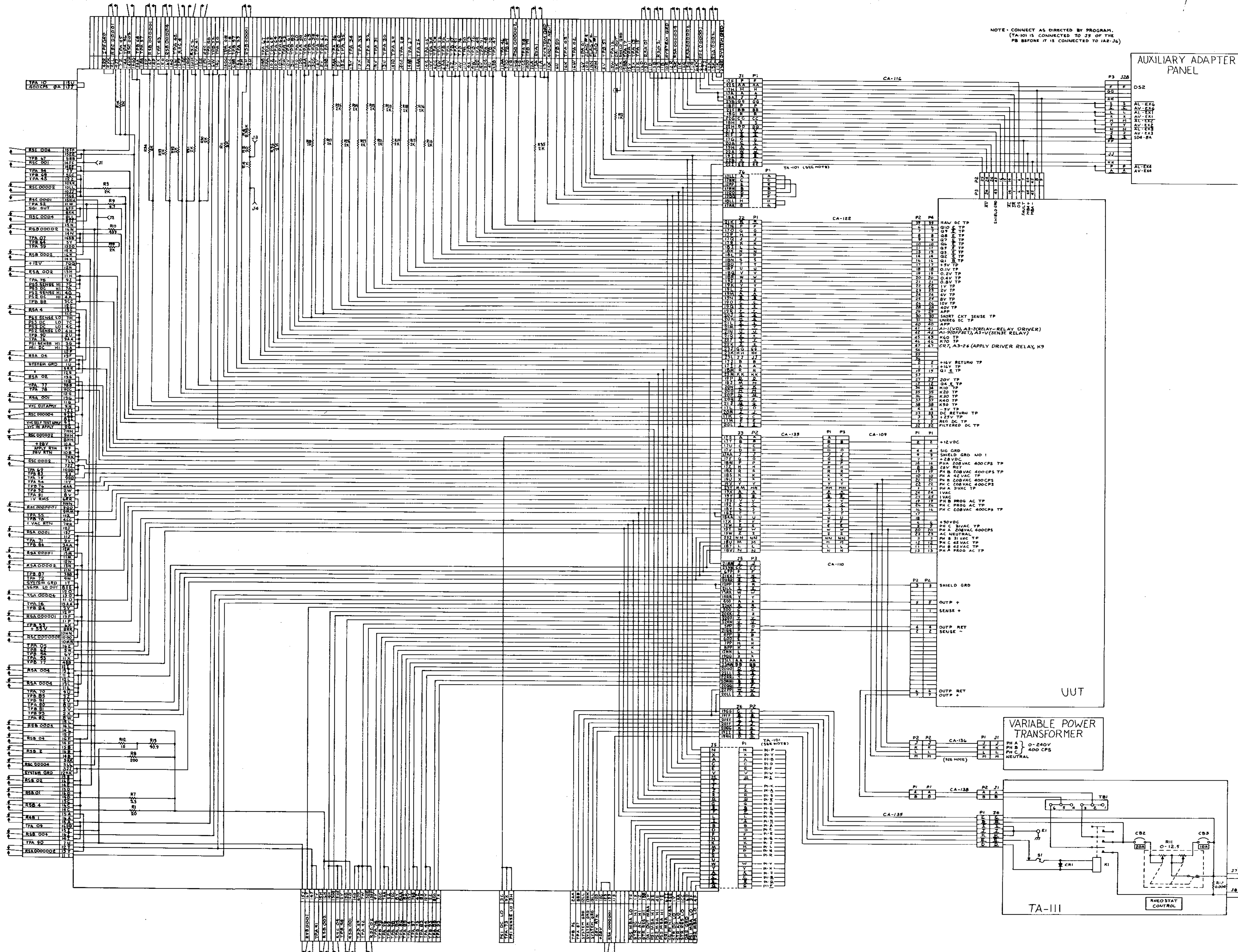

Figure 2-33. UUT 9810, 5-50 VDC Programmable Power Supply Interconnection Diagram.

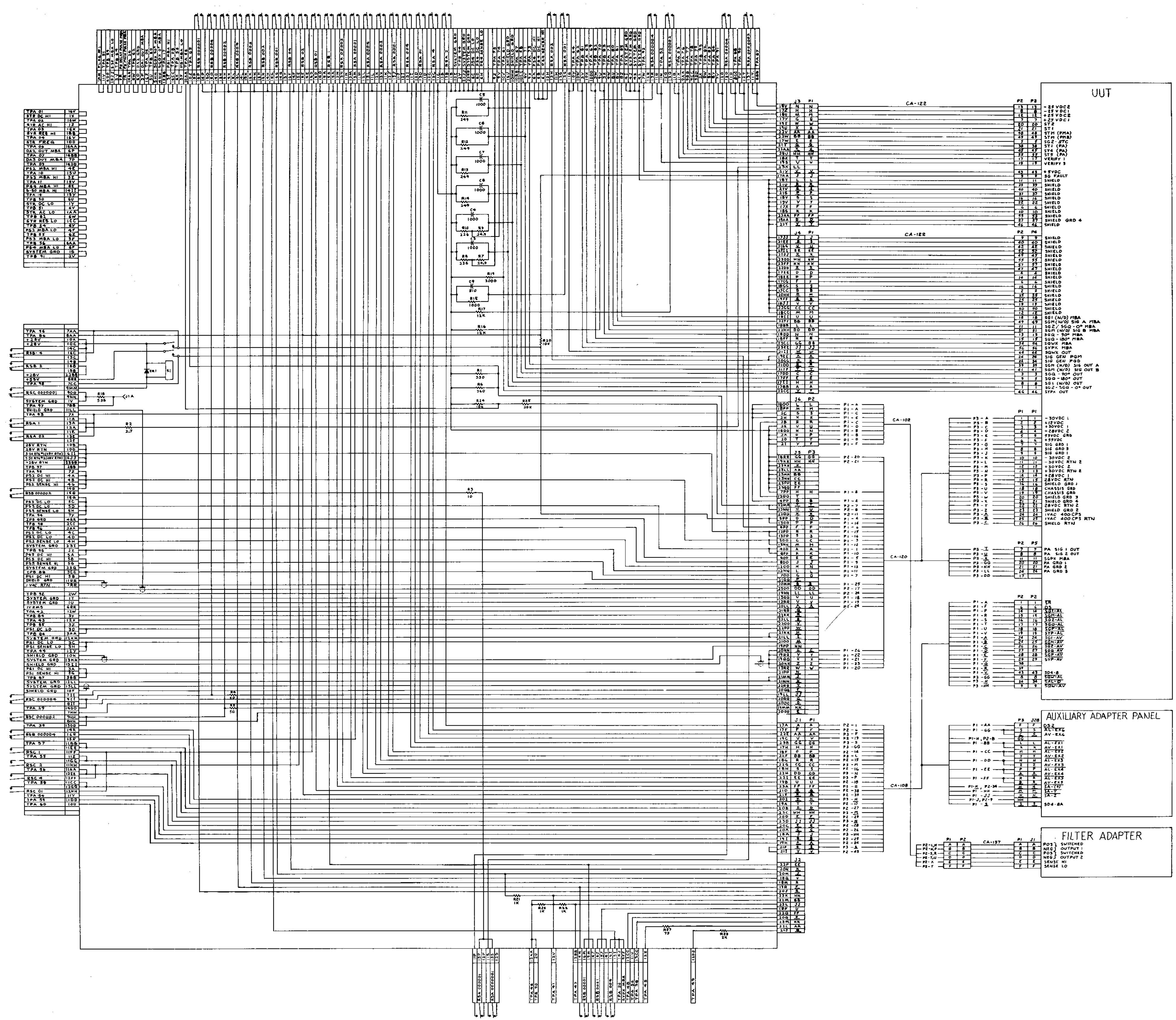

Figure 2-34. UUT 9320, Signal Generator Interconnection Diagram.



C8

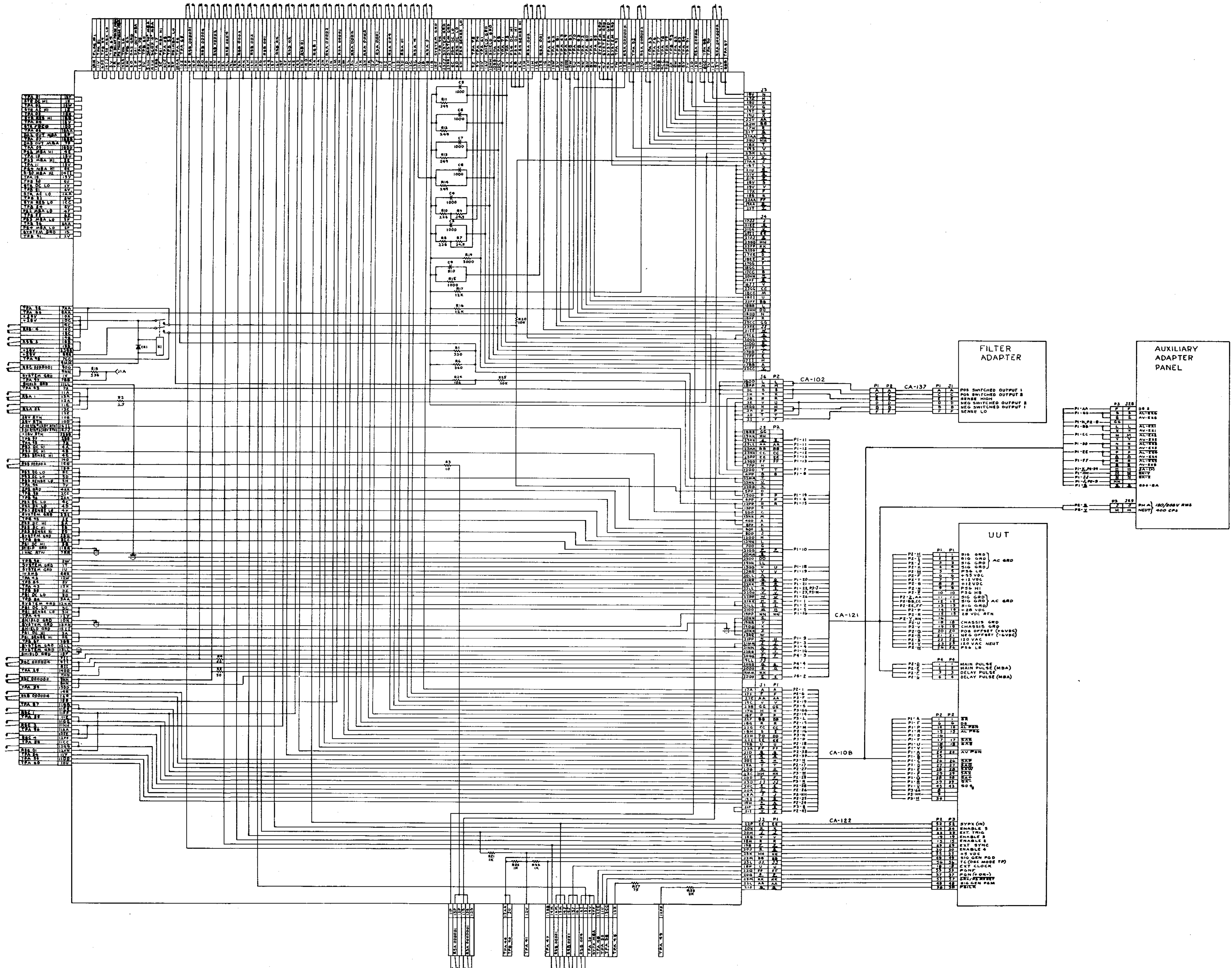

Figure 2-35. UUT 9340, Pulse Generator Interconnection Diagram.

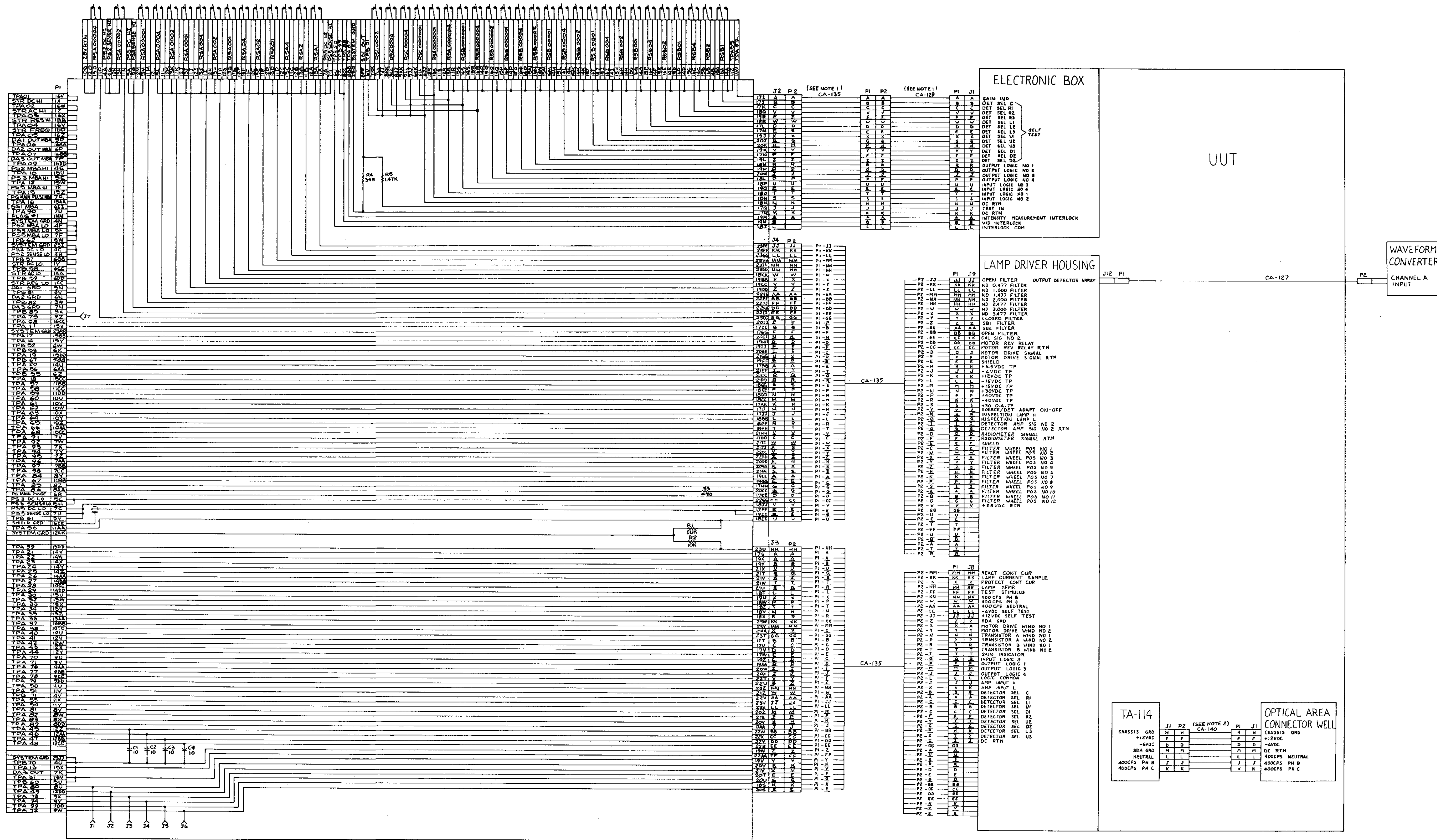

Figure 2-38. UUT 9700, Source/Detector Adapter Interconnection Diagram.

NOTES:  
 1. CONNECT AS DIRECTED BY PROGRAM  
 2. DISCONNECT AS DIRECTED BY PROGRAM

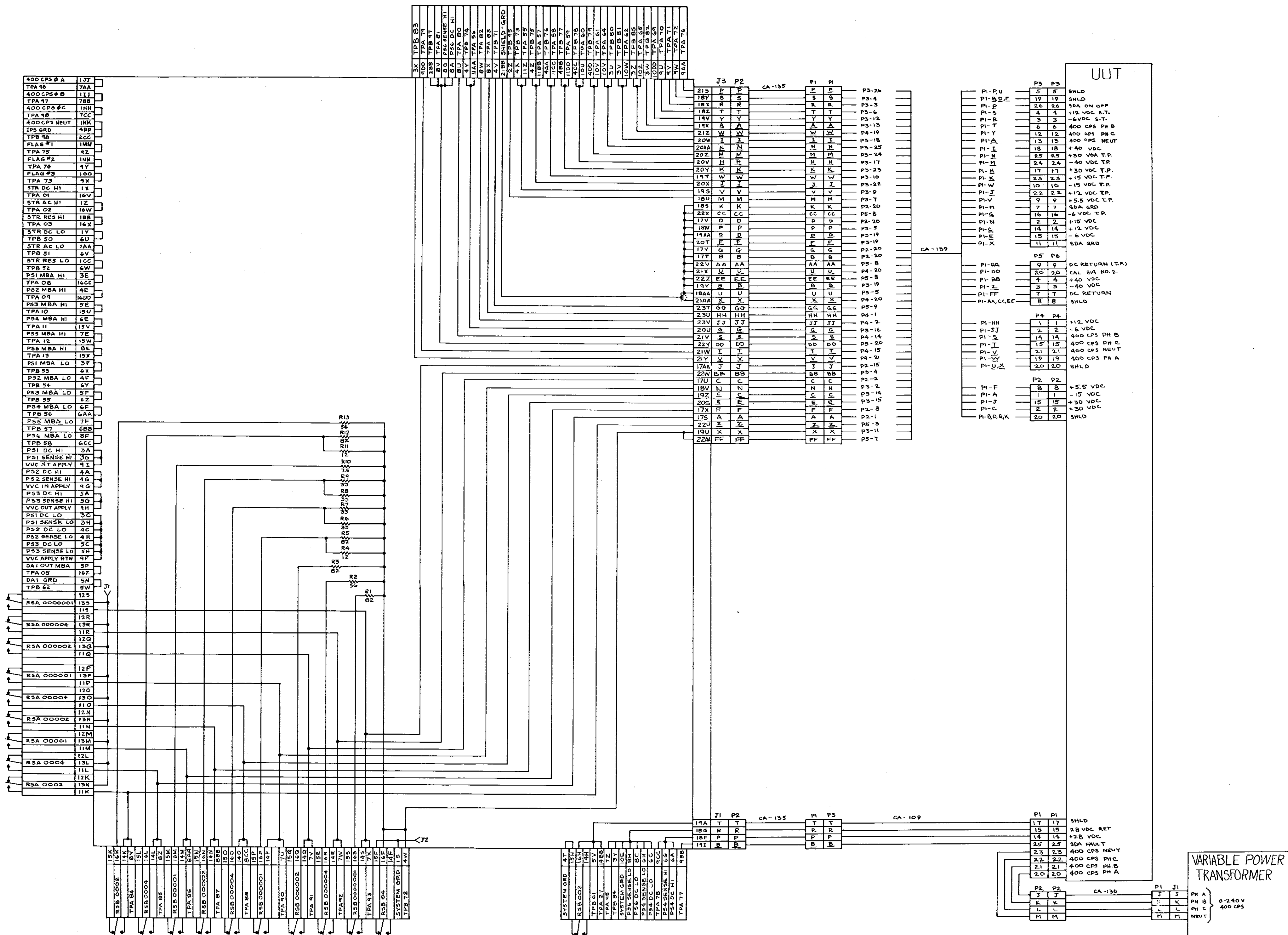

Figure 2-39. UUT 9740, Source/Detector Adapter Power Supply Interconnection Diagram.

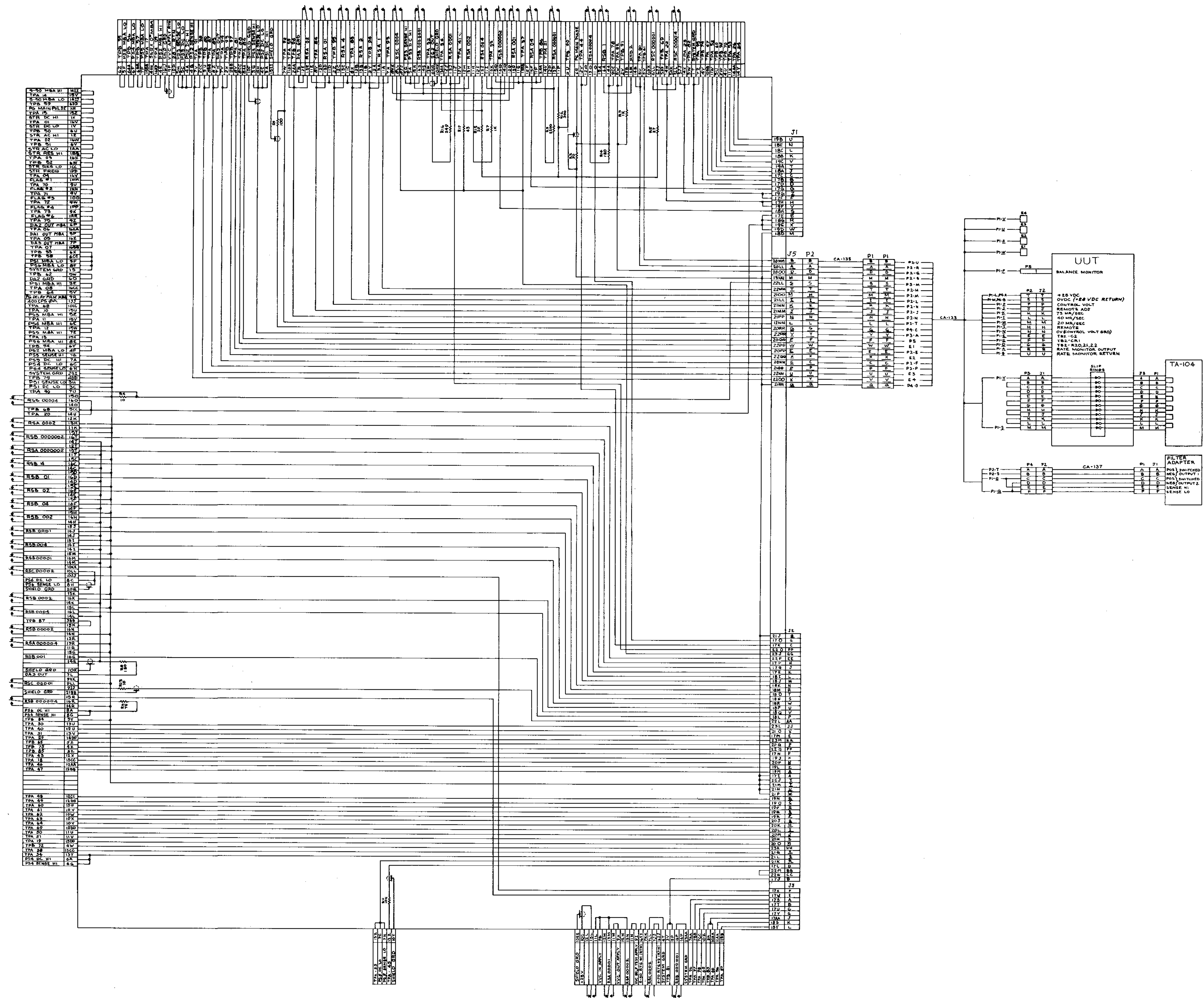

Figure 2-40. UUT 9540, Rate Gyro Table Interconnection Diagram.

C4

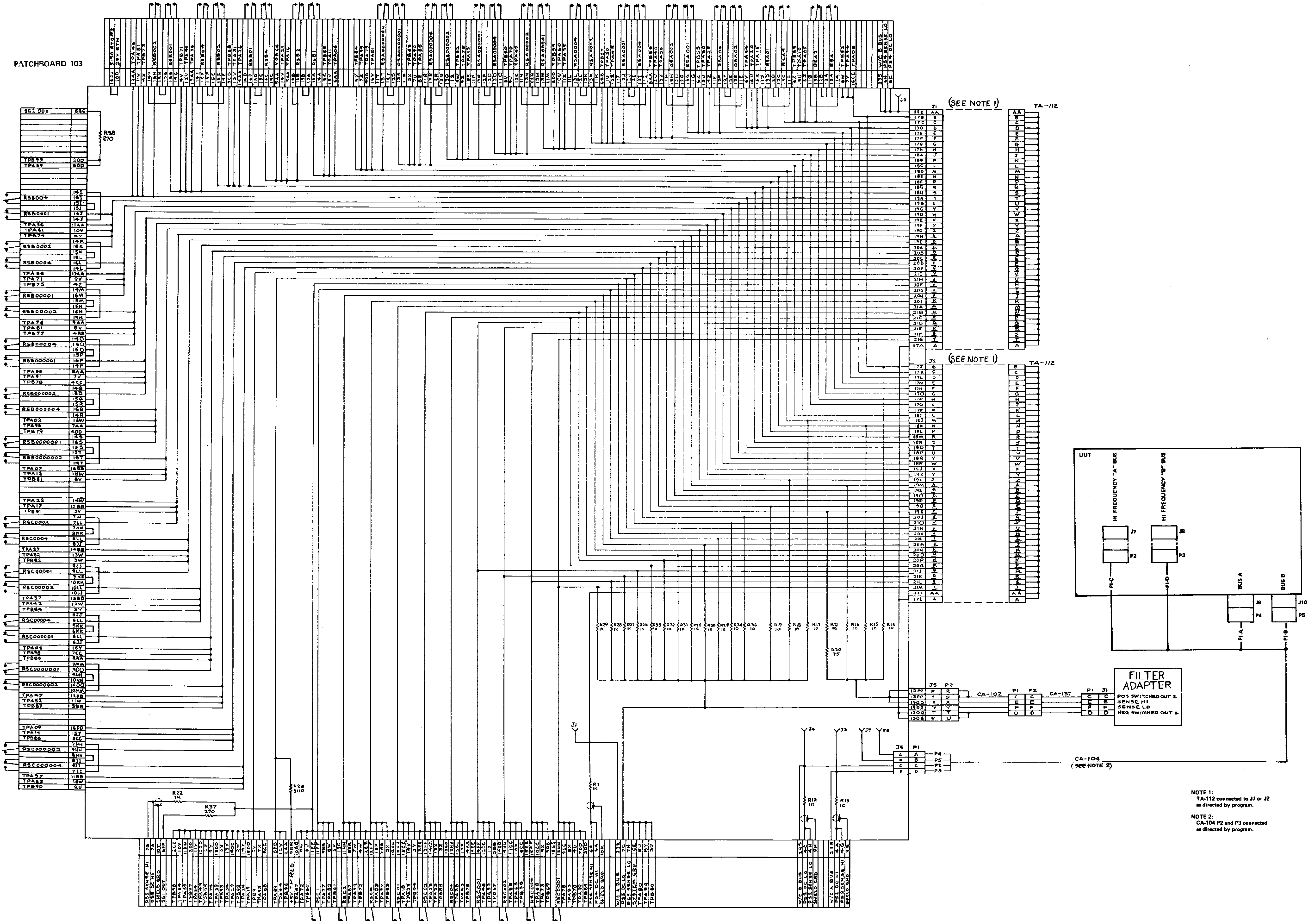

Figure 2-41. UUT 9720, test adapter interconnection diagram.

Section I. UTILIZING MULTILAYER TYPE PATCHBOARDS

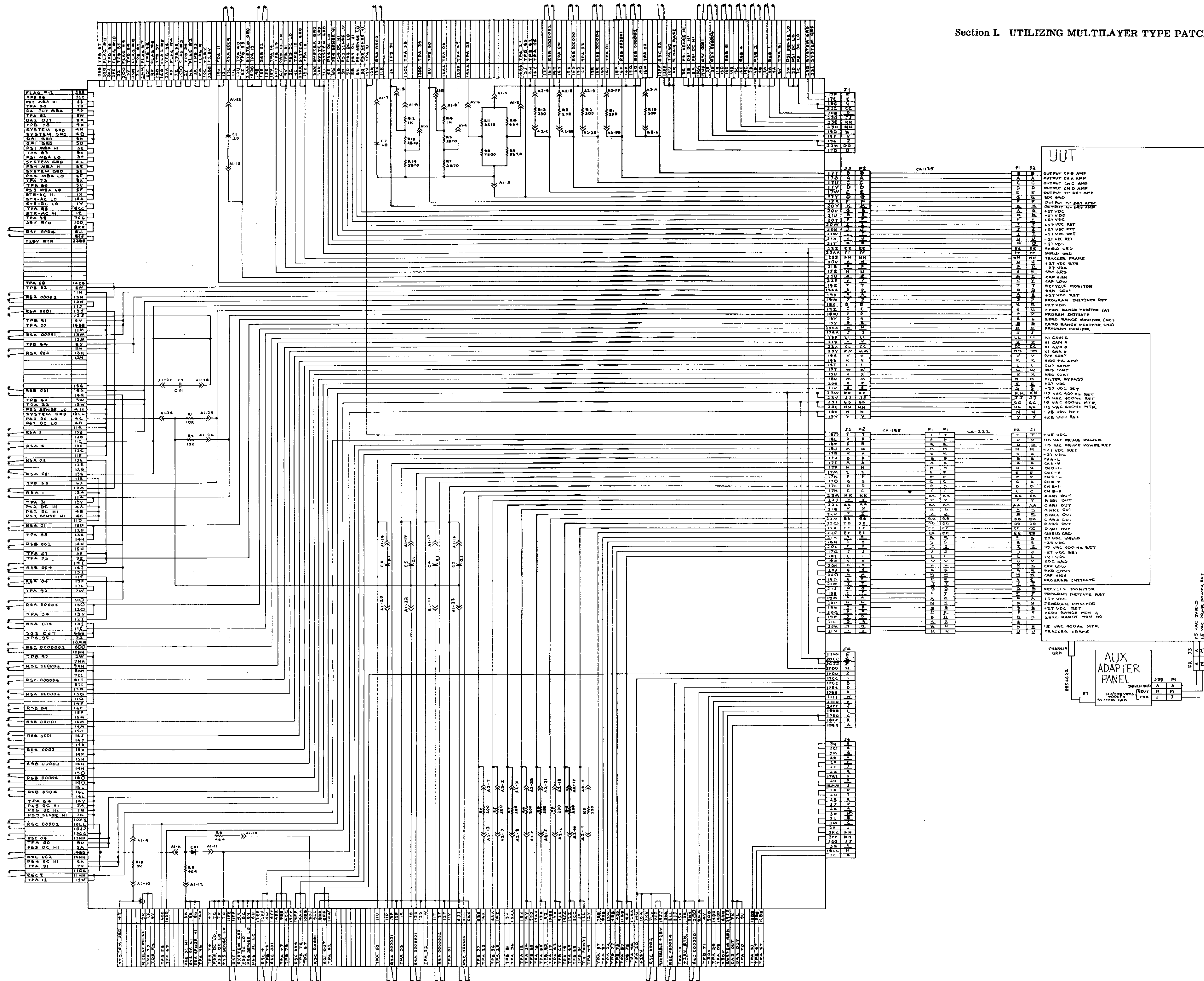

Figure 3-1. UUT 9510, Amplifier-Filter Adapter Interconnection Diagram.

Section II. UTILIZING SQUIB TYPE PATCHBOARDS

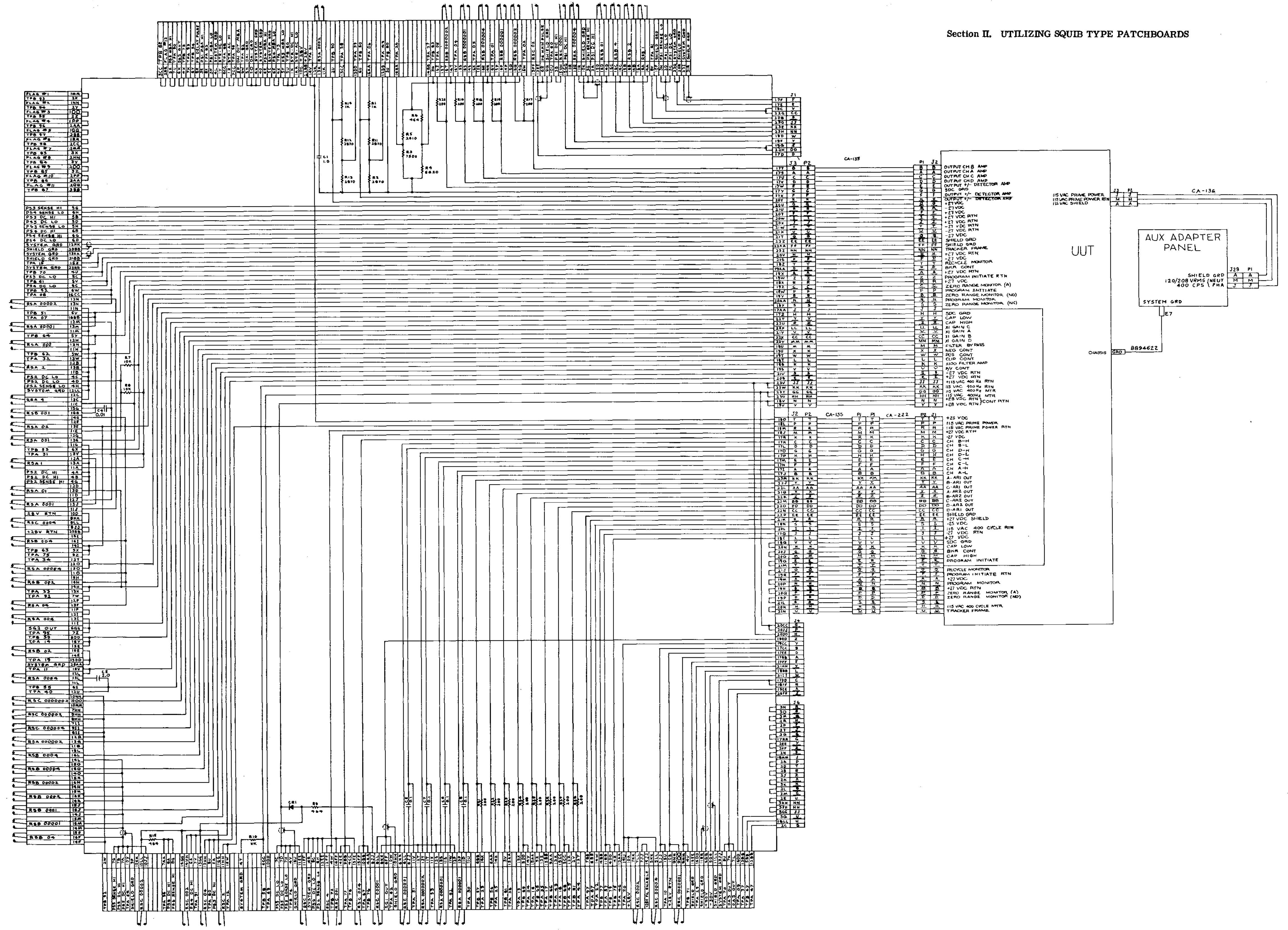

Figure 3-2. UUT 9510, Amplifier-Filter Adapter Interconnection Diagram.

SHILLELAGH INTERCONNECTION DIAGRAMS

Section I. UTILIZING MULTILAYER TYPE PATCHBOARDS

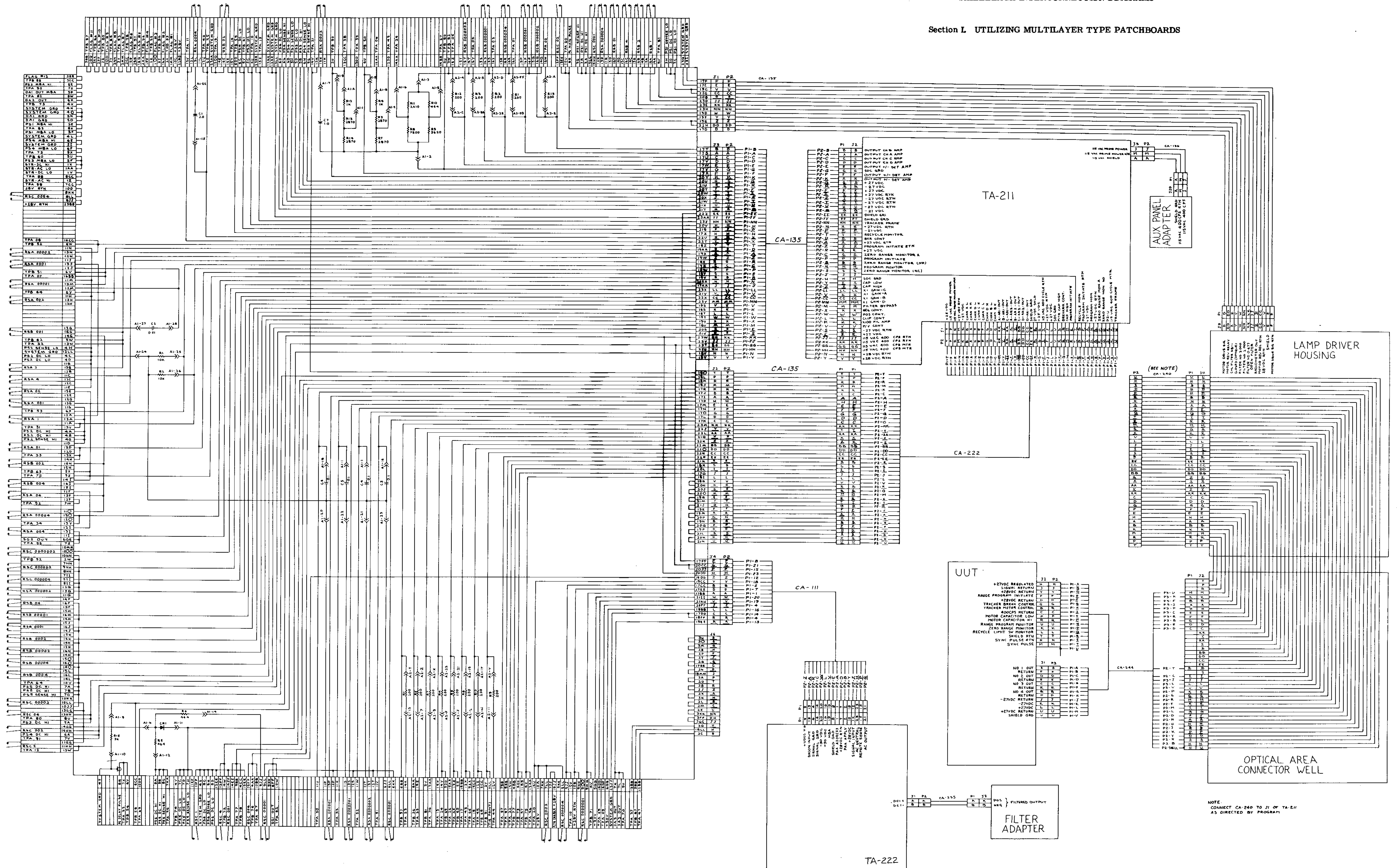

Figure 4-1. UUT 0100, Guided Missile Tracker Assembly (Static Hook-Up) Interconnection Diagram.



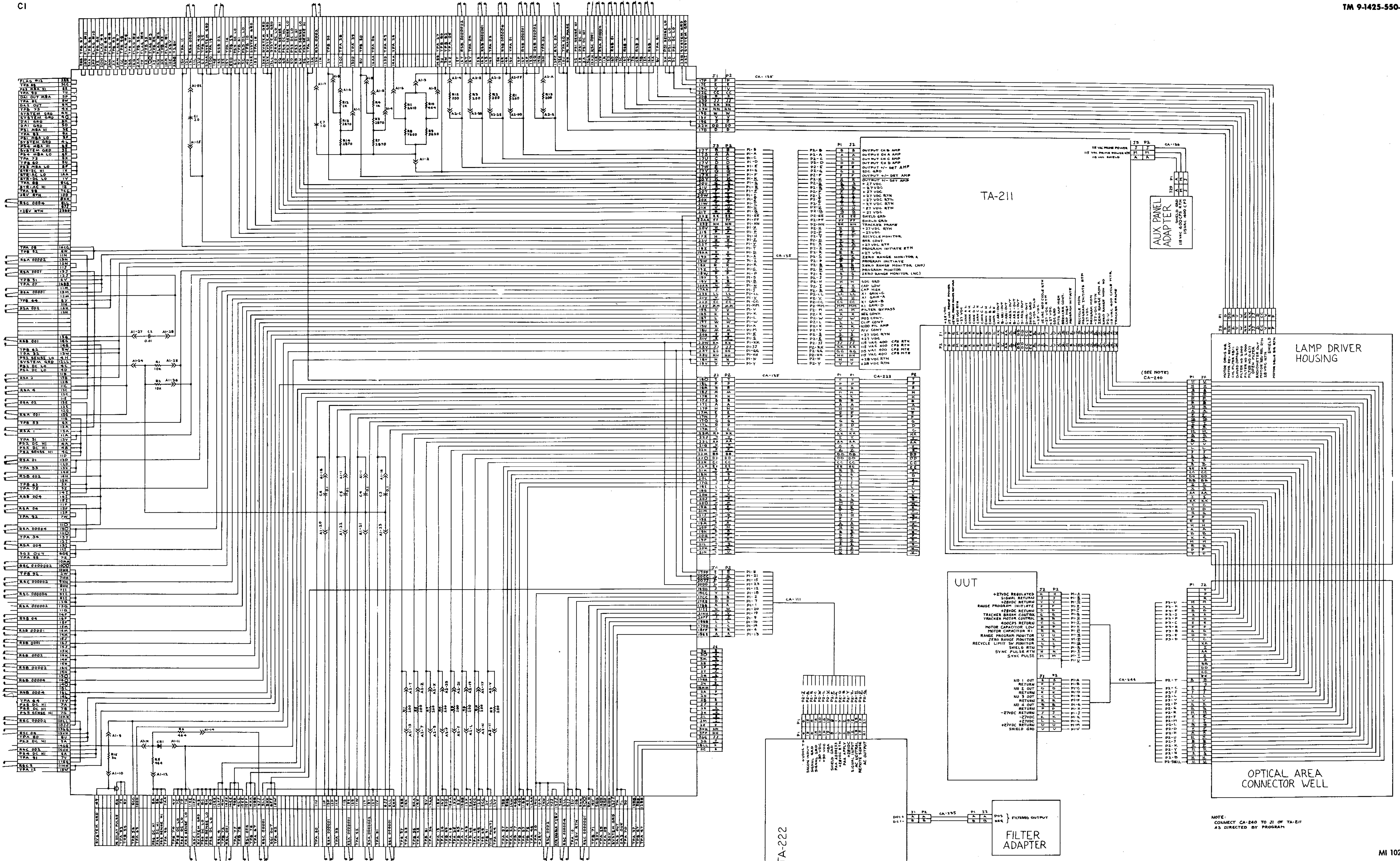

Figure 4-2. UUT 0100, Guided Missile Tracker Assembly (Go-Chain Cable Changes) Interconnection Diagram.

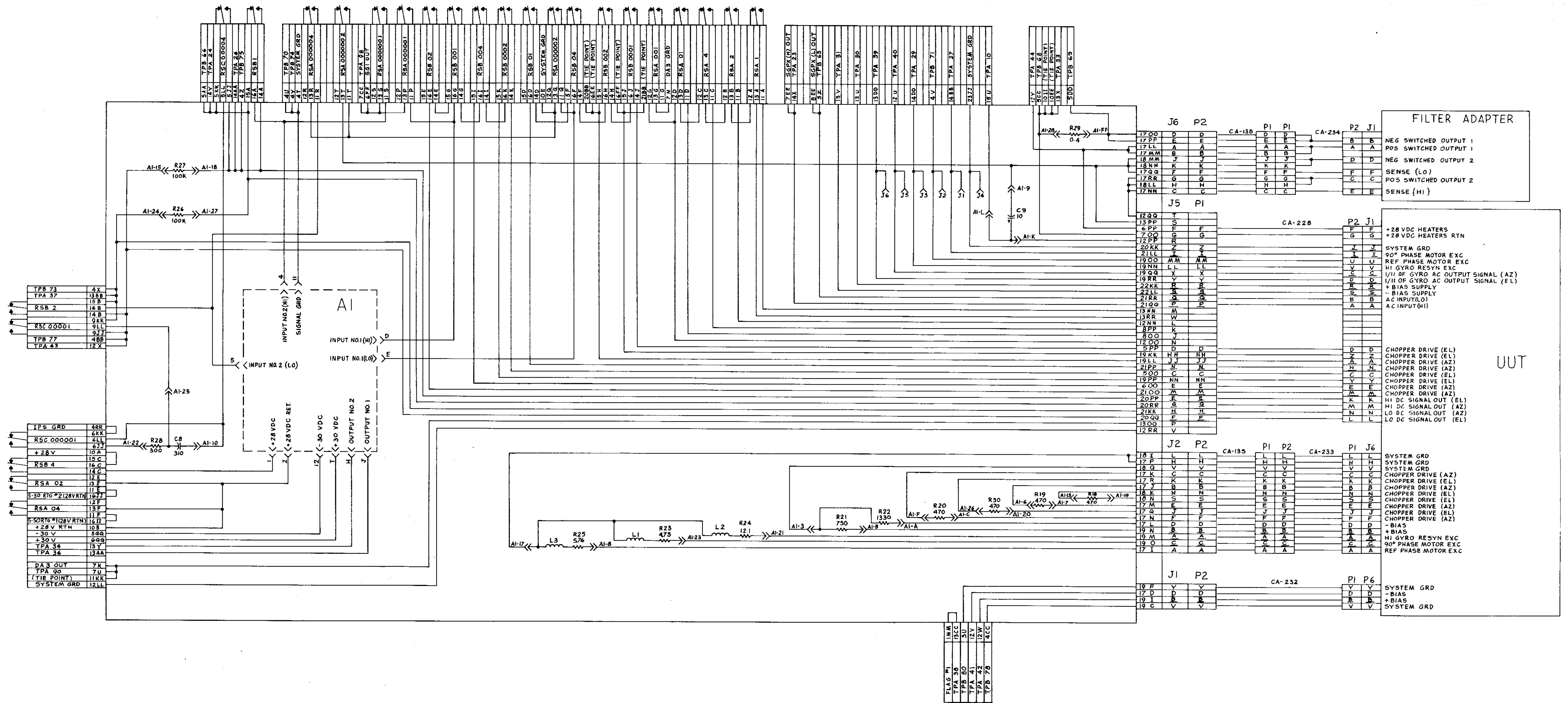

Figure 4-3. UUT 0200, Guided Missile Target Tracking, Rate Sensing Unit Interconnection Diagram.

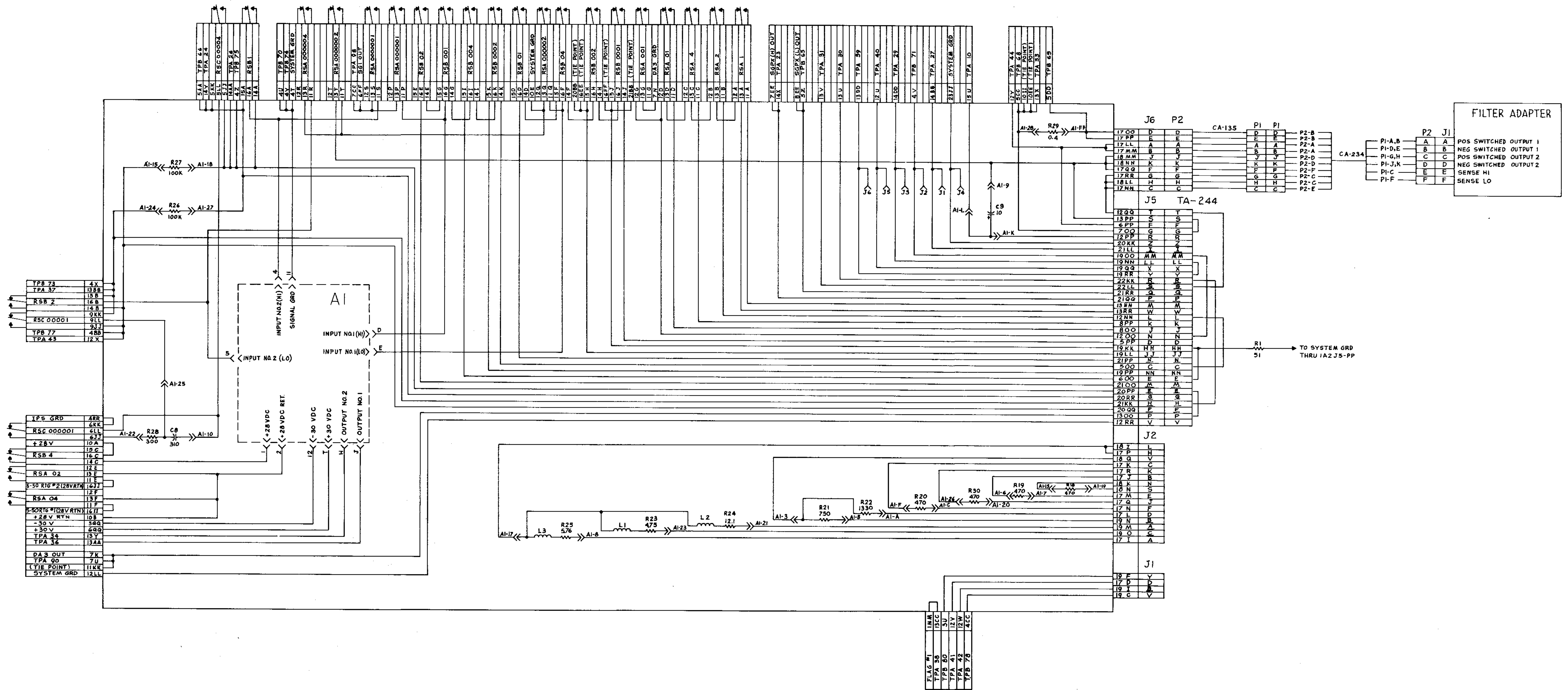

Figure 4-4. UUT 0200, Guided Missile Target Tracking, Rate Sensing Unit (Survey Hook-Up) Interconnection Diagram.

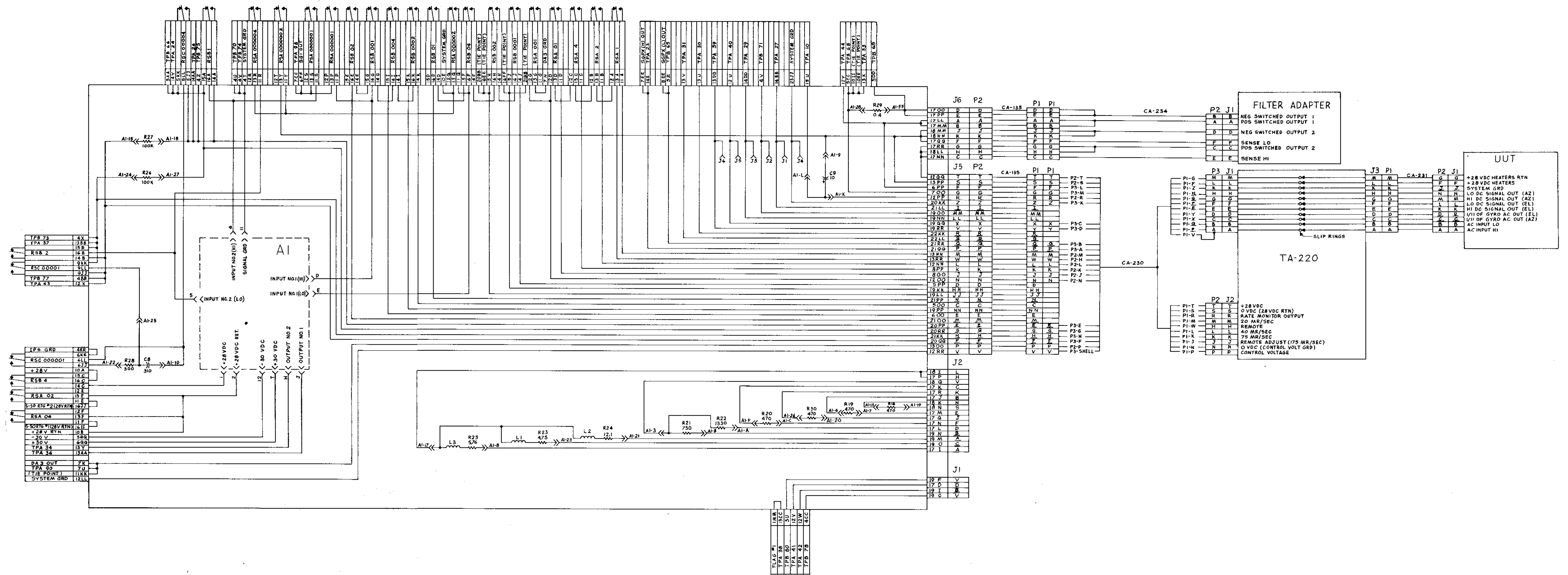

Figure 4-5. UUT 0200, Guided Missile Target Tracking, Rate Sensing Unit (Dynamic Hook-Up) Interconnection Diagram.

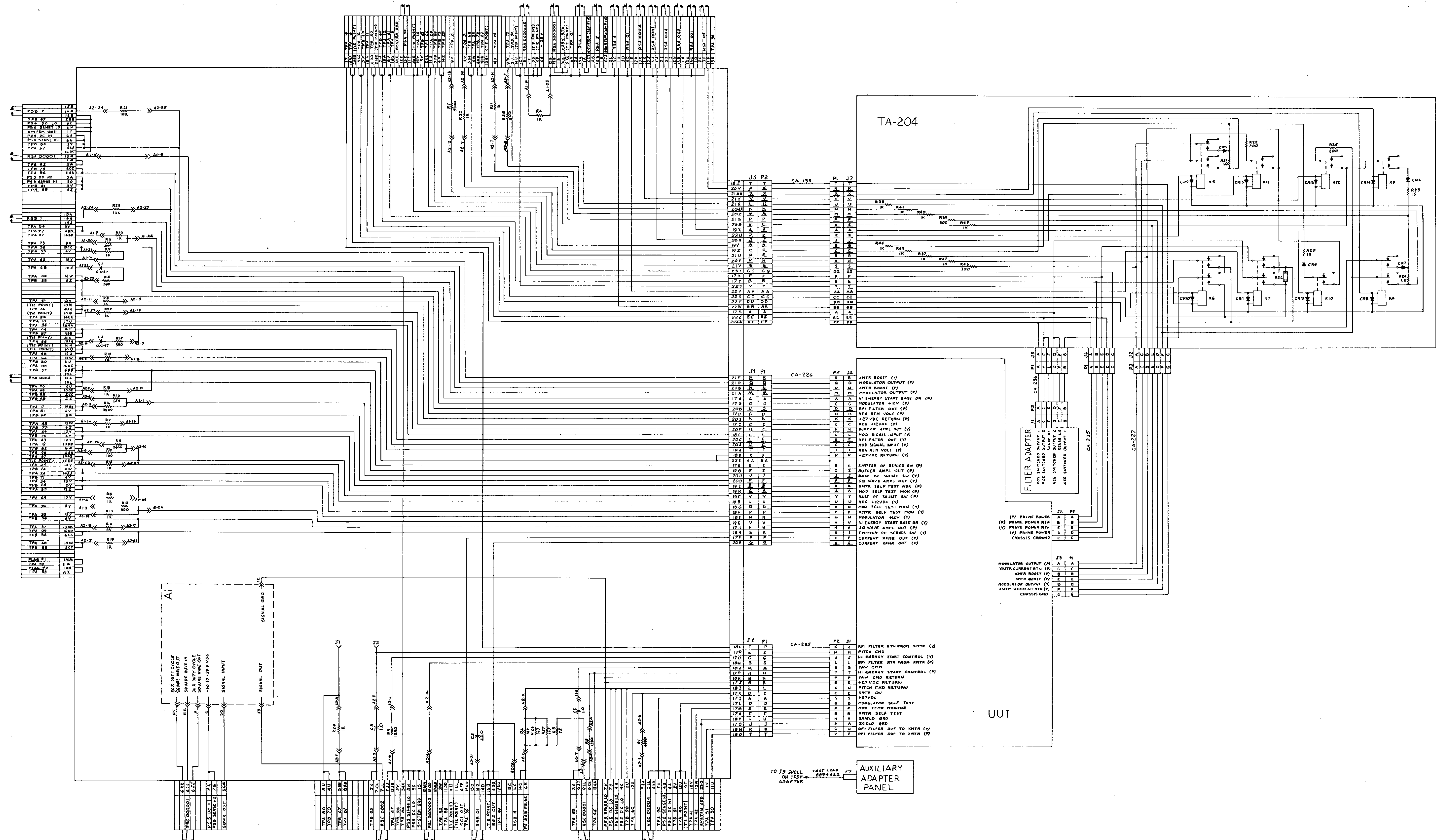

Figure 4-6. UUT 0500, Modulator Assembly Interconnection Diagram.

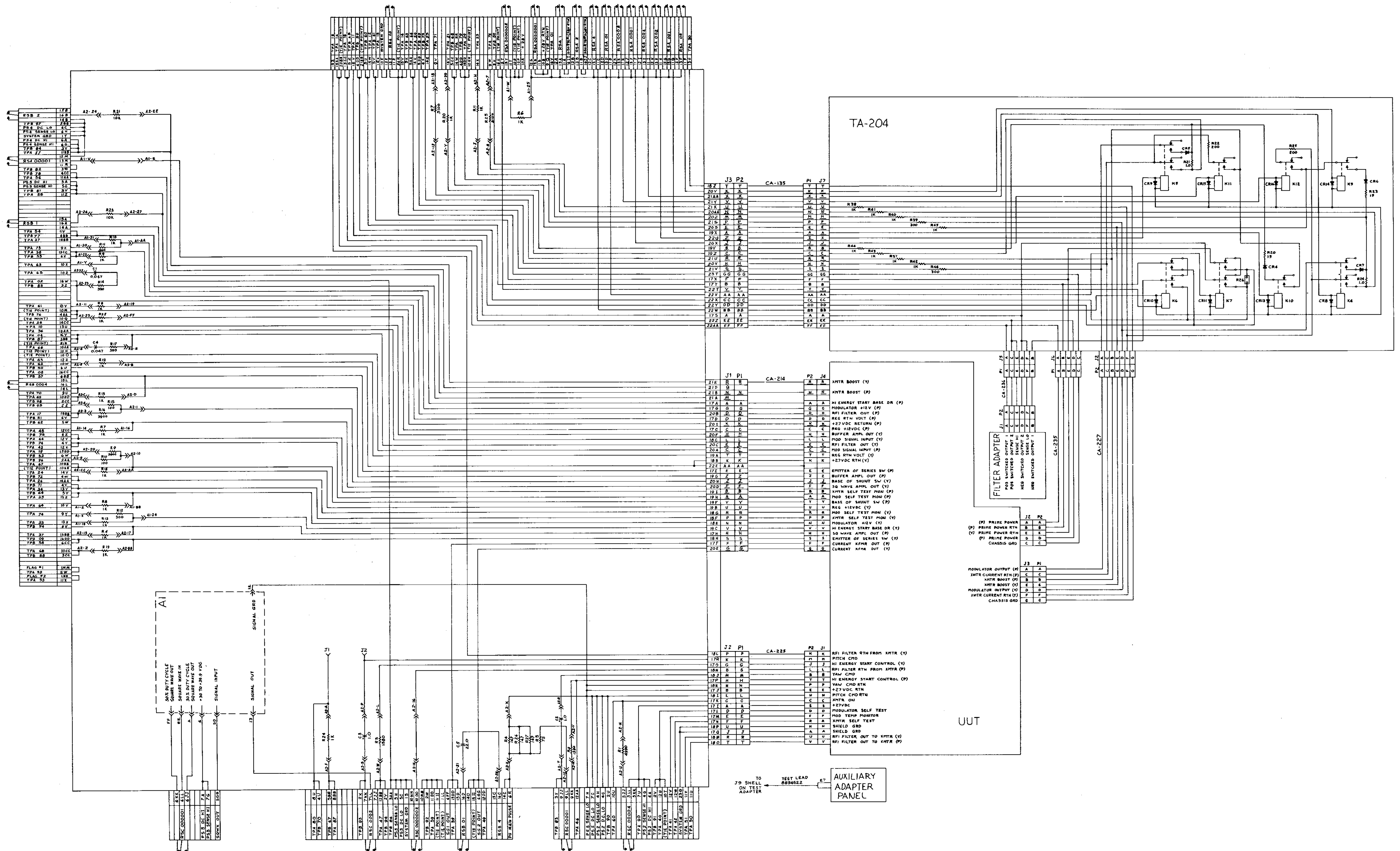

Figure 4-7. UUT 0500, Modulator Assembly (Go-Chain Cable Changes) Interconnection Diagram.

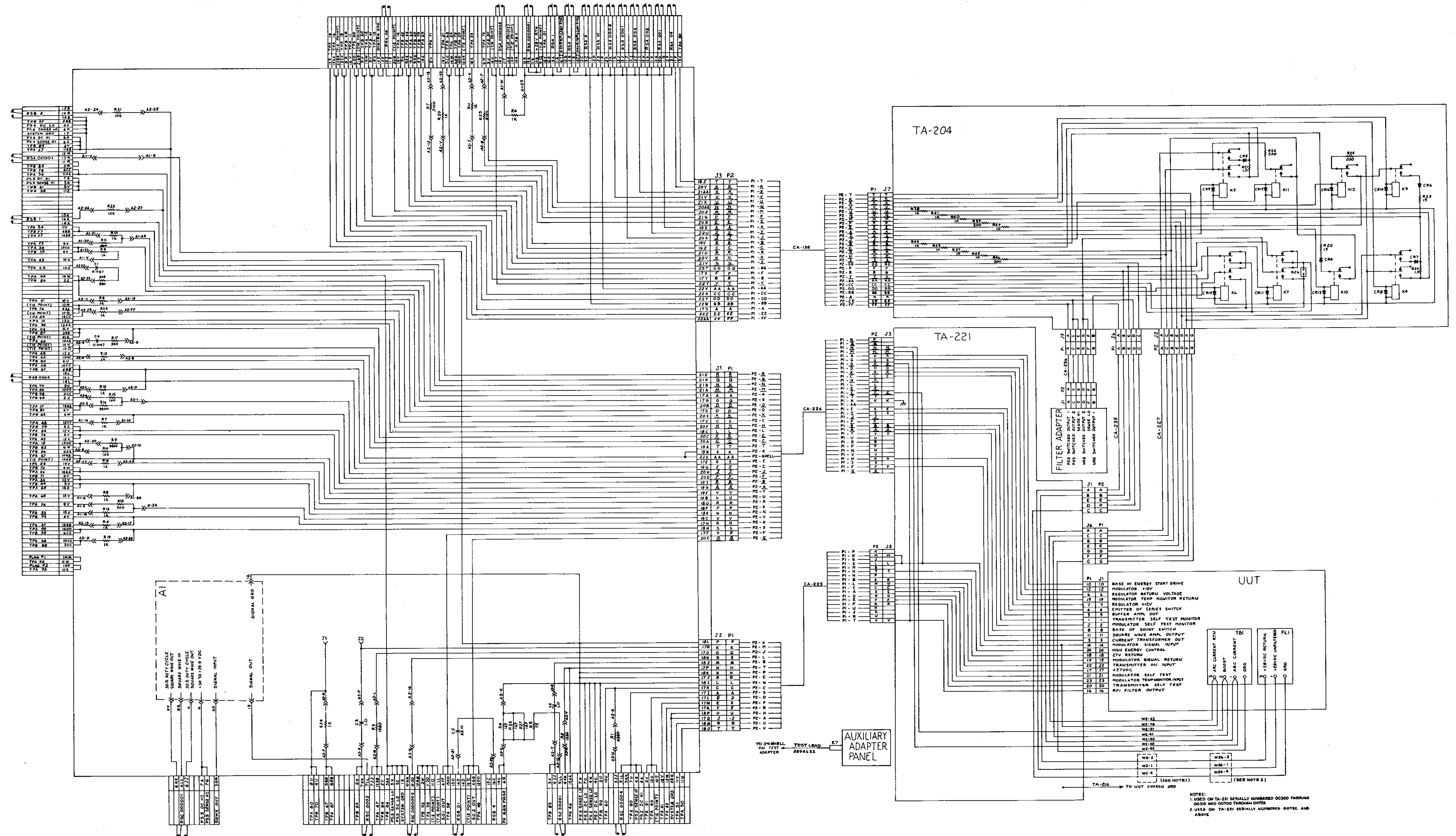

Figure 4-8. UUT 0510, Modulator Subassembly Interconnect Diagram.

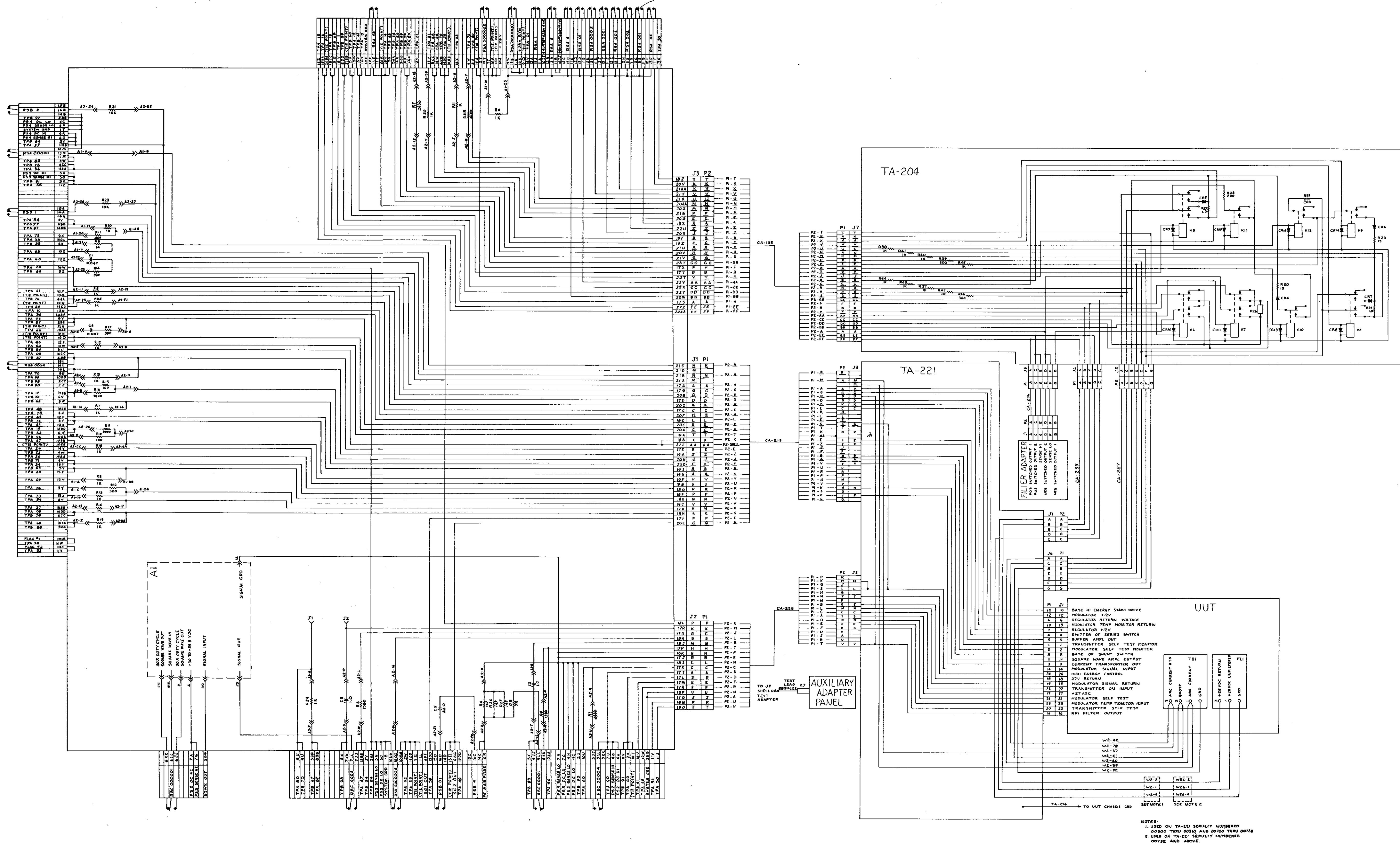

Figure 4-9. UUT 0510, Modulator Subassembly (Test Fixture Configuration Variation) Interconnection Diagram.



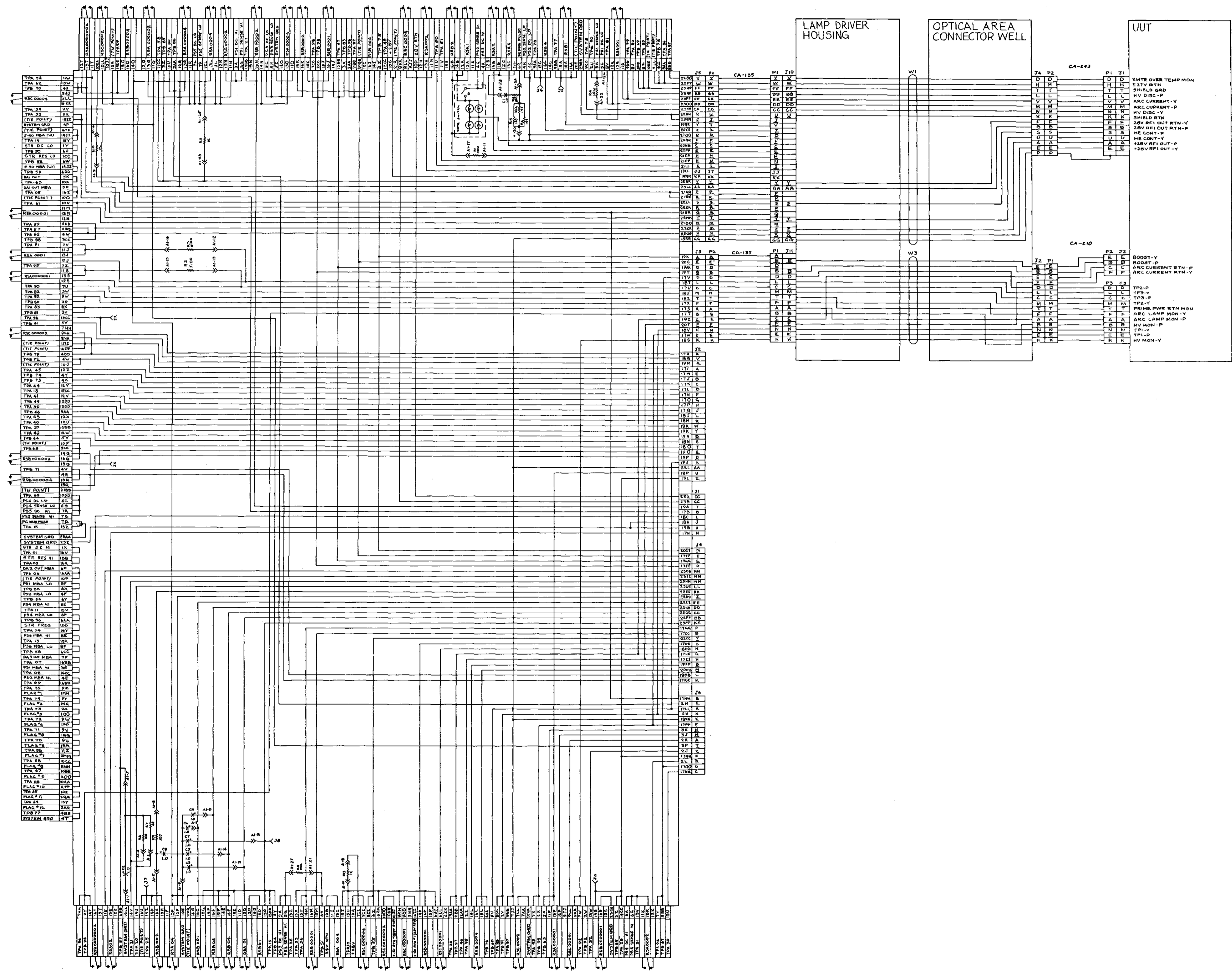

Figure 4-10. UUT 0600 Transmitter Assembly Interconnection Diagram.

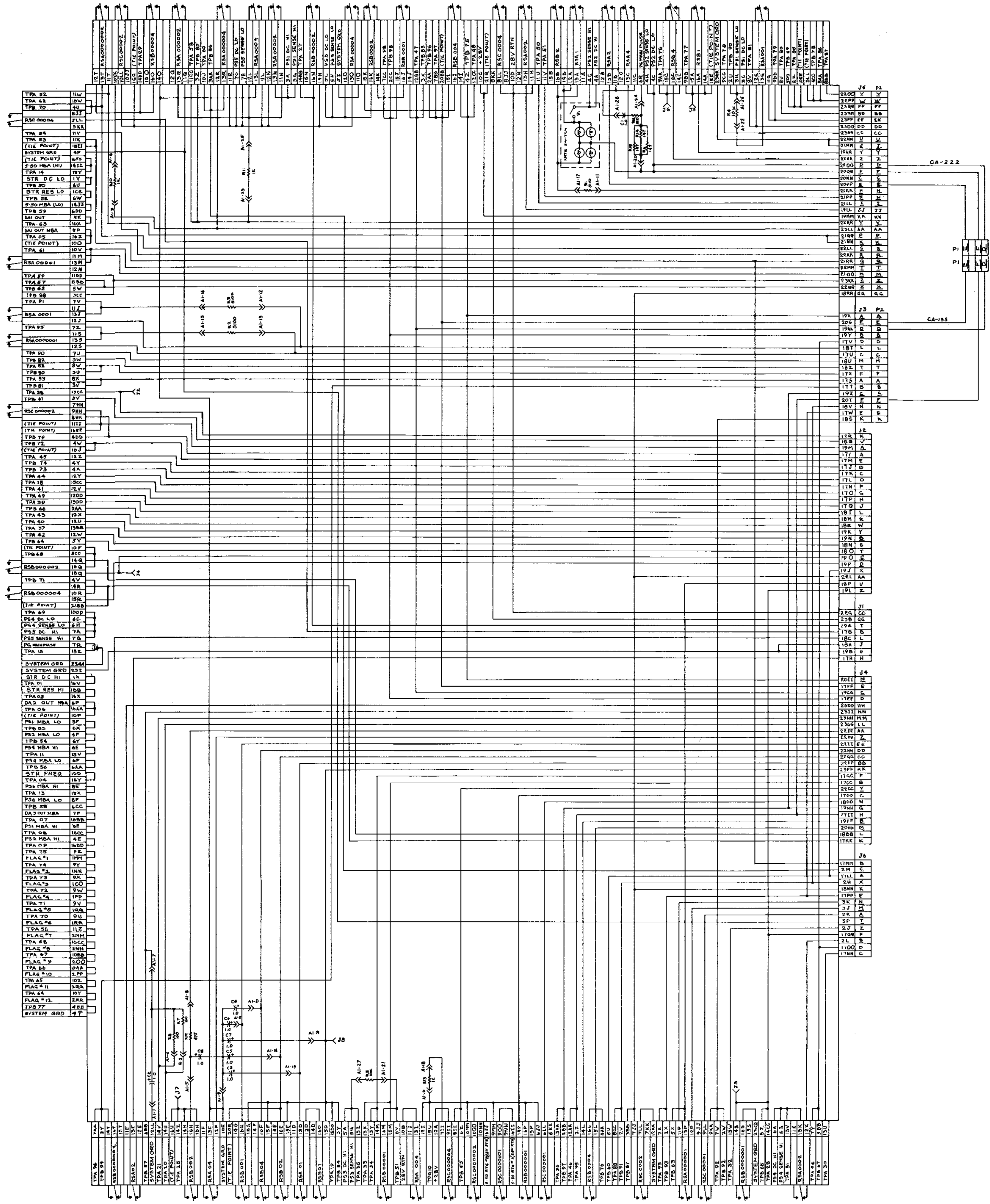

Figure 4-11. UUT 0600, Transmitter Assembly (Survey Hook-Up) Interconnection Diagram.

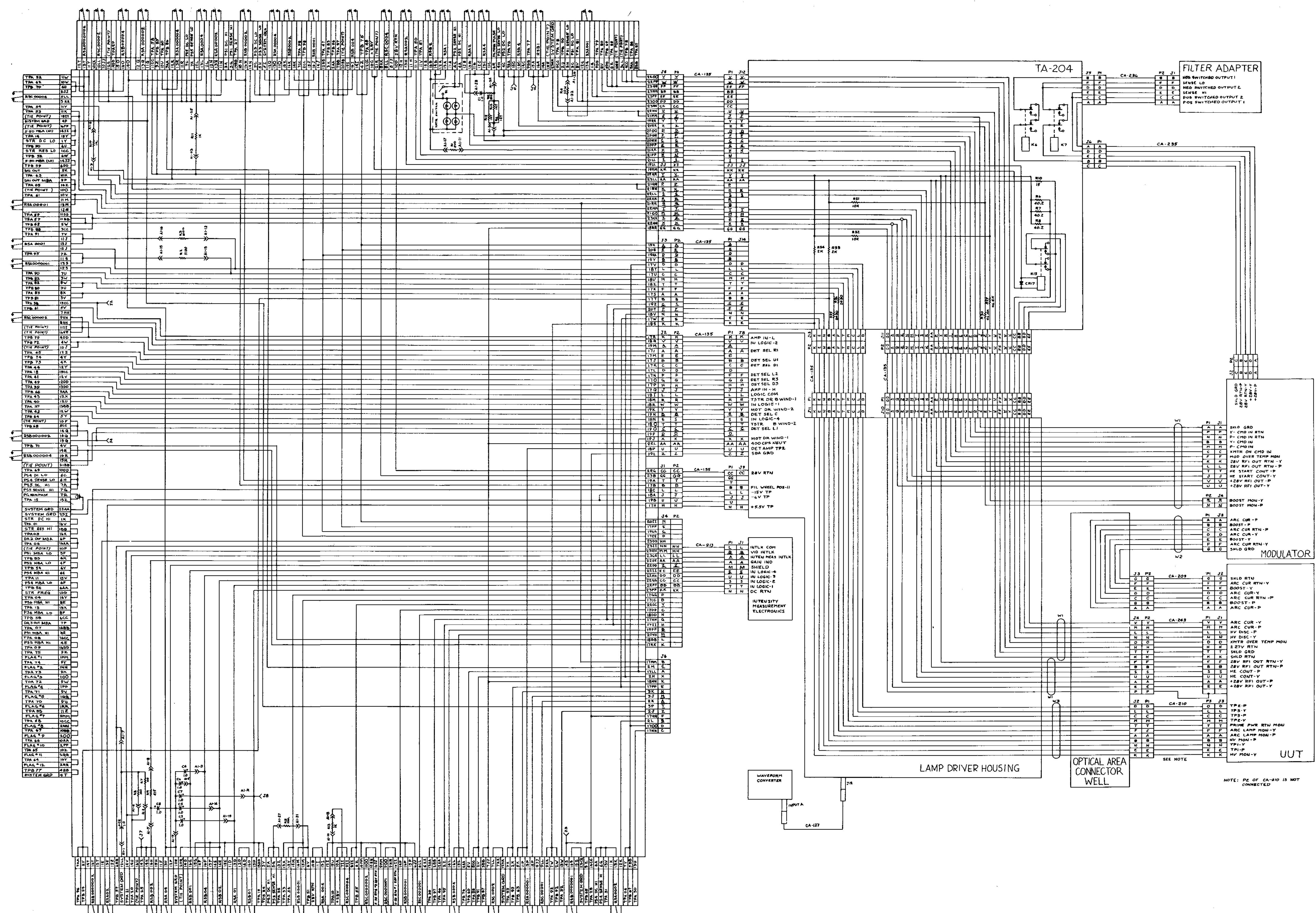

Figure 4-10 UUT A600 Transmitter Assembly (Dynamic Hook-In)

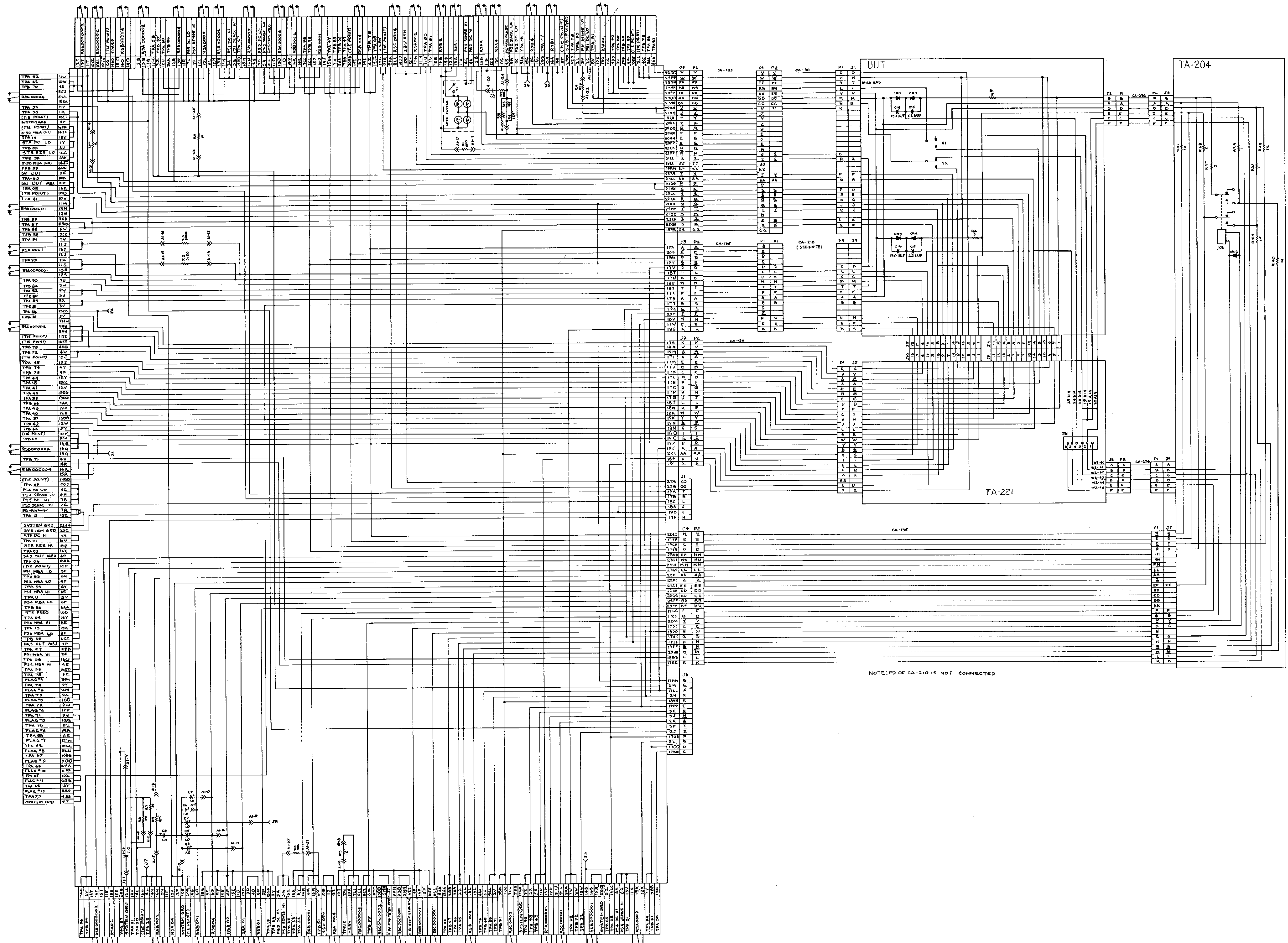

Figure 4-13. UUT 0610, Transmitter Filter Panel Assembly Interconnection Diagram.

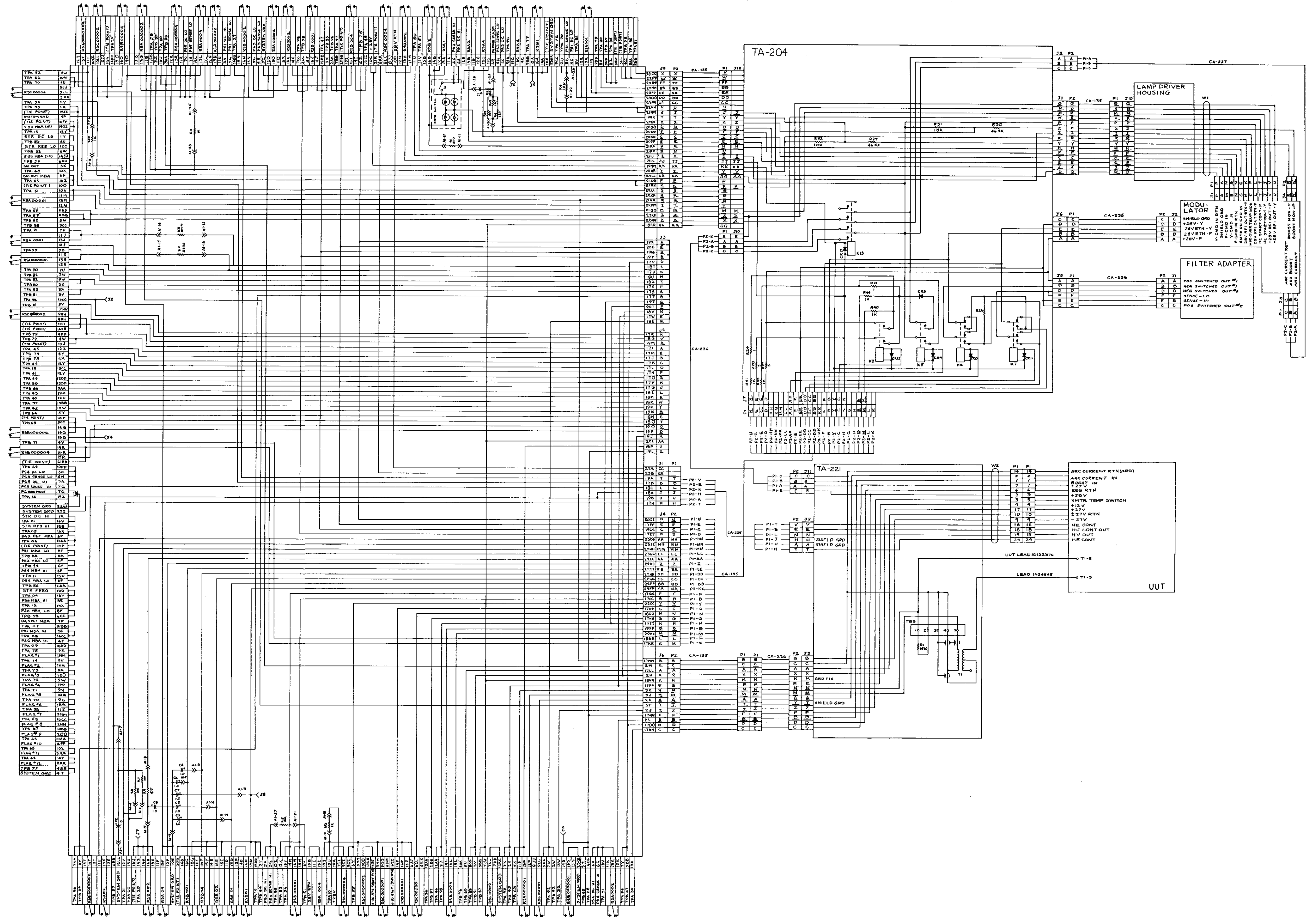

Figure 4-14. UUT 0820, Transmitter Starter Electronics Assembly Interconnection Diagram.

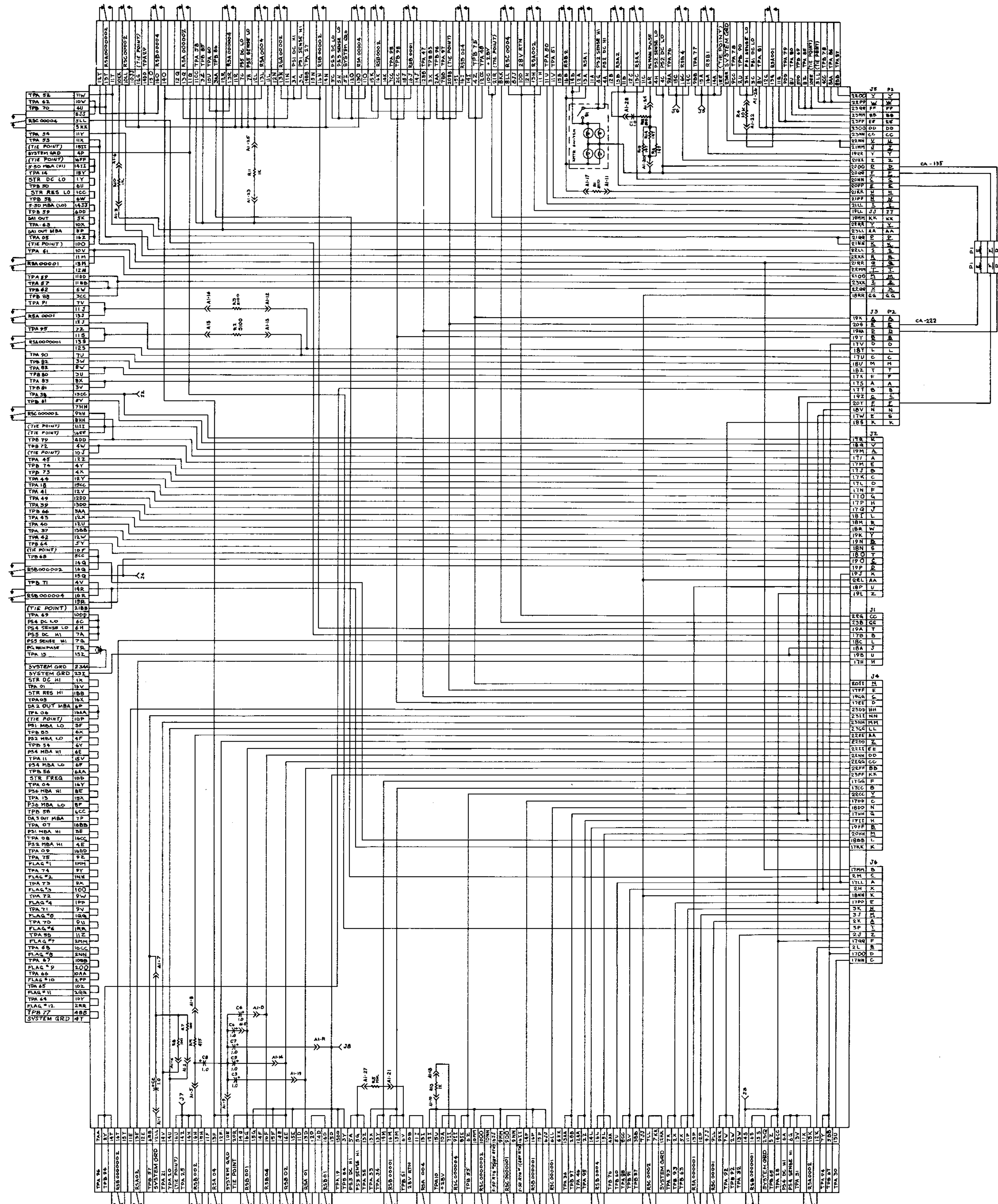

Figure 4-15. UUT 0620, Transmitter Starter Electronics Assembly (Survey Hook-Up) Interconnection Diagram.

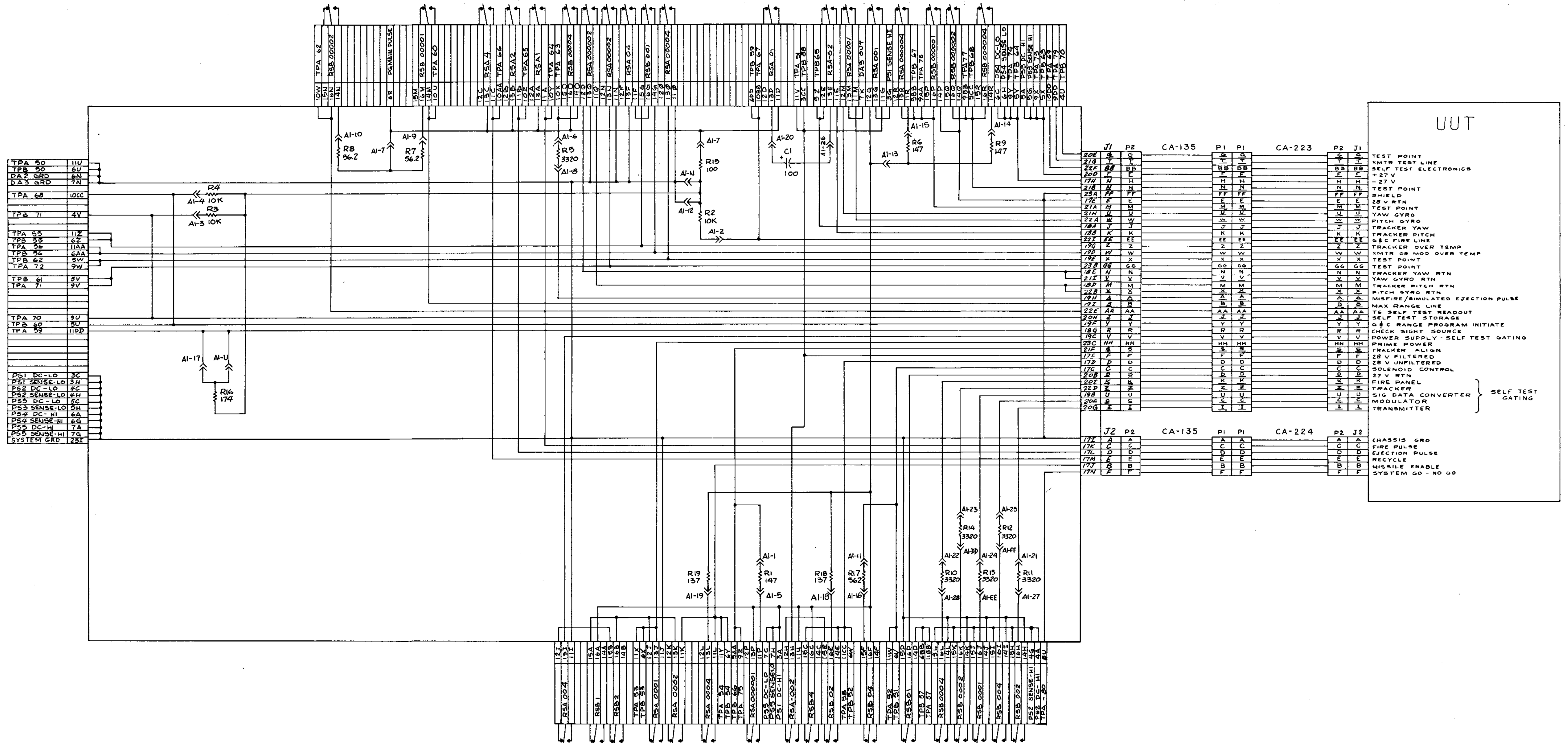

Figure 4-16. UUT 0700, Test Checkout Panel Assembly Interconnection Diagram.



Figure 4-17. UUT 0700, Test Checkout Panel Assembly (Survey Hook-Up) Interconnection Diagram.



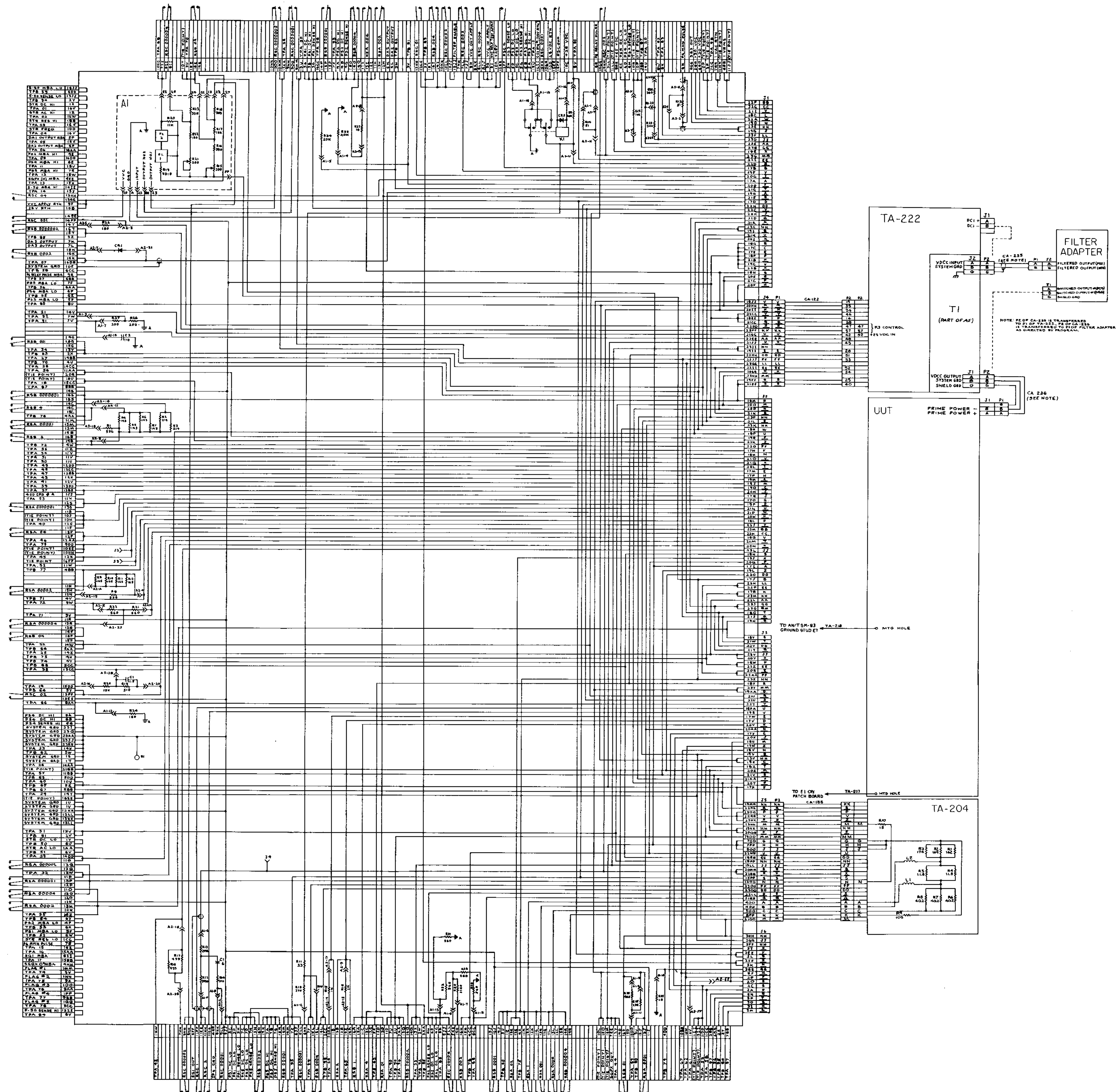

Figure 4-18. UUT 0800, Power Supply Assembly Interconnection Diagram.

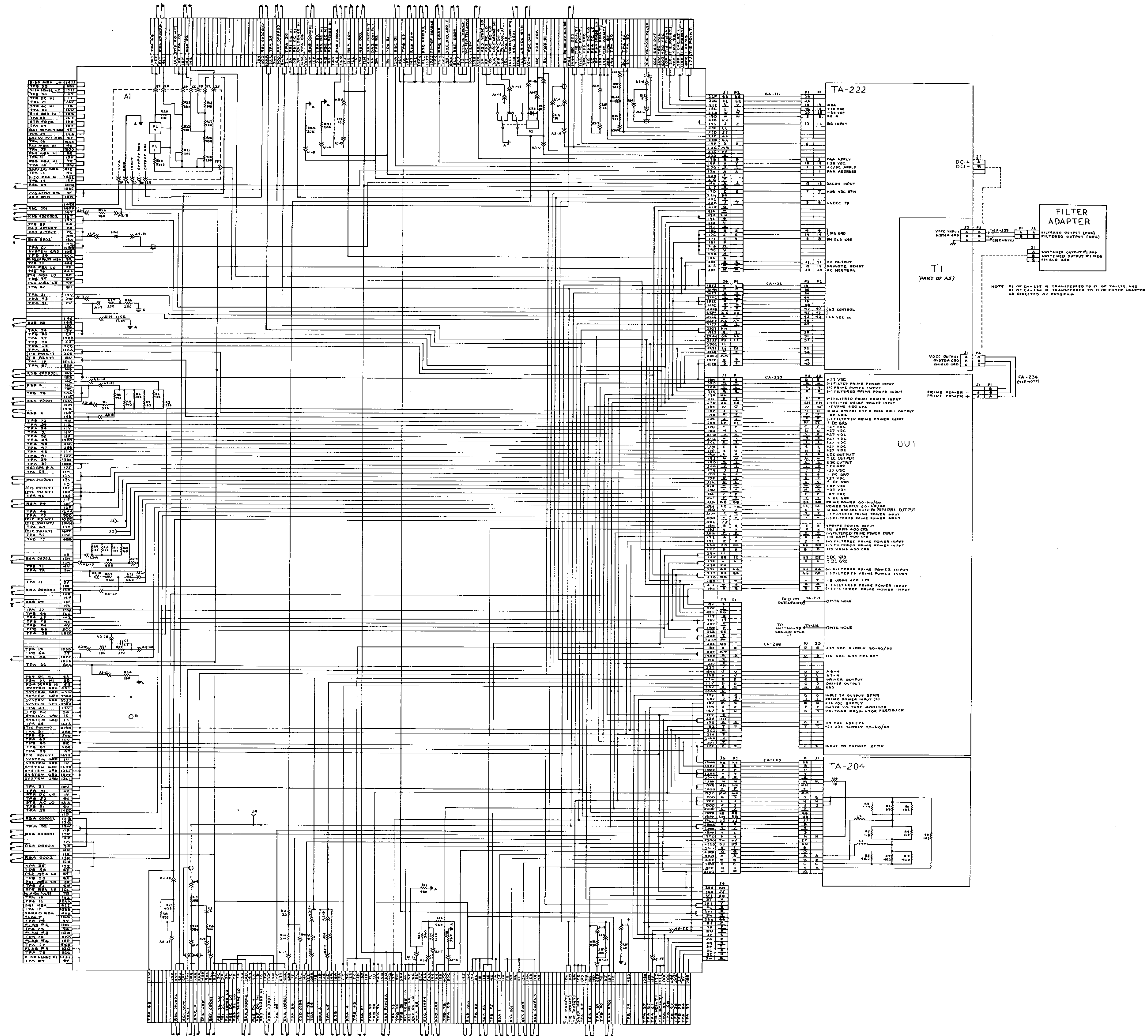

Figure 4-19. UUT 0800, Power Supply Assembly (Go-Chain Cable Changes) Interconnection Diagram

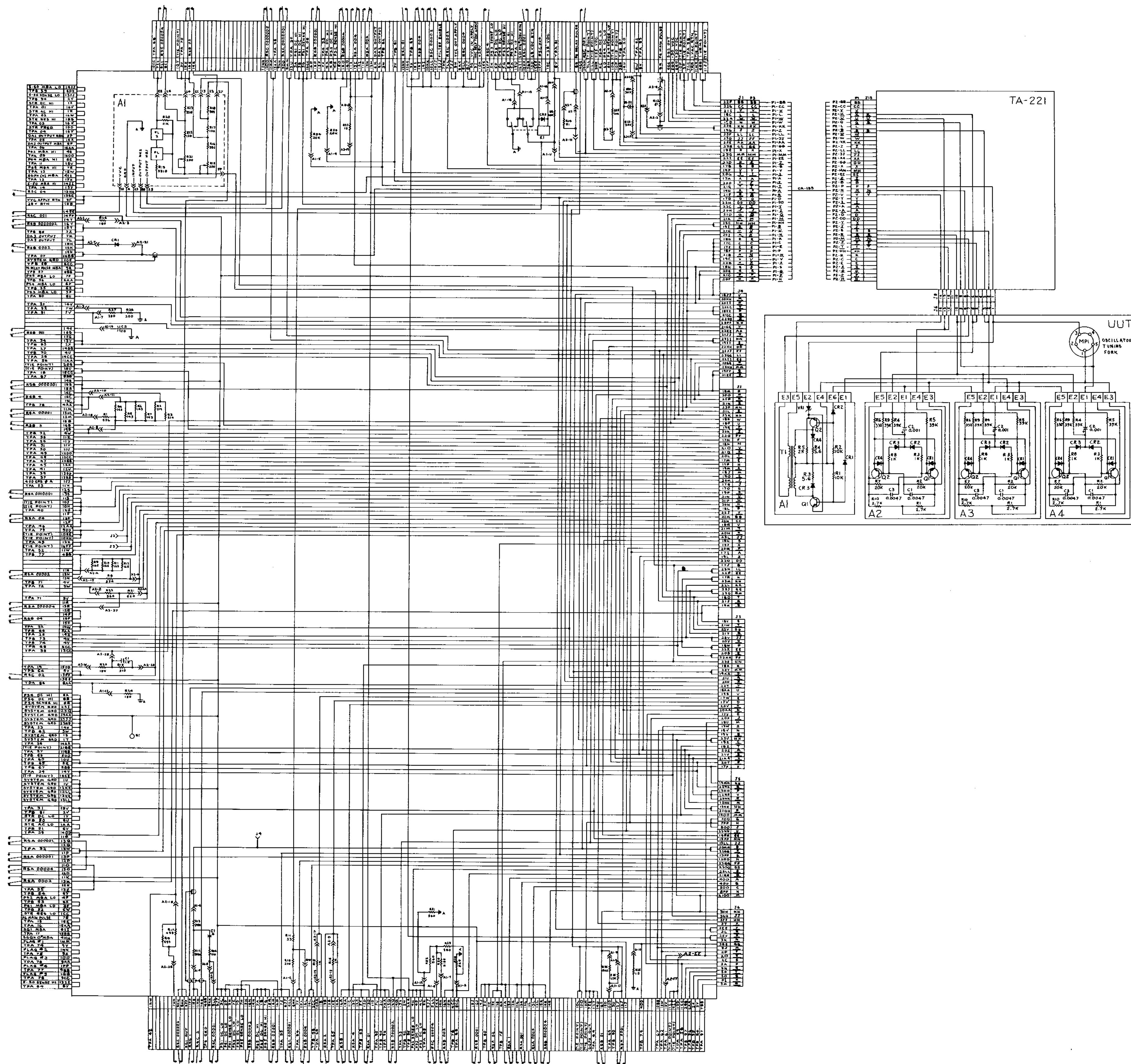

Figure 4-20. UUT 0830, Count Down Module Interconnection Diagram.

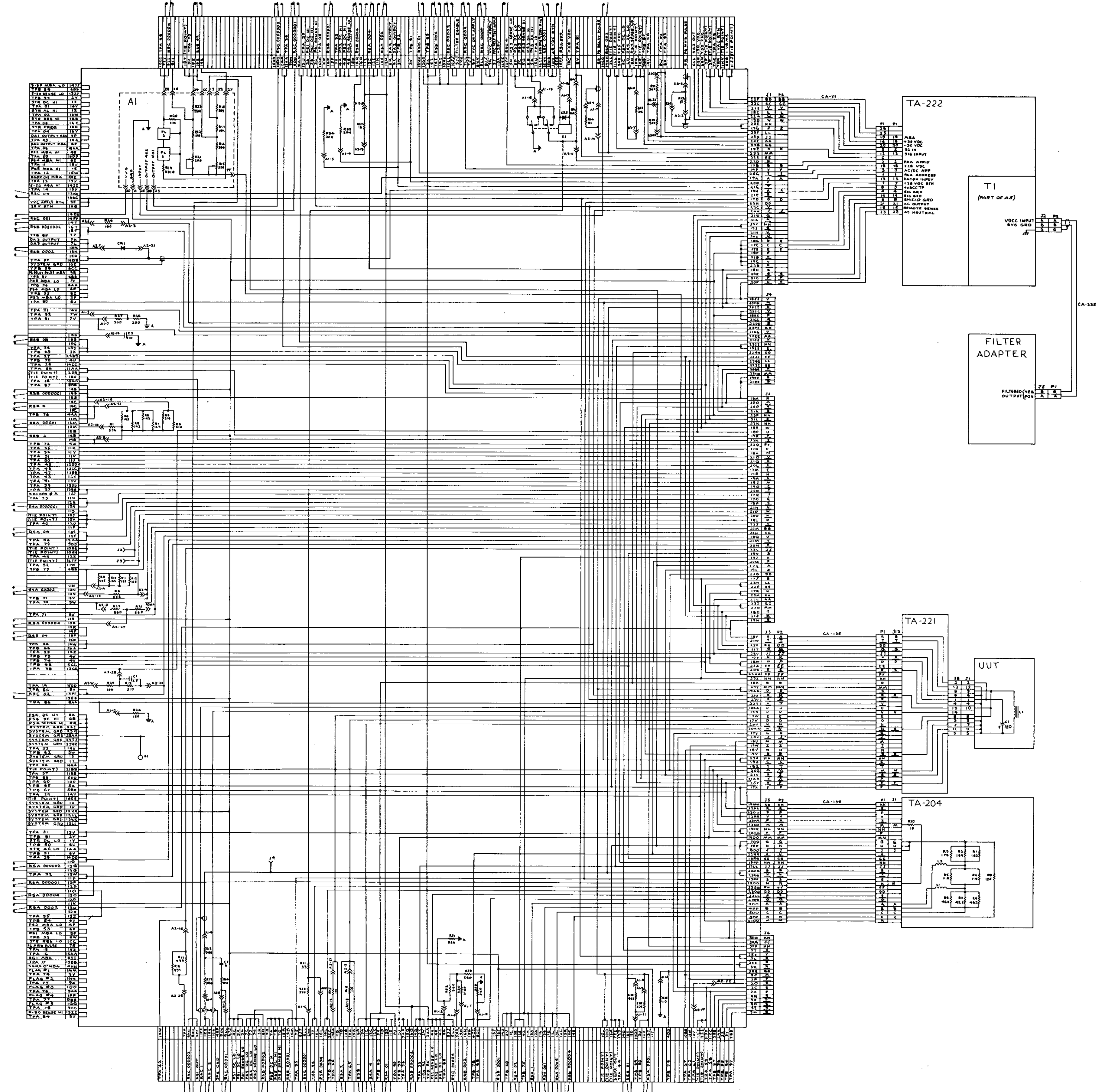

Figure 4-21. UUT 0880, Prime Power Filter Module Interconnection Diagram.

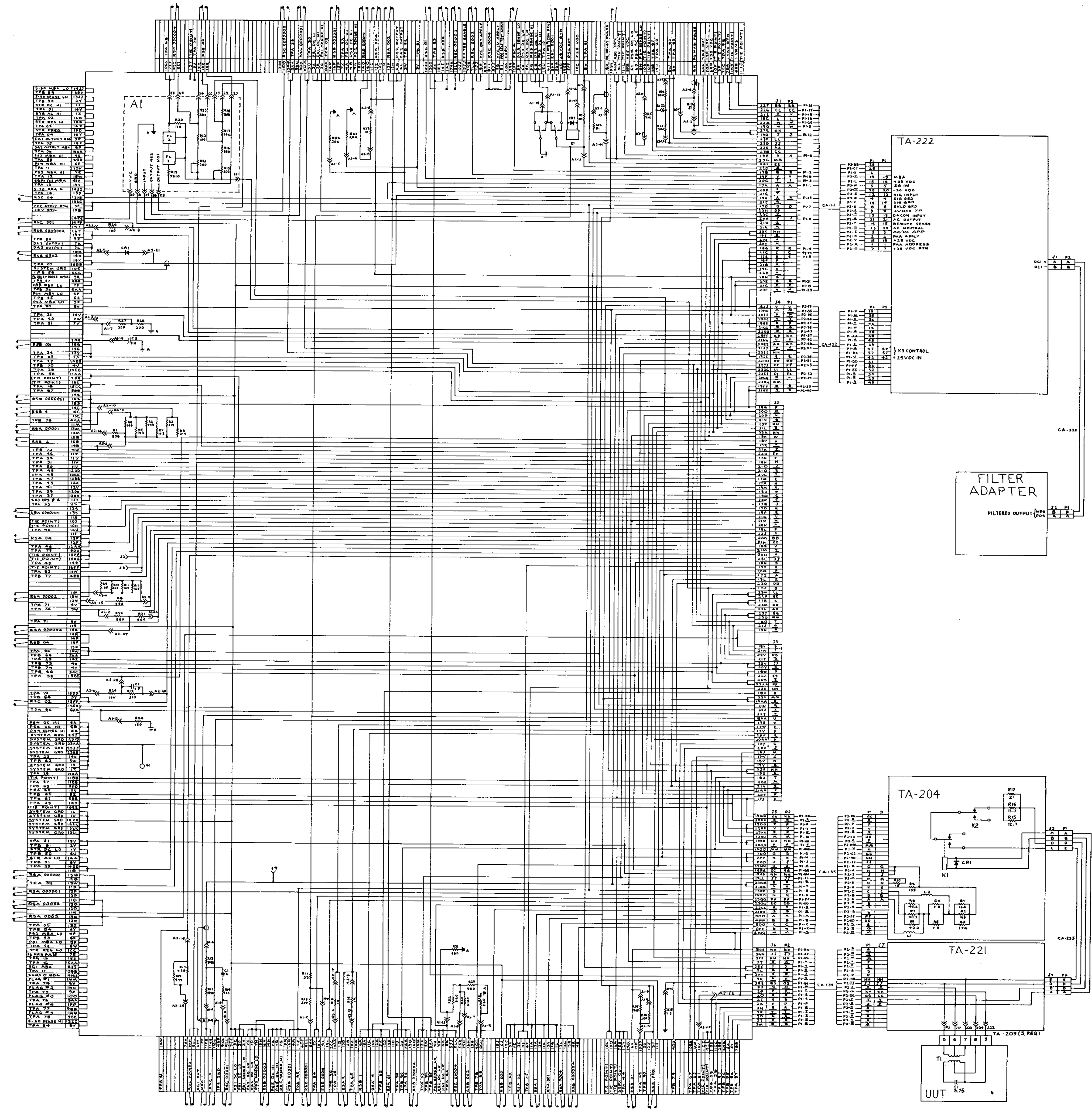

Figure 4-22. UUT 0890, Output Transformer Module Interconnection Diagram.

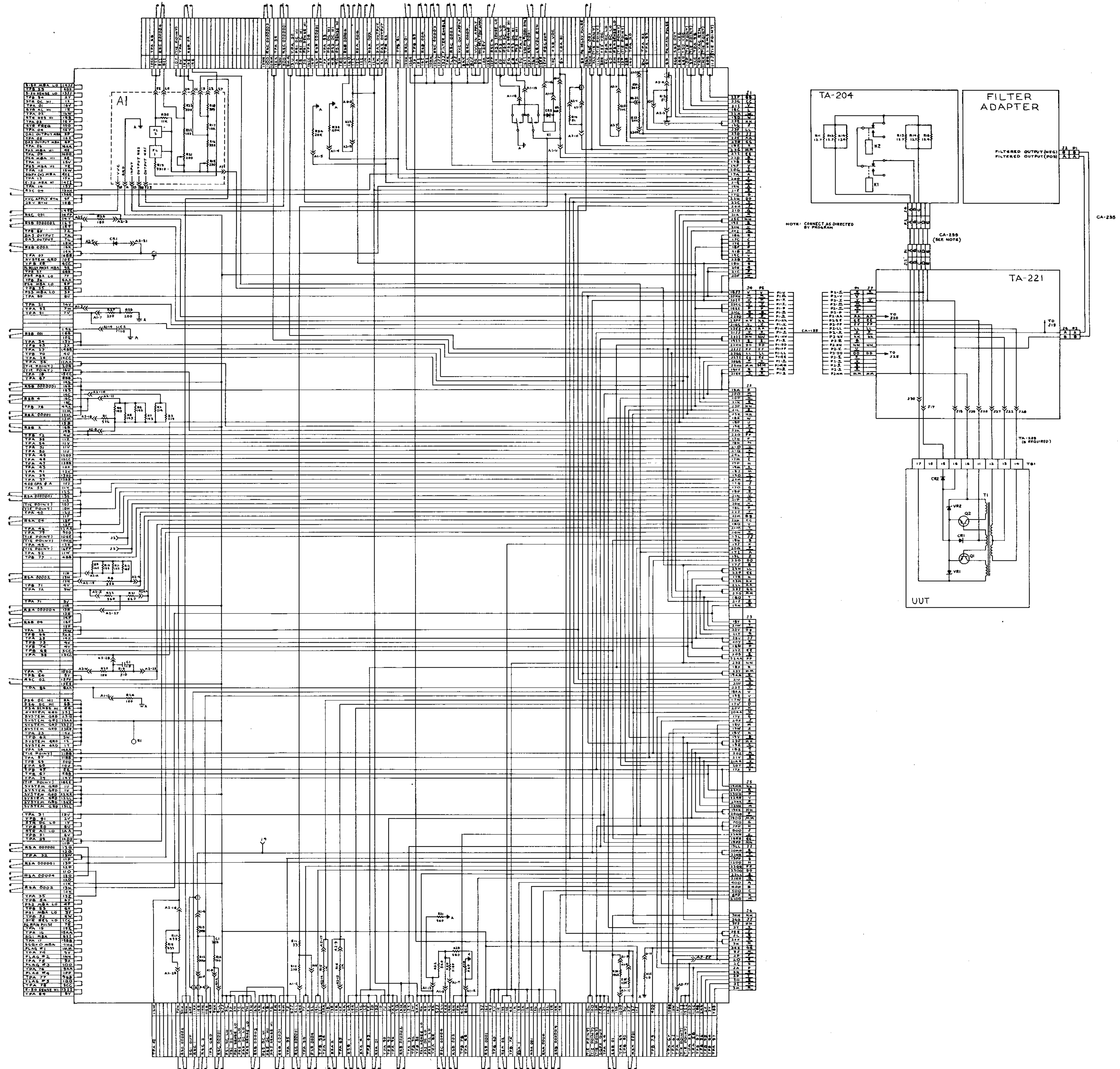

Figure 4-23. UUT 0920, Power Transistor Module Interconnection Diagram.

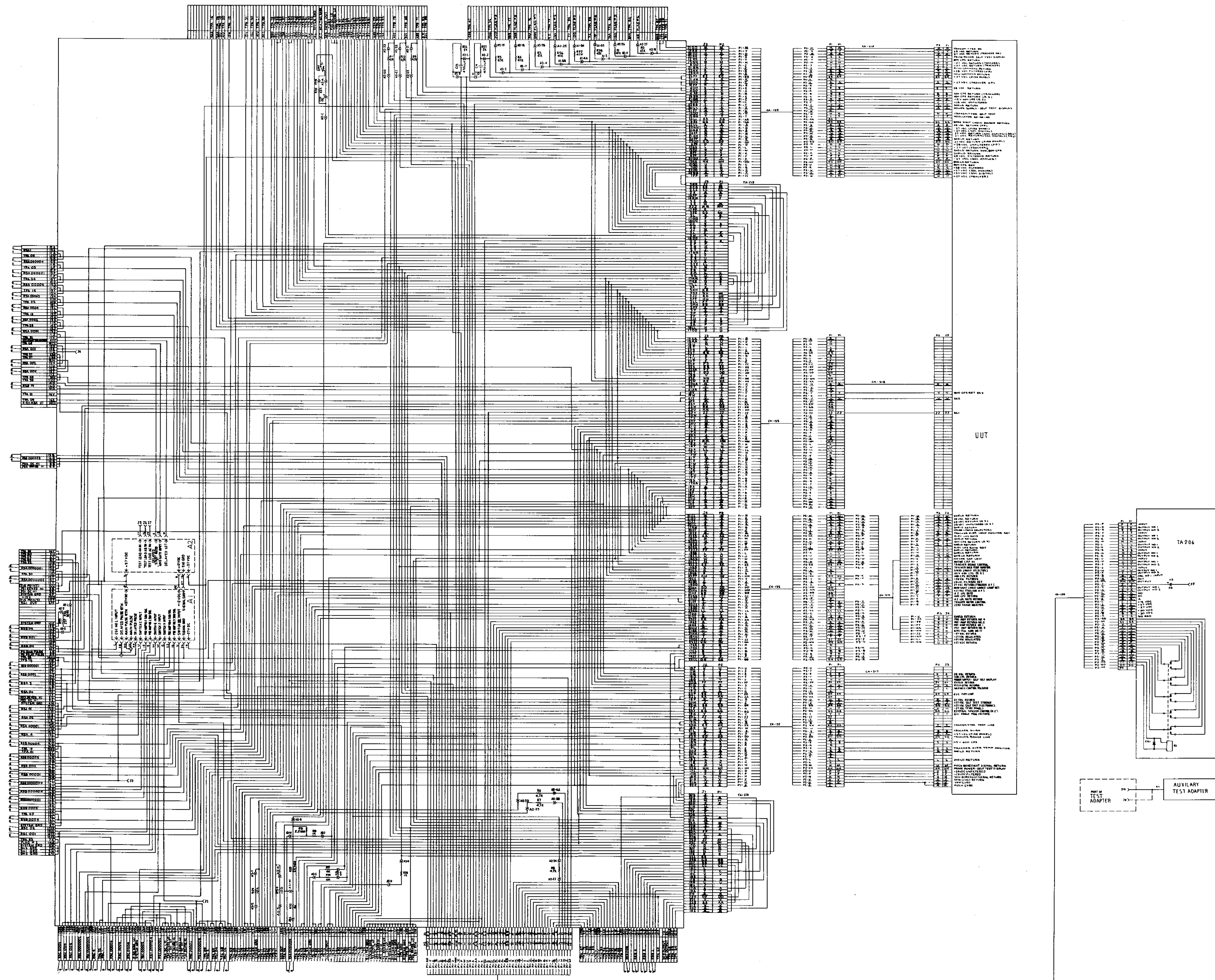

Figure 4-24. UUT 1500, Signal Data Converter Assembly Interconnection Diagram.

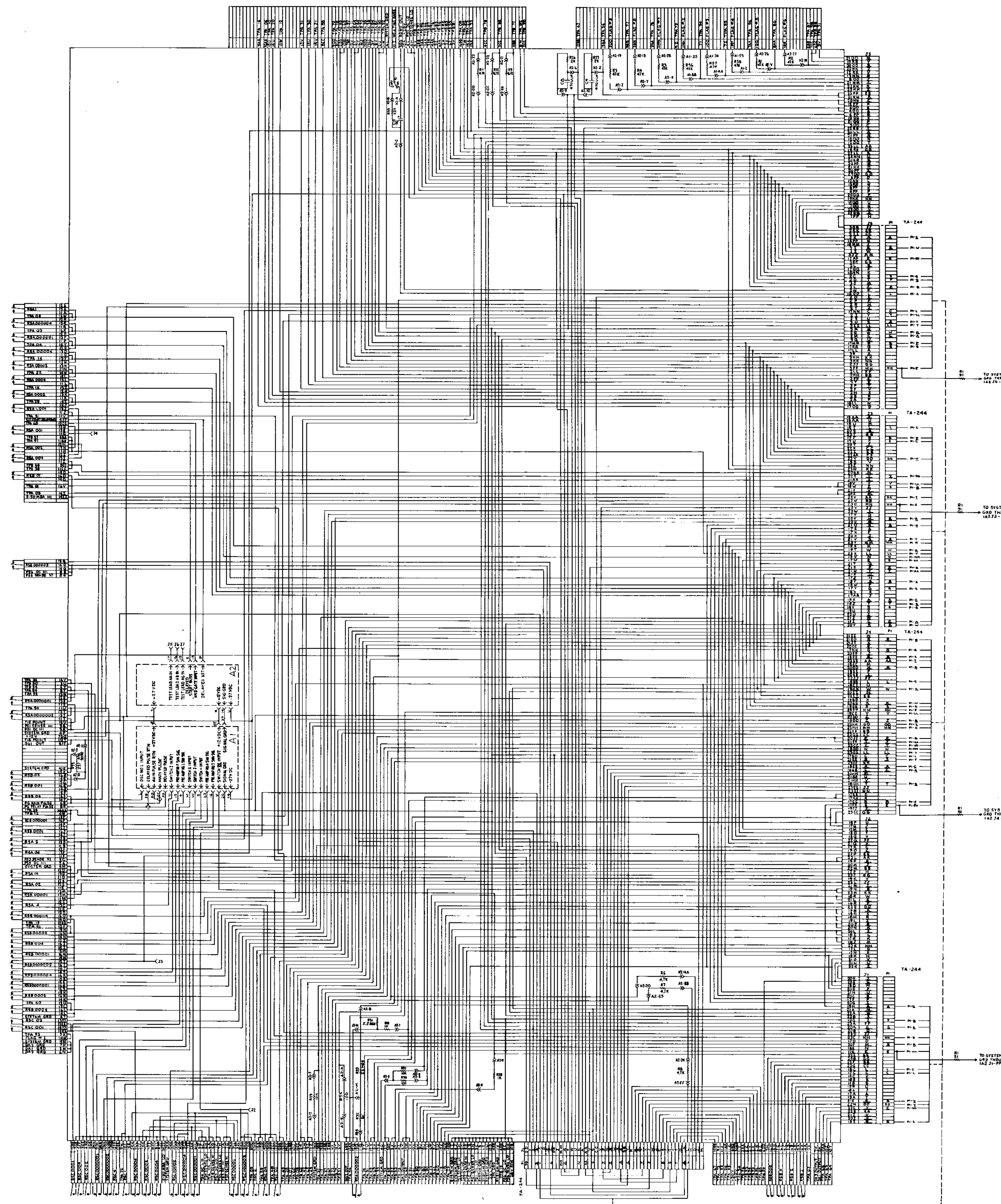

Figure 4-25. UUT 1500, Signal Data Converter Assembly (Survey Hook-Up) Interconnection Diagram.



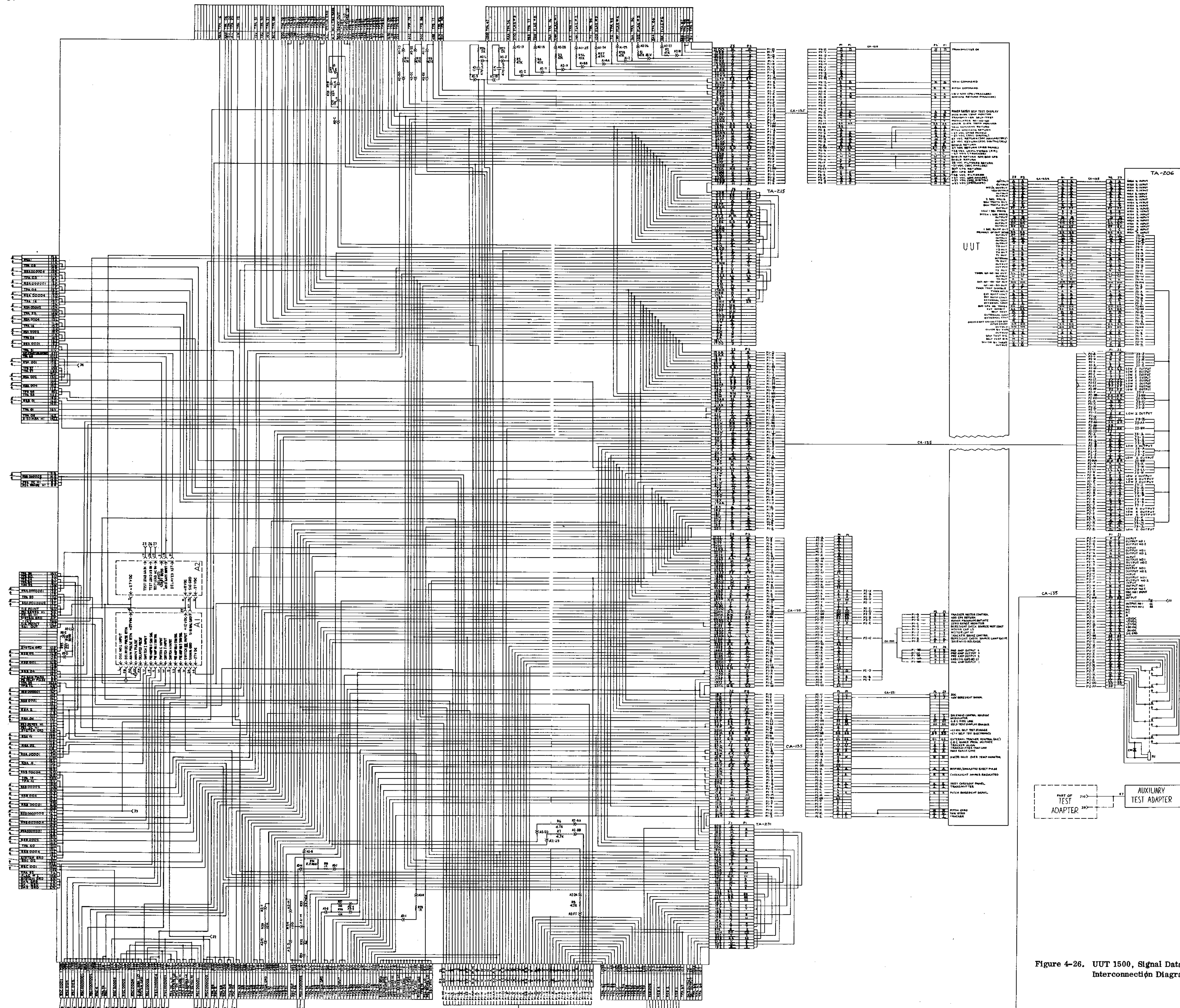

Figure 4-26. UUT 1500, Signal Data Converter Assembly (Dynamic Hook-Up) Interconnection Diagram.

C1

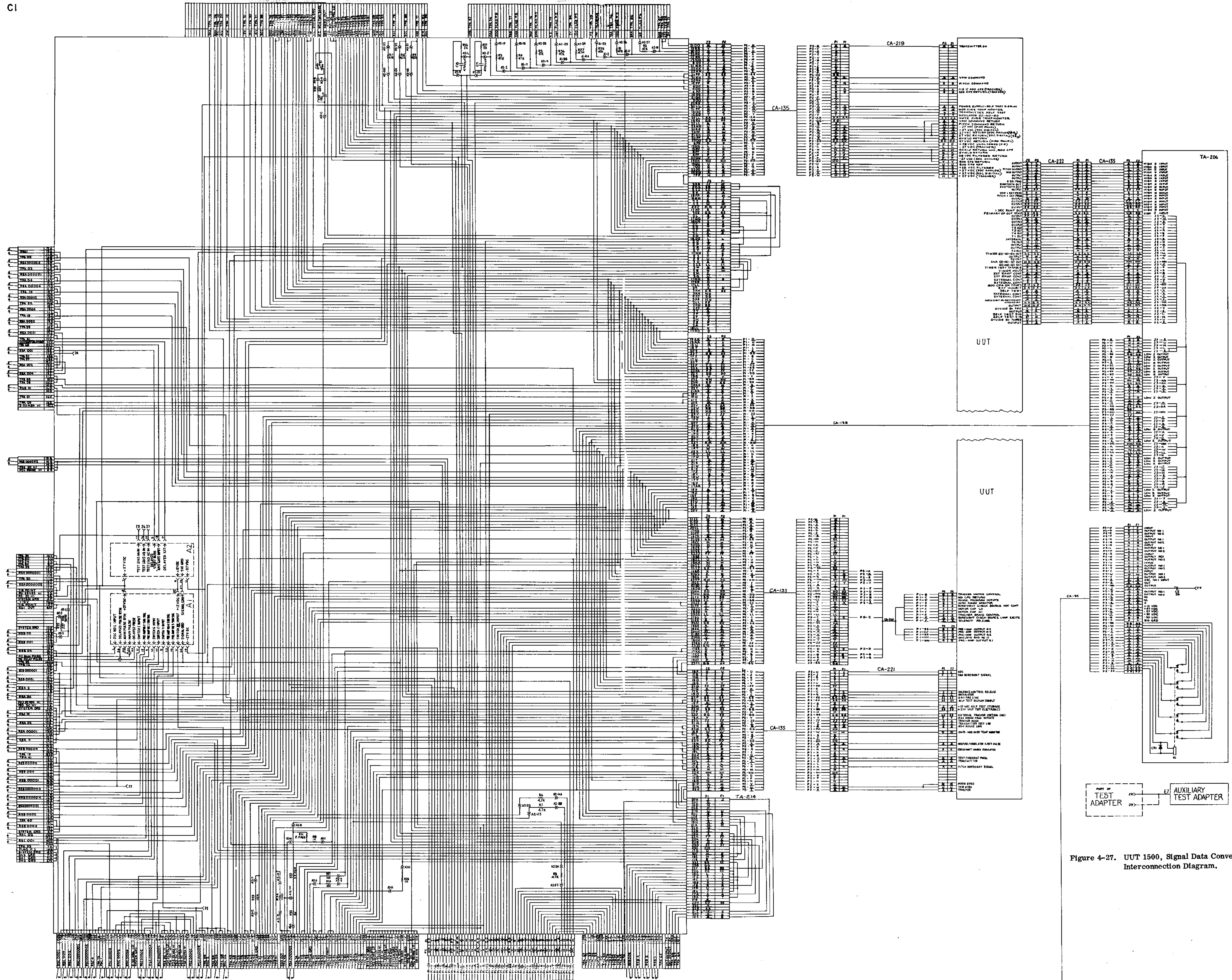

Figure 4-27. UUT 1500, Signal Data Converter Assembly (Go-Chain Cable Change 1) Interconnection Diagram.

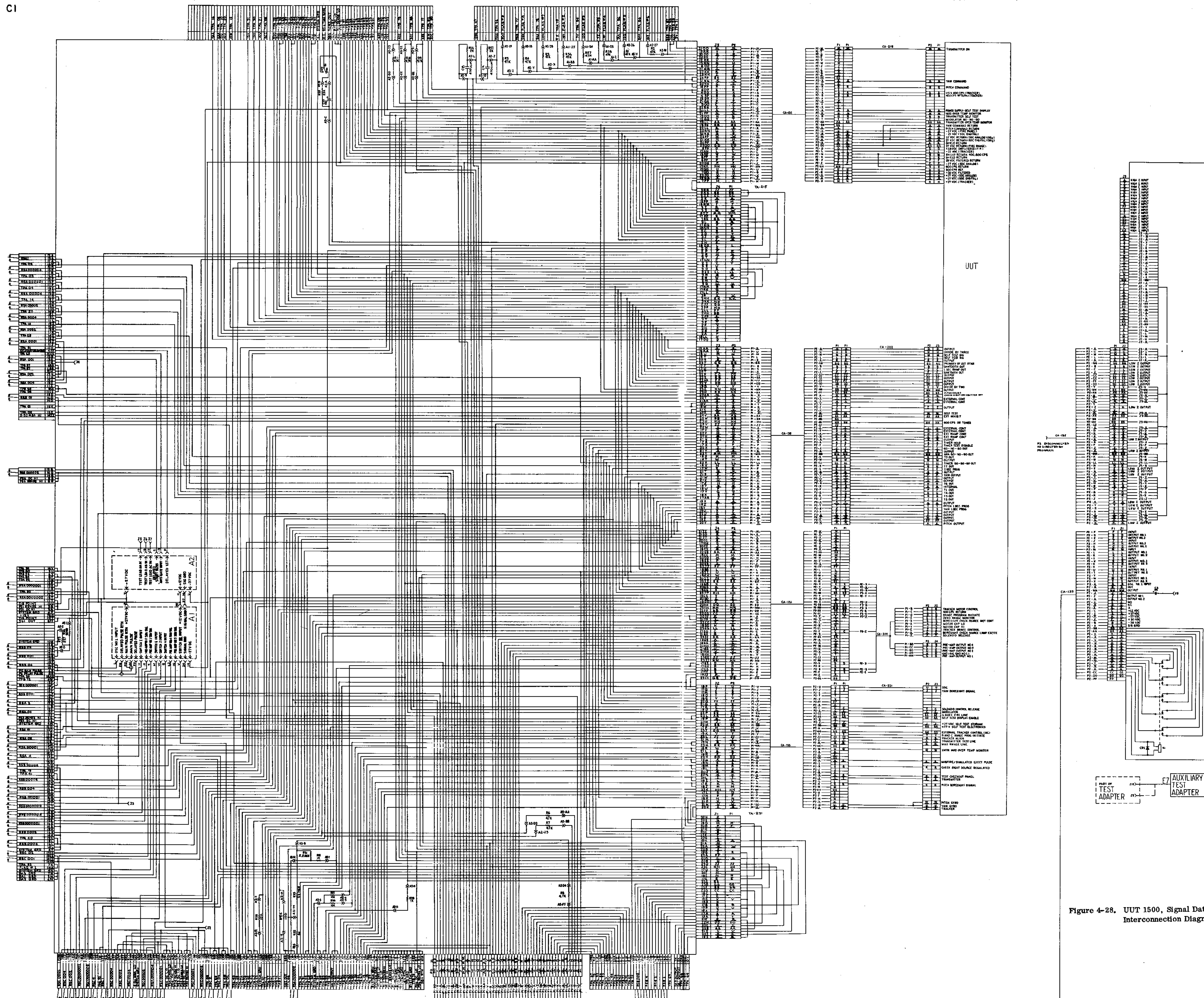

Figure 4-28. UUT 1500, Signal Data Converter Assembly (Go-Chain Cable Change 2) Interconnection Diagram.

Section II. UTILIZING SQUIB TYPE PATCHBOARDS

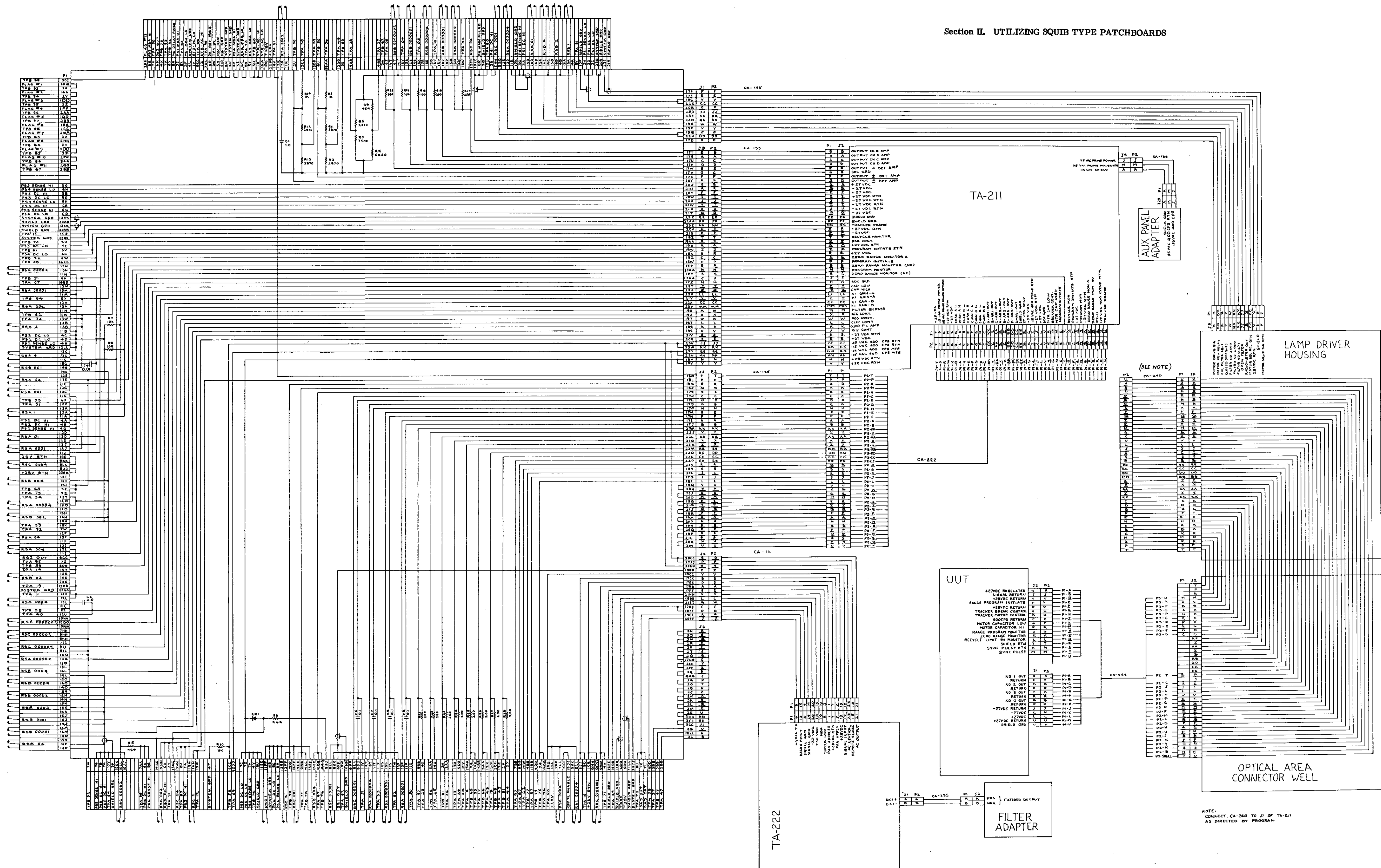

Figure 4-29. UUT 0100, Guided Missile Tracker Assembly Interconnection Diagram.

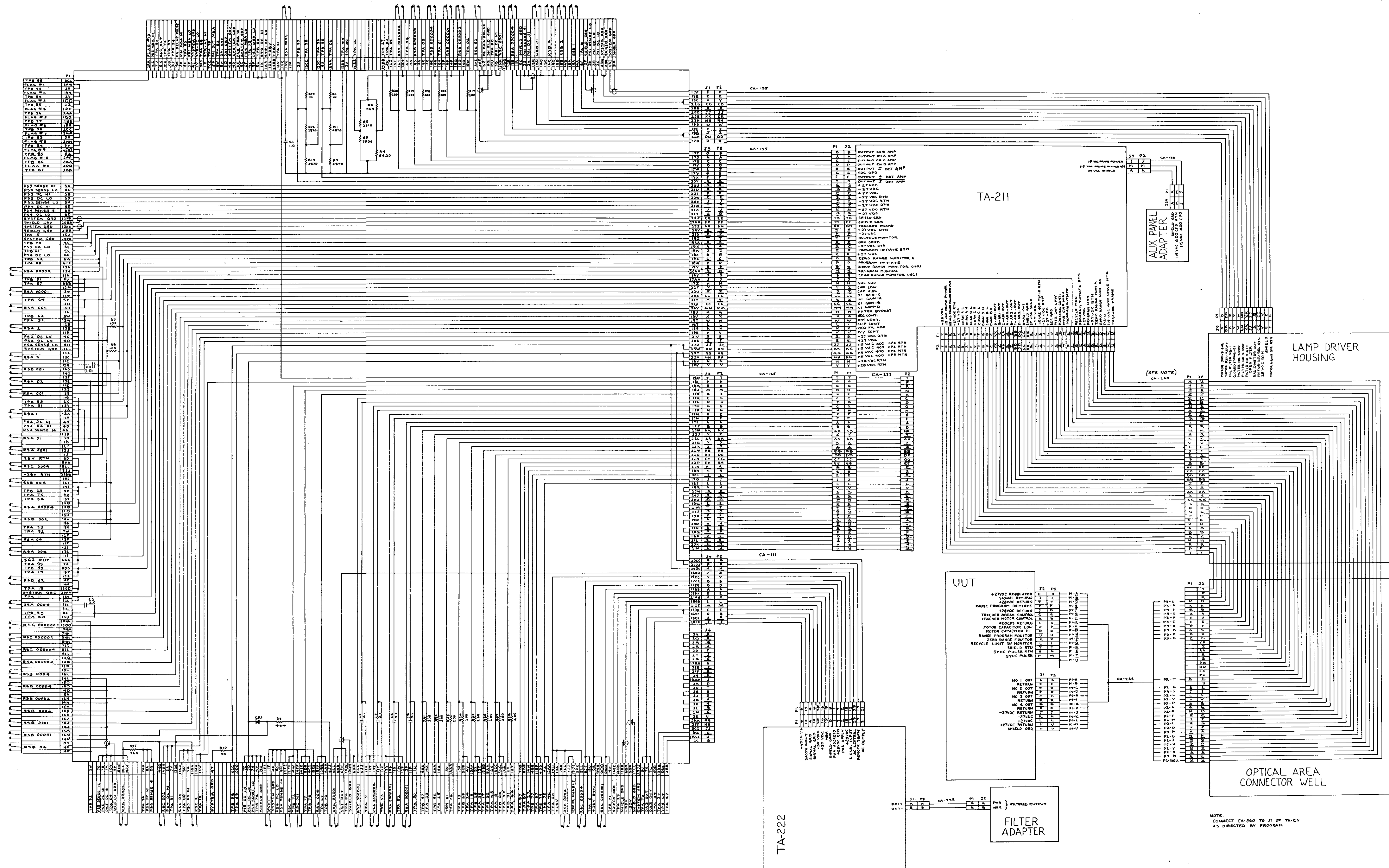

Figure 4-30. UUT 0100, Guided Missile Tracker Assembly (Go-Chain Cable Changes) Interconnection Diagram.

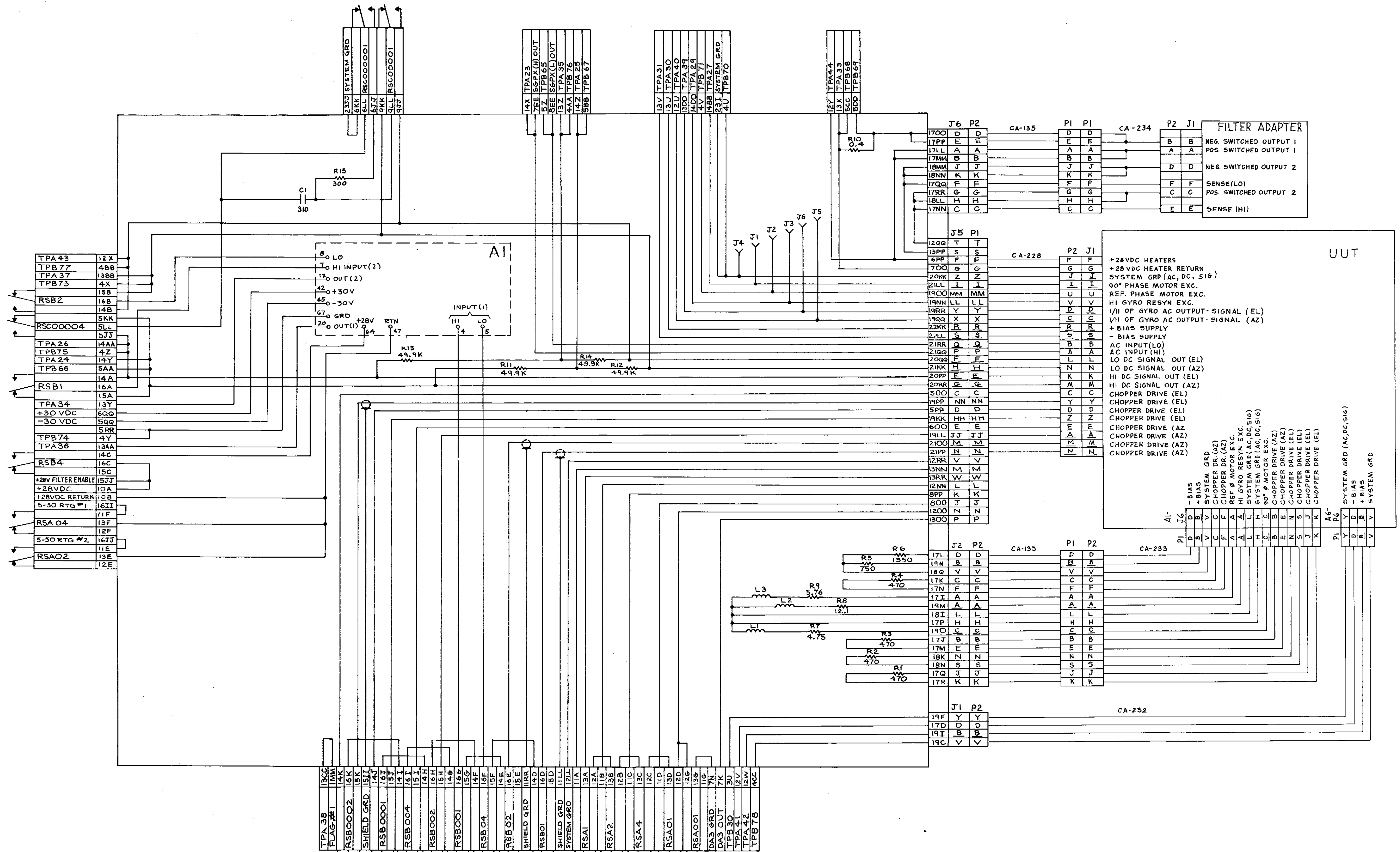

Figure 4-31. UUT 0200, Guided Missile Target Tracking, Rate Sensing Unit Interconnection Diagram.

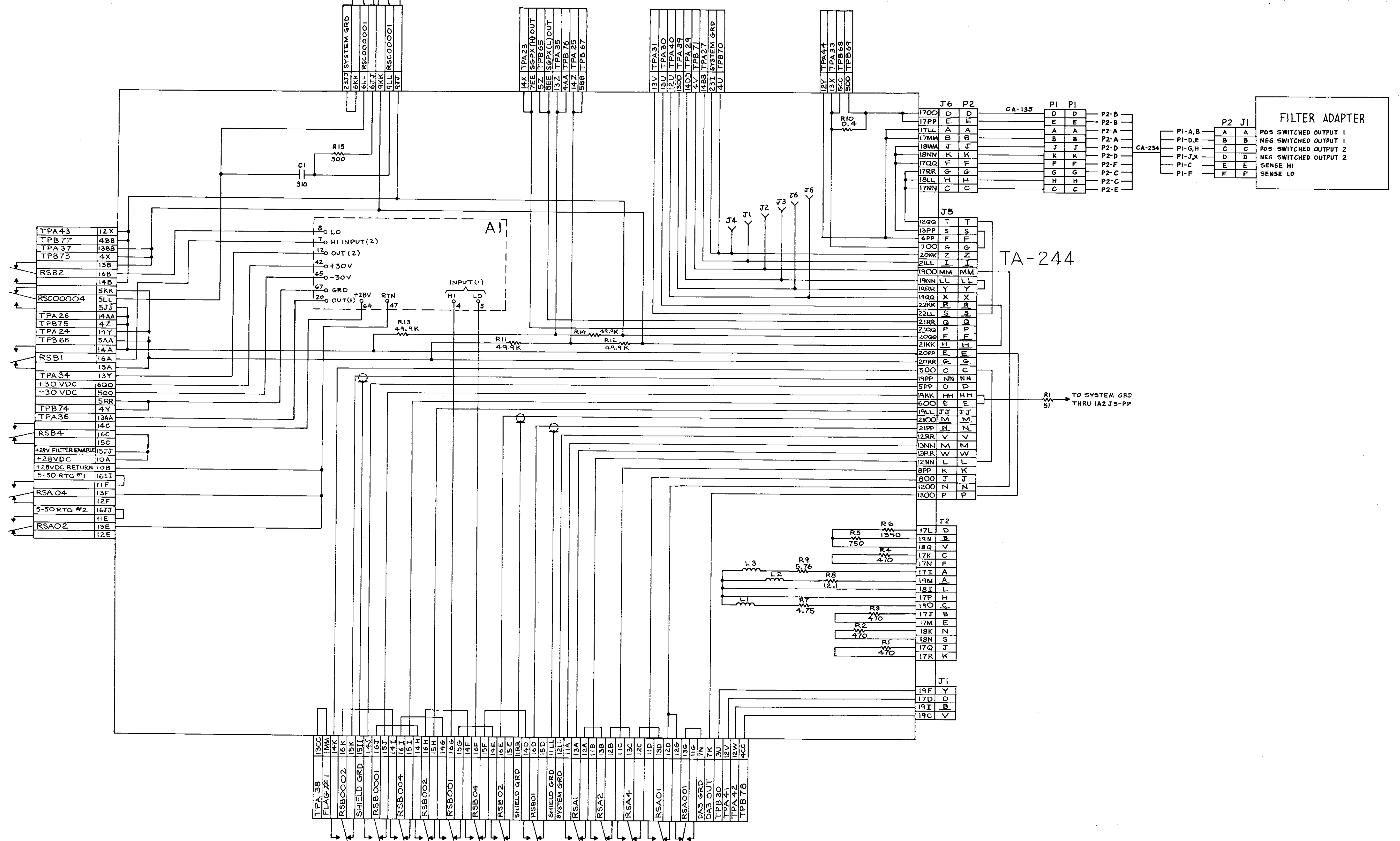

Figure 4-32. UUT 0200, Guided Missile Target Tracking, Rate Sensing Unit (Survey Hook-Up) Interconnection Diagram.

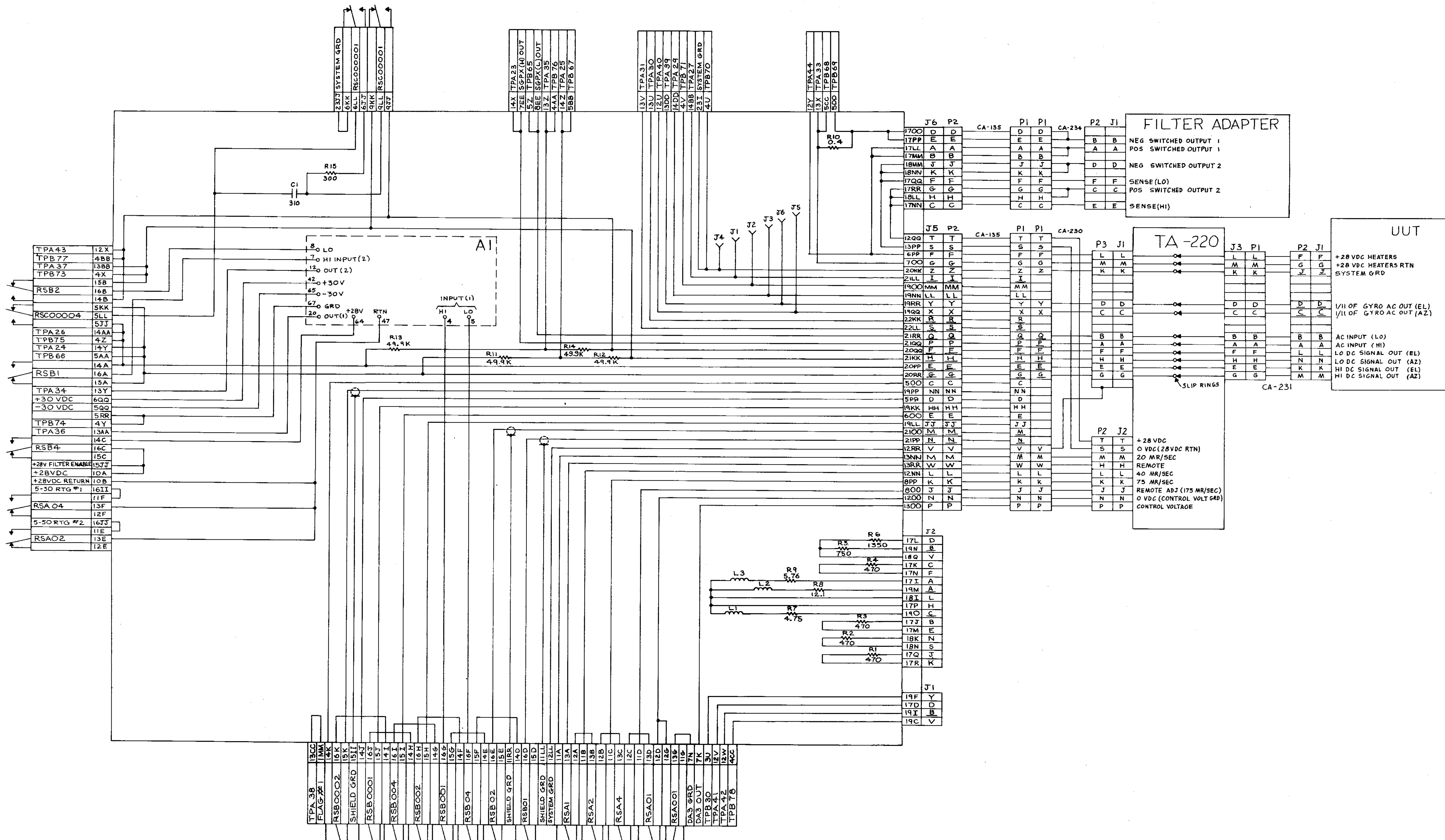

Figure 4-33. UUT 0200, Guided Missile Target Tracking, Rate Sensing Unit (Dynamic Hook-Up) Interconnection Diagram.



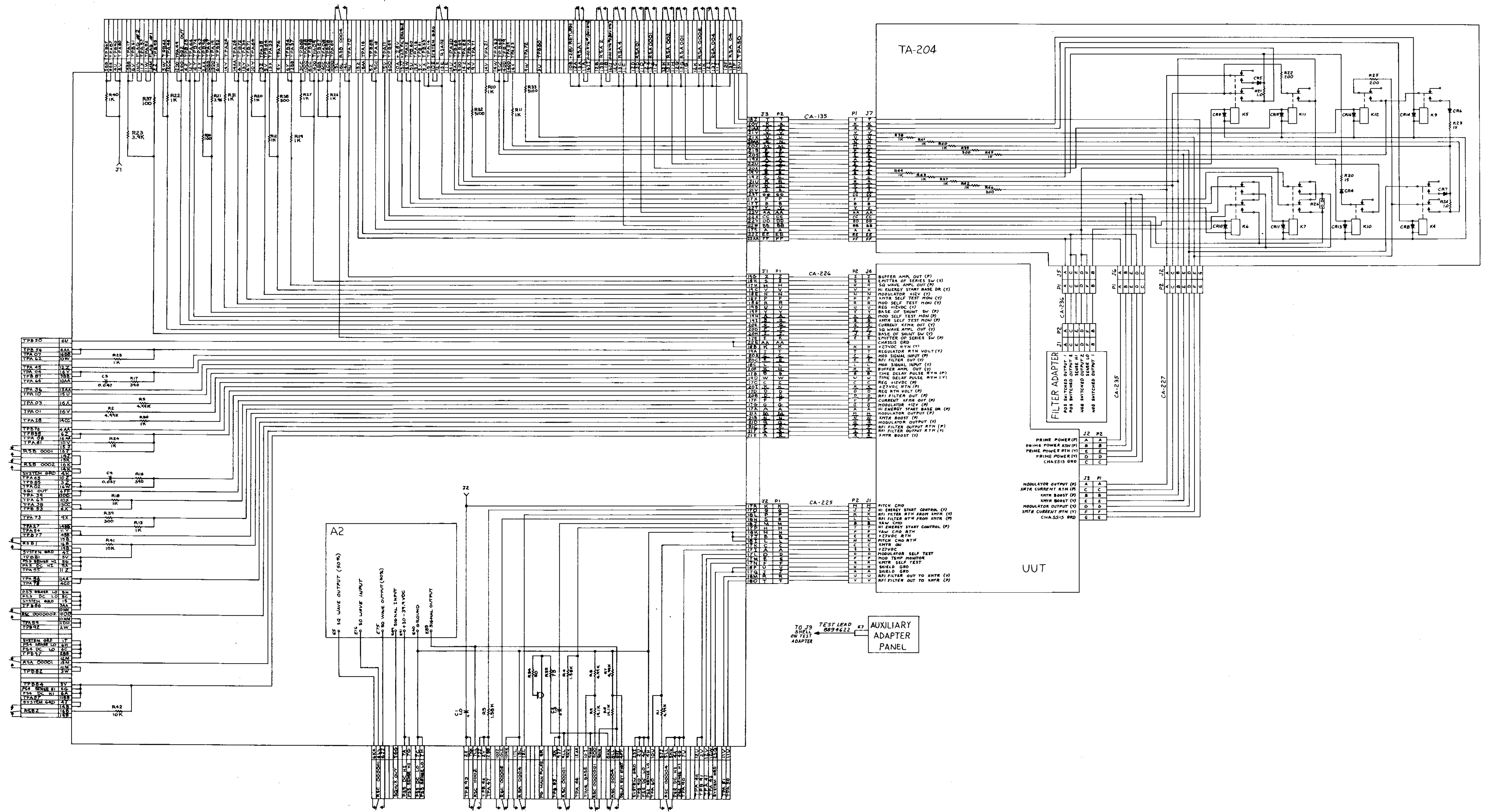

Figure 4-34. UUT 0500, Modulator Assembly Interconnection Diagram.

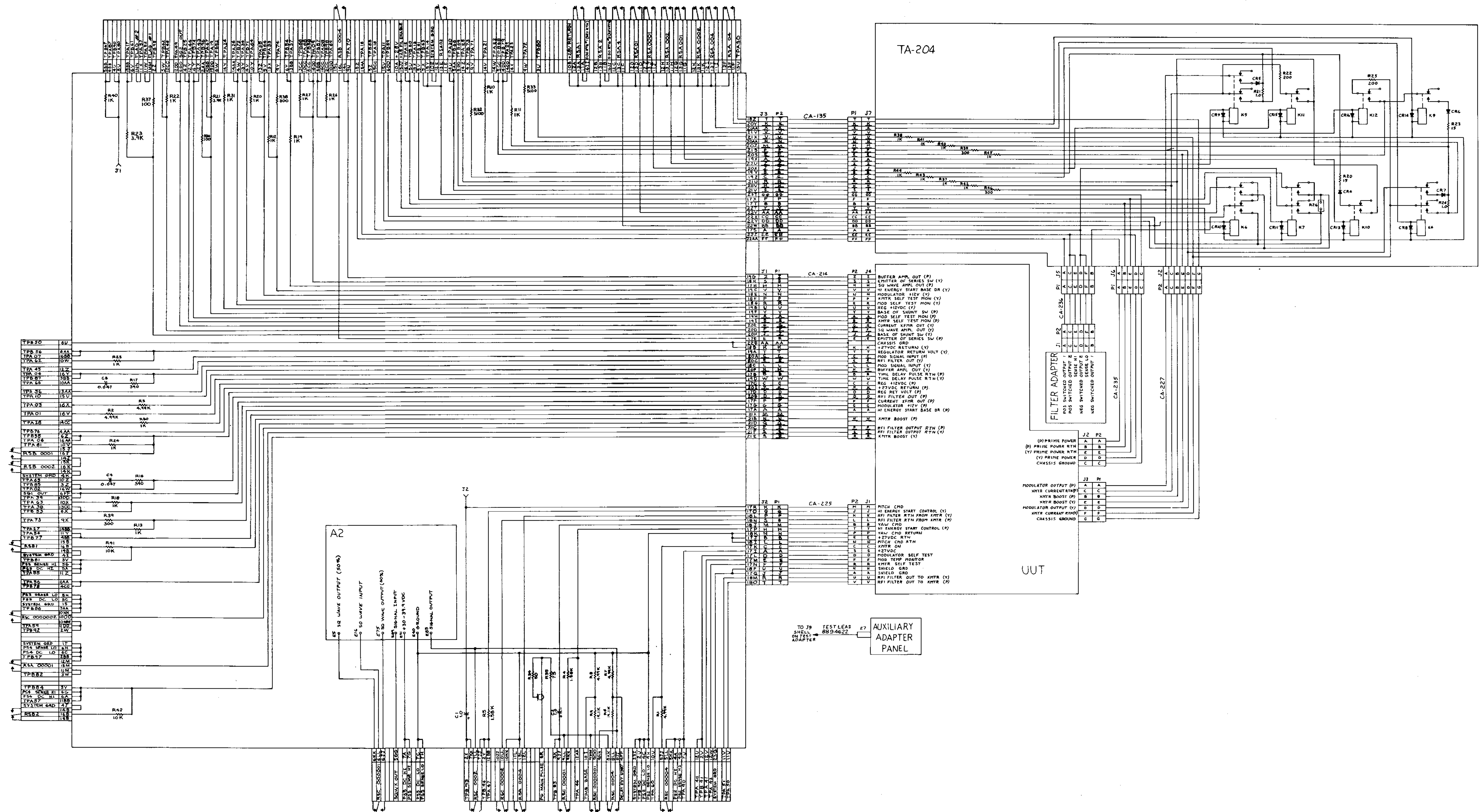

Figure 4-35. UUT 0500, Modulator Assembly (Go-Chain Cable Changes) Interconnection Diagram.

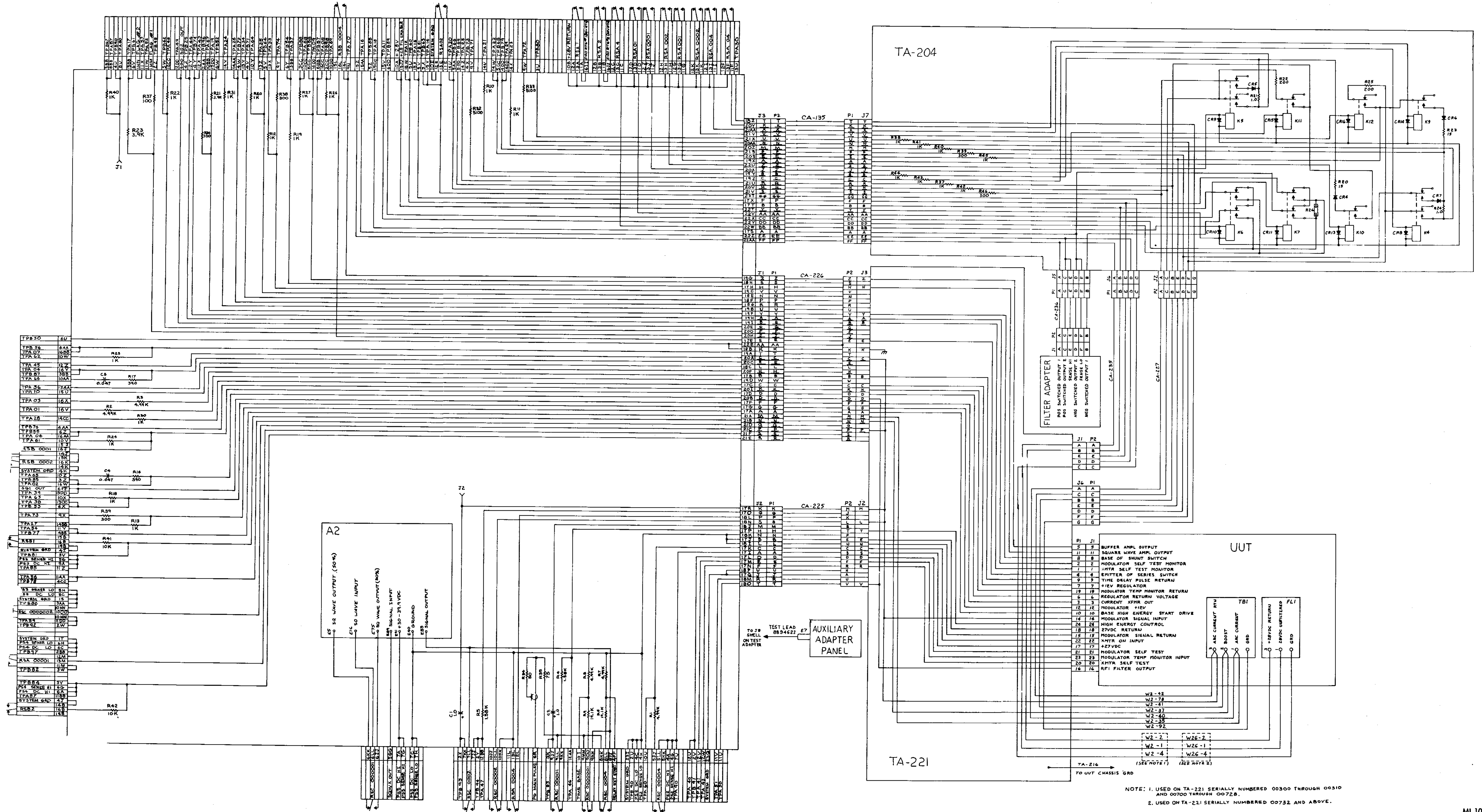

Figure 4-36. UUT 0510, Modulator Subassembly Interconnection Diagram.

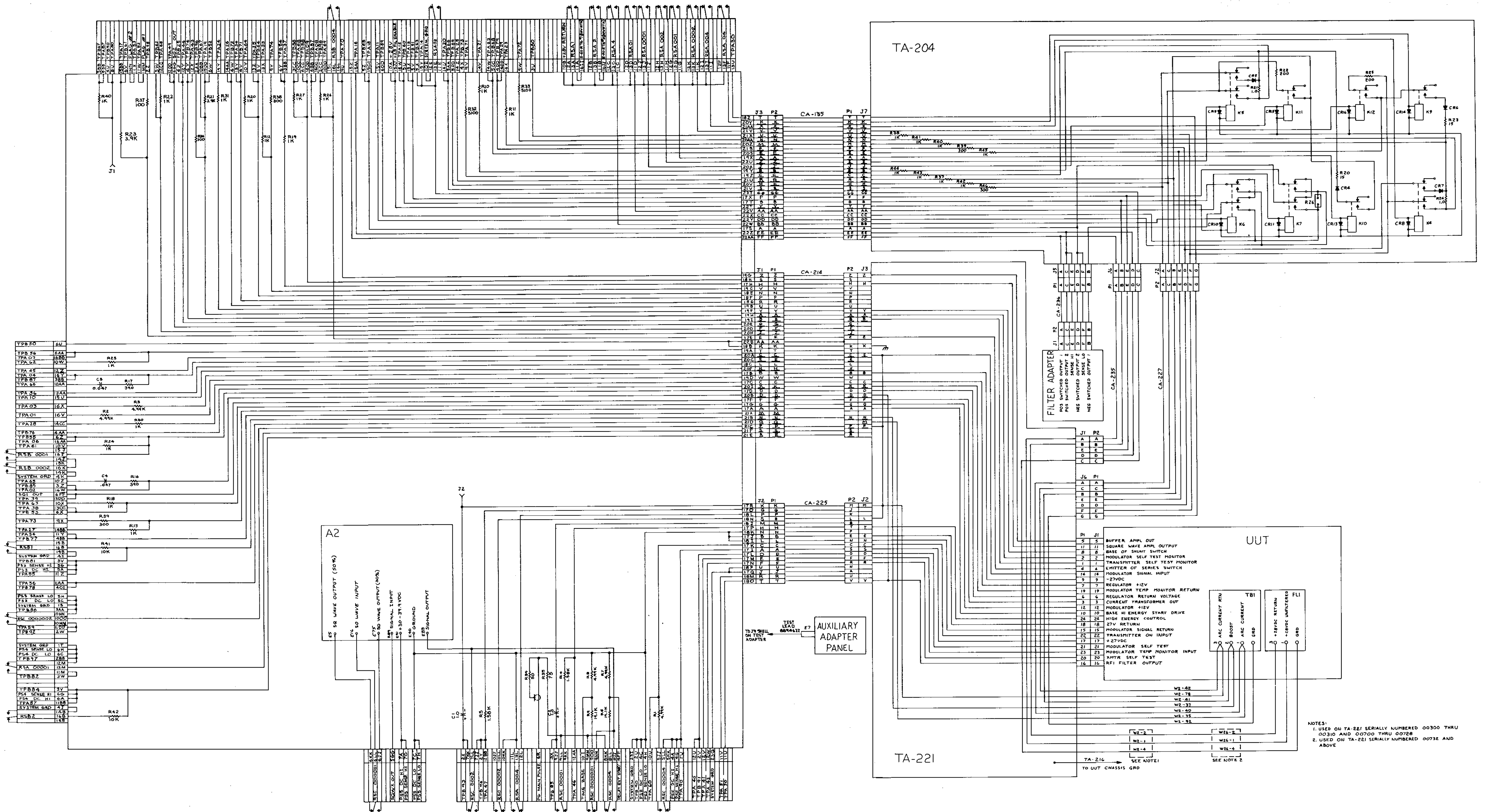

Figure 4-37. UUT 0510, Modulator Subassembly (Test Fixture Configuration Variation) Interconnection Diagram.

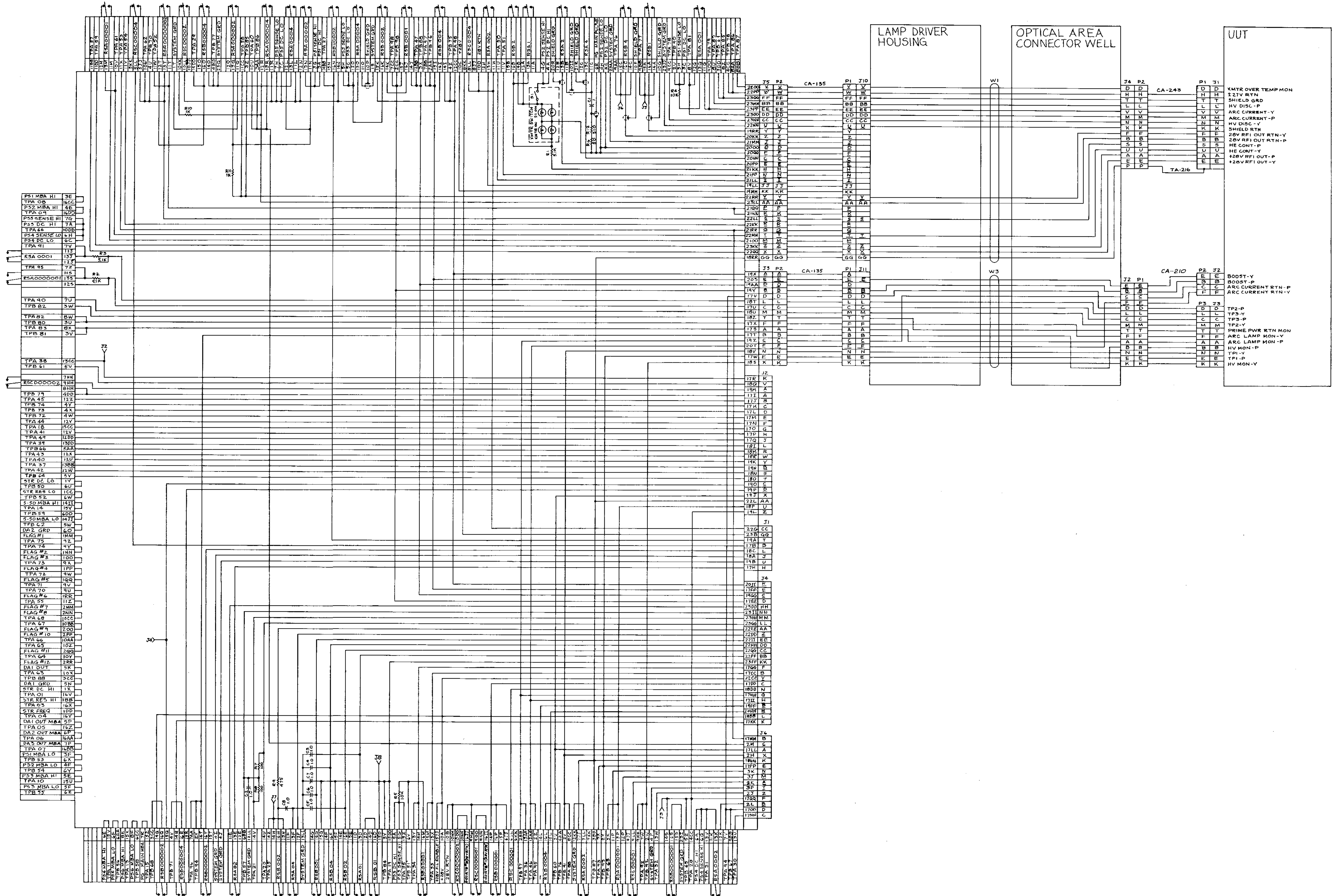

Figure 4-38. UUT 0600, Transmitter Assembly Interconnection Diagram.

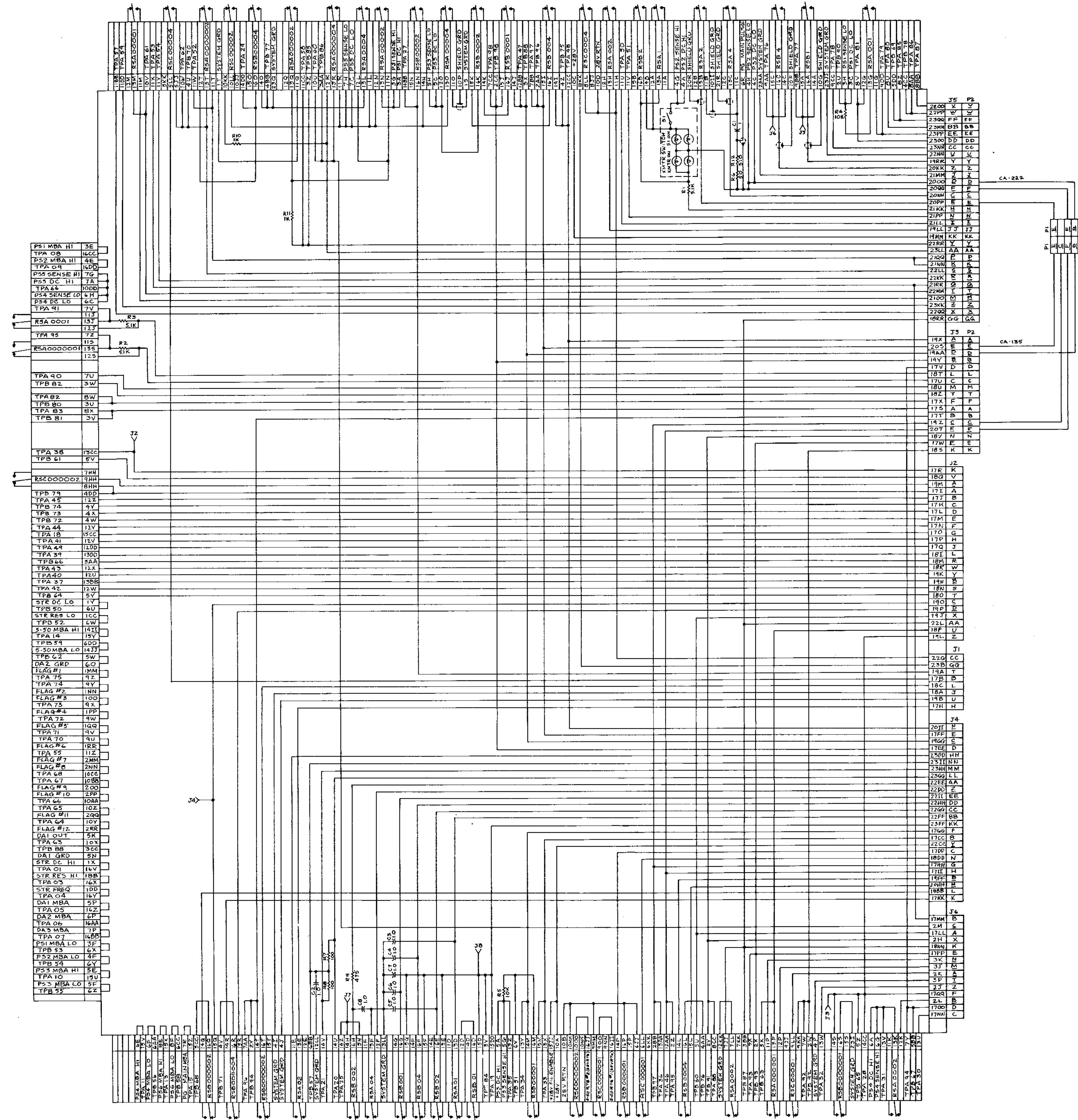

Figure 4-39. UUT 0600, Transmitter Assembly (Survey Hook-Up) Interconnection Diagram.

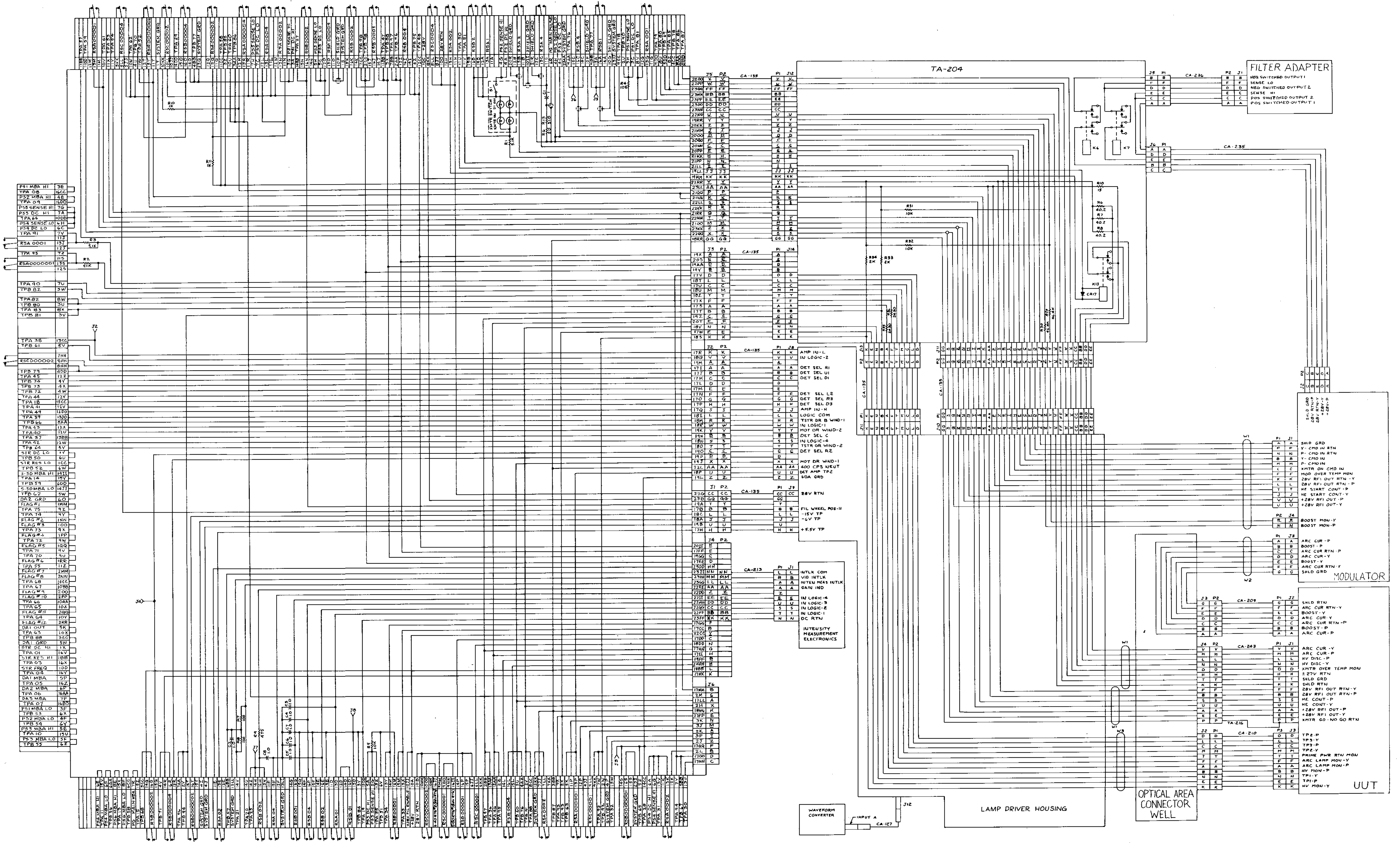

Figure 4-40. UUT 0600, Transmitter Assembly (Dynamic Hook-Up) Interconnection Diagram.

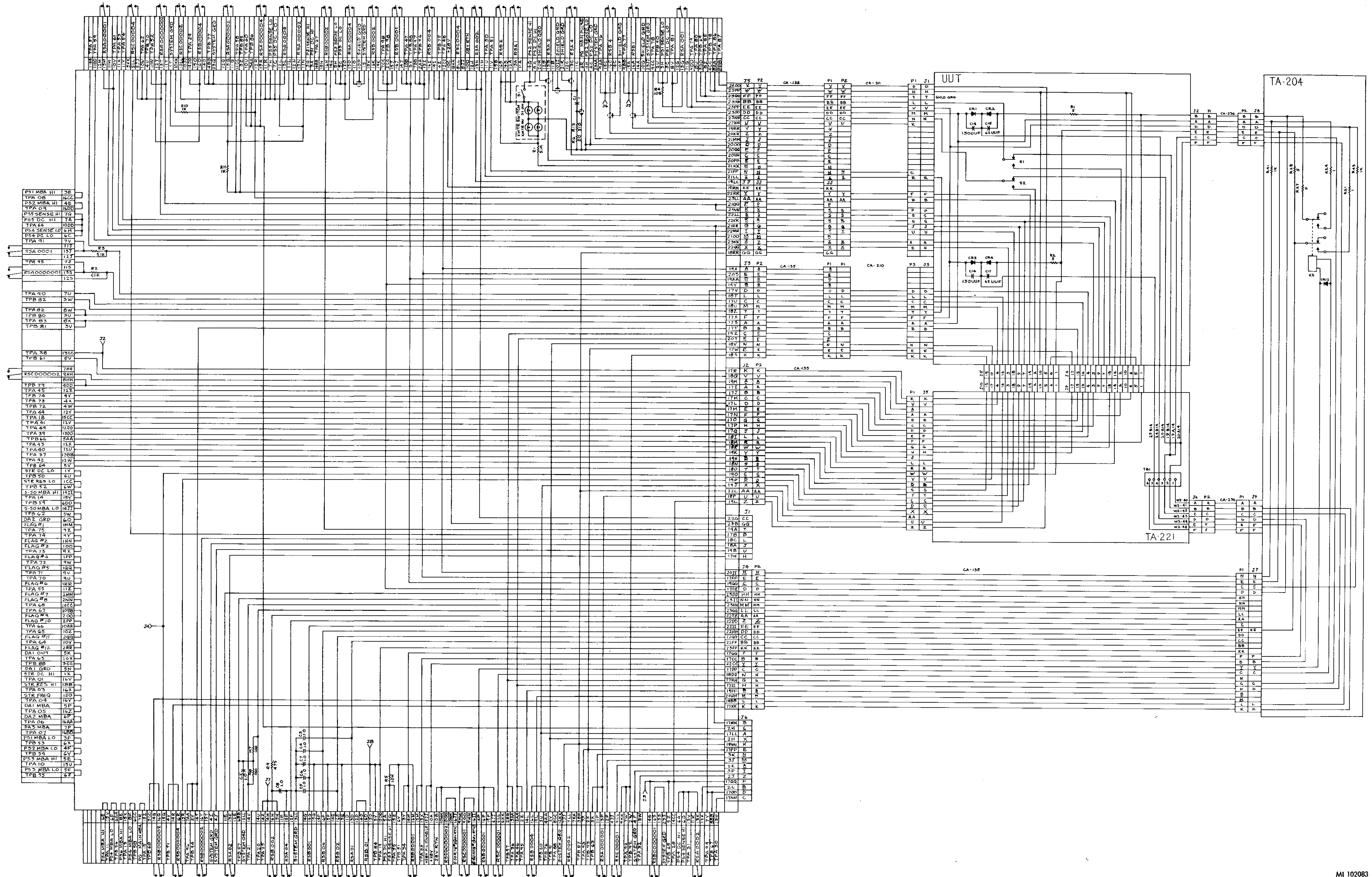

Figure 4-41. UUT 0610, Transmitter Filter Panel Assembly Interconnection Diagram.



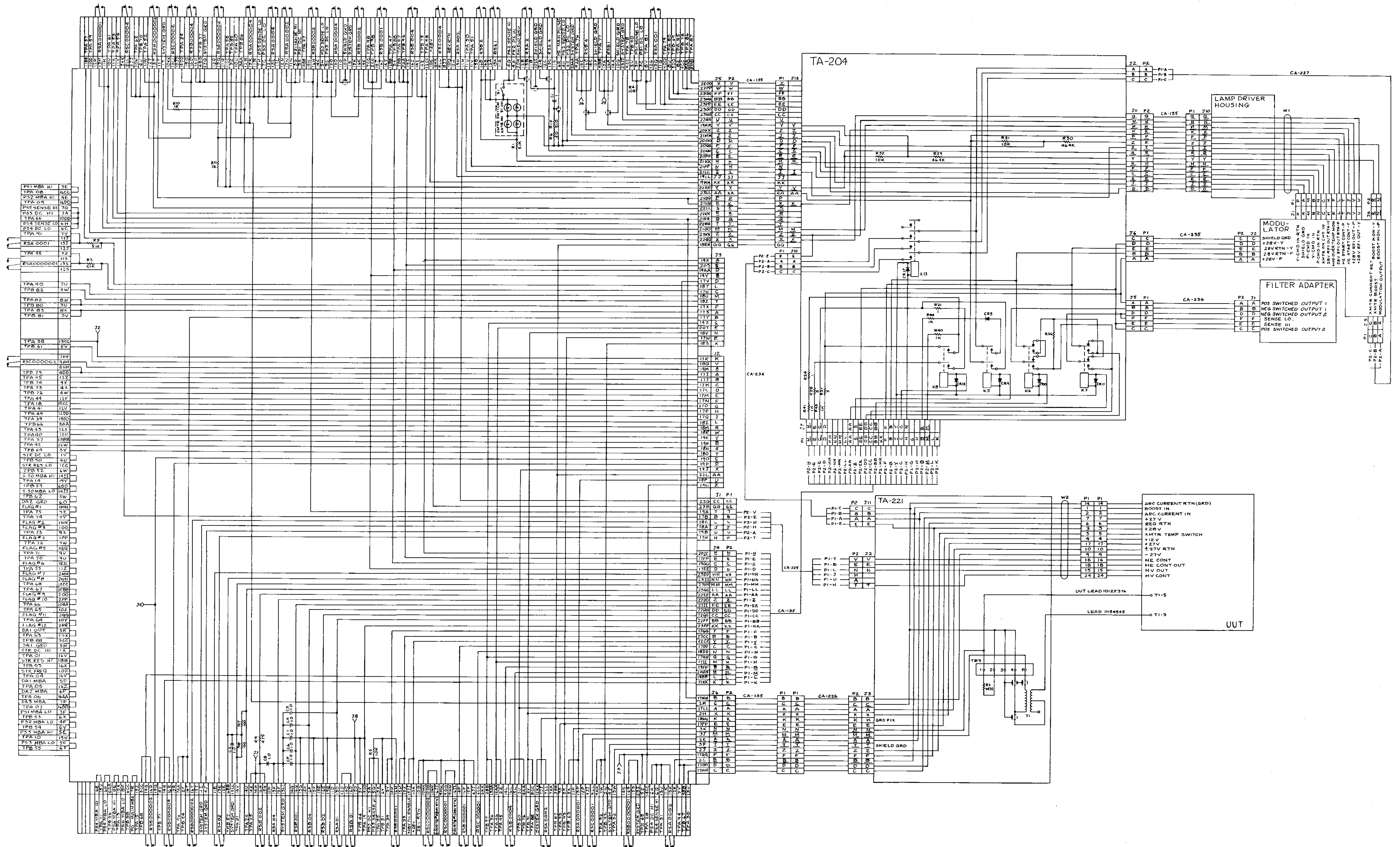

Figure 4-42. UUT 0620, Transmitter Starter Electronics Assembly Interconnection Diagram.

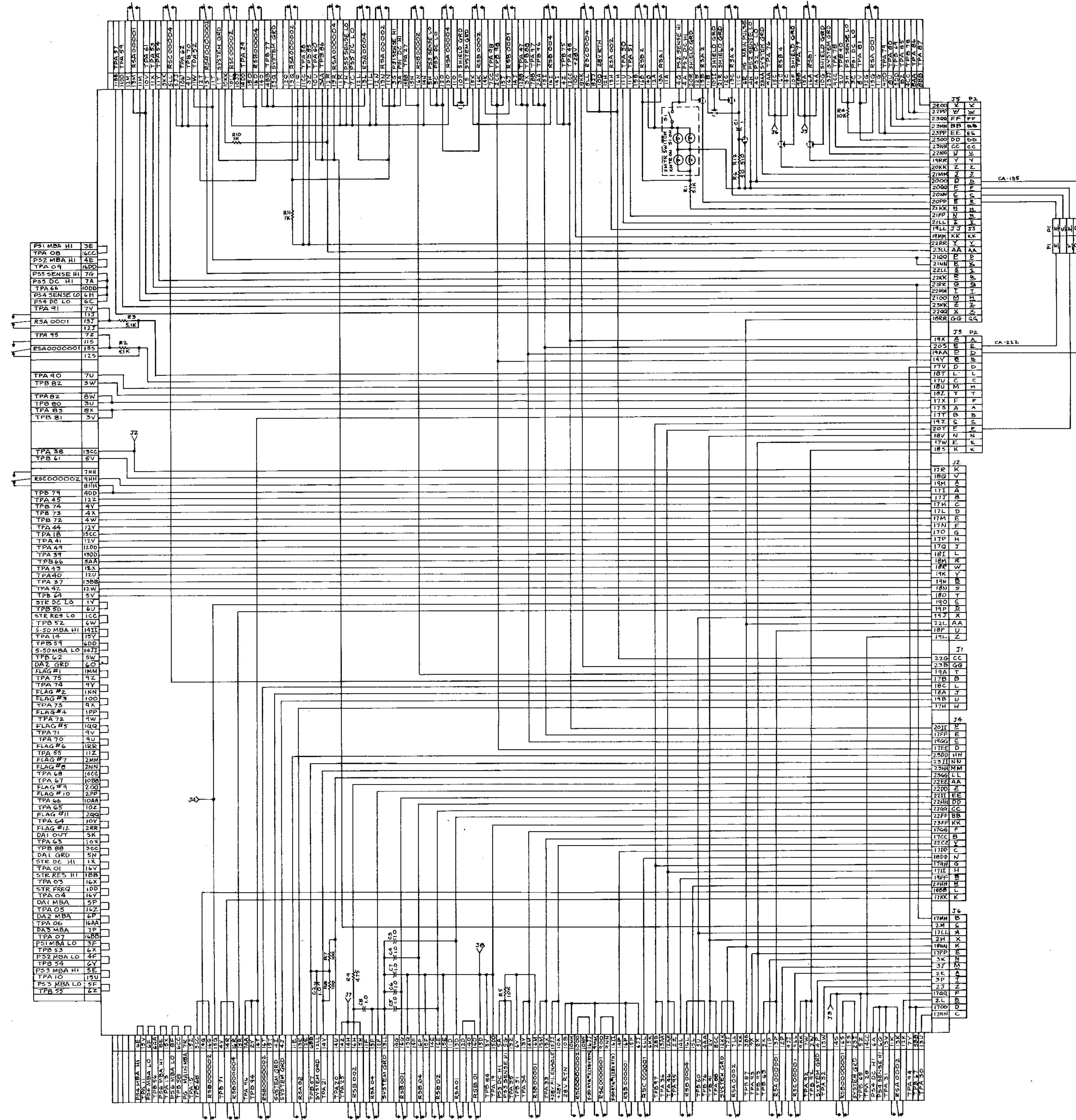

Figure 4-43. UUT 0620, Transmitter Starter Electronics Assembly (Survey Hook-Up) Interconnection Diagram.

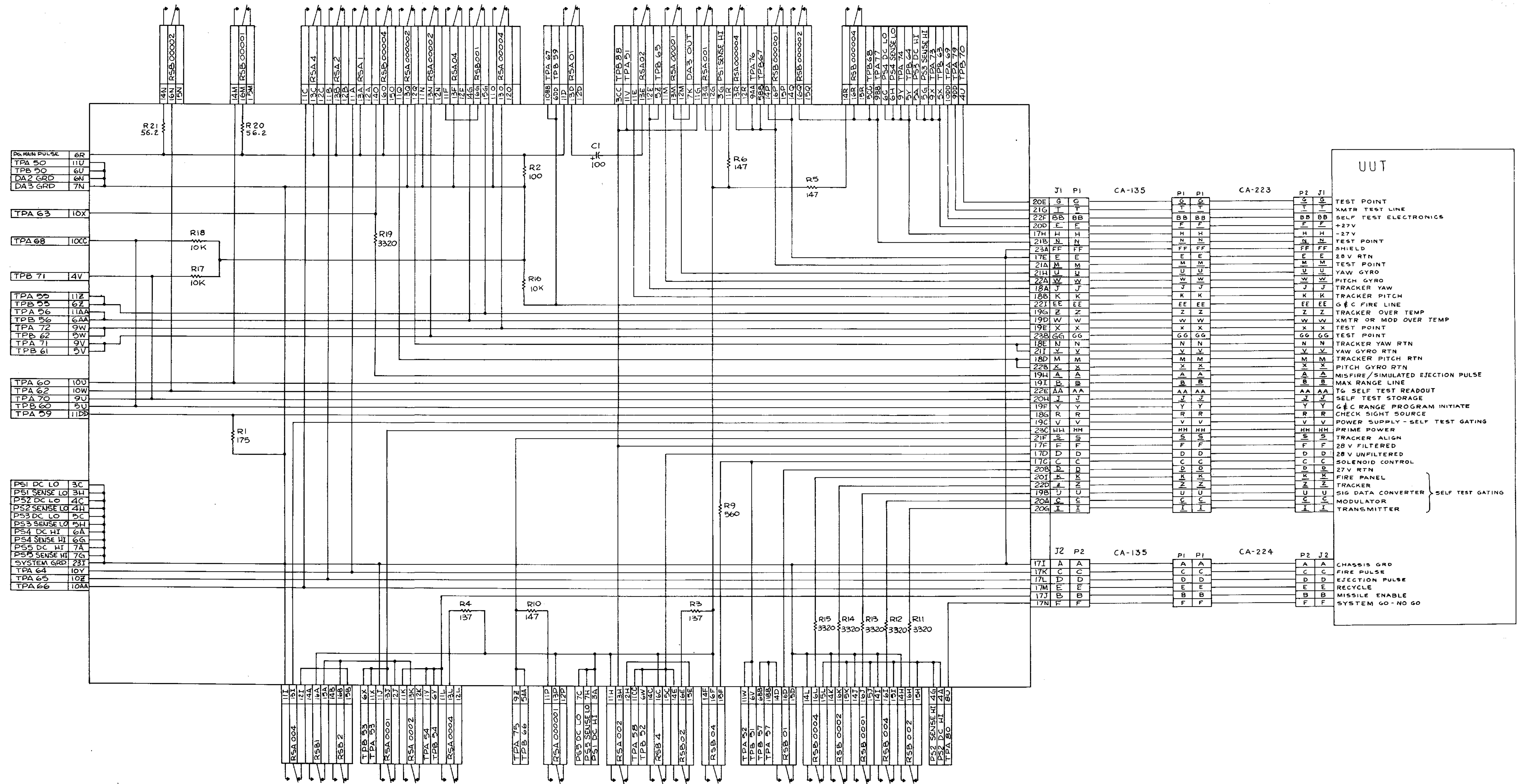

Figure 4-44. UUT 0700, Test Checkout Panel Assembly Interconnection Diagram.

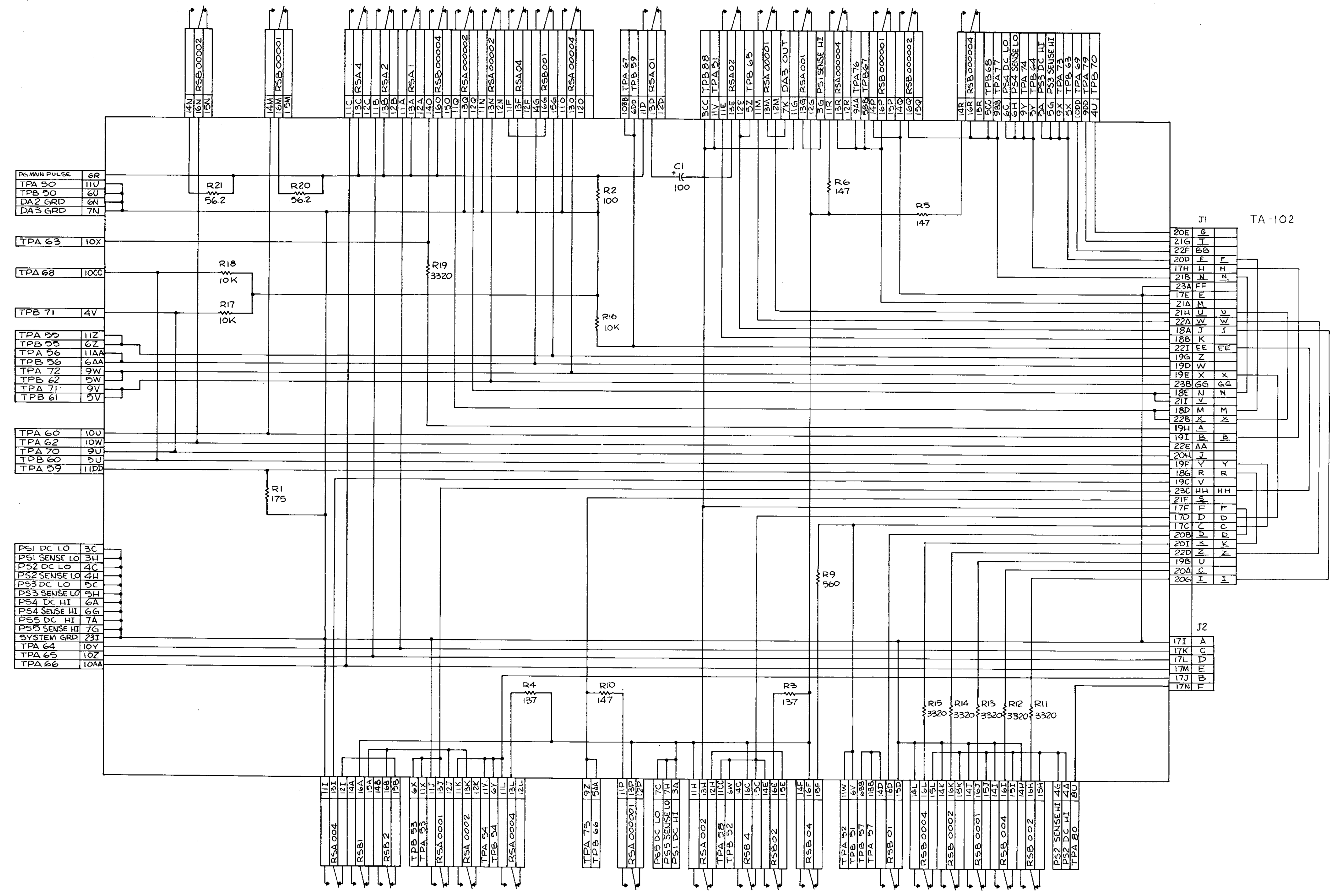

Figure 4-45. UUT 0700, Test Checkout Panel Assembly (Survey Hook-Up) Interconnection Diagram.

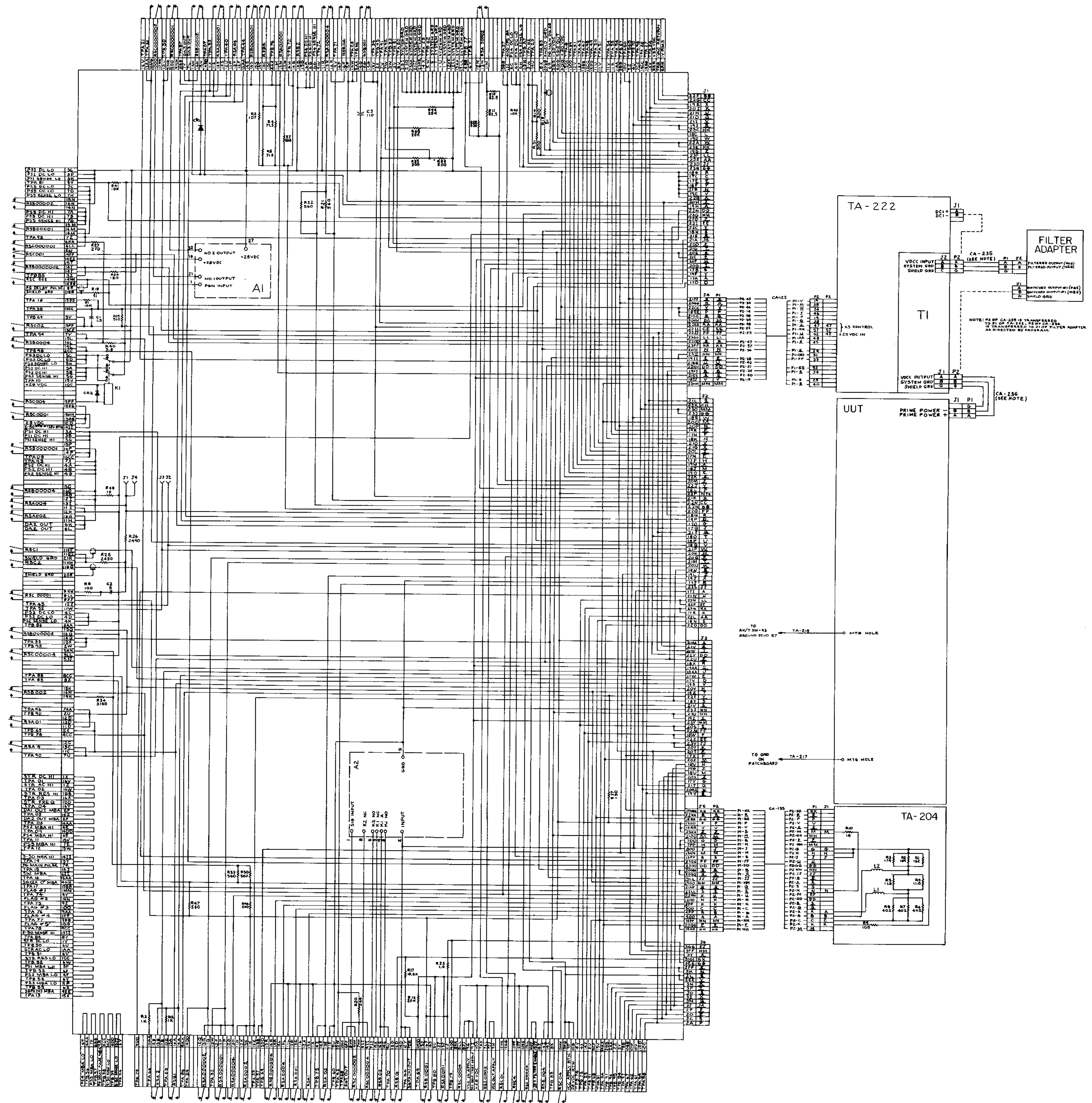

Figure 4-46. UUT 0800, Power Supply Assembly Interconnection Diagram.

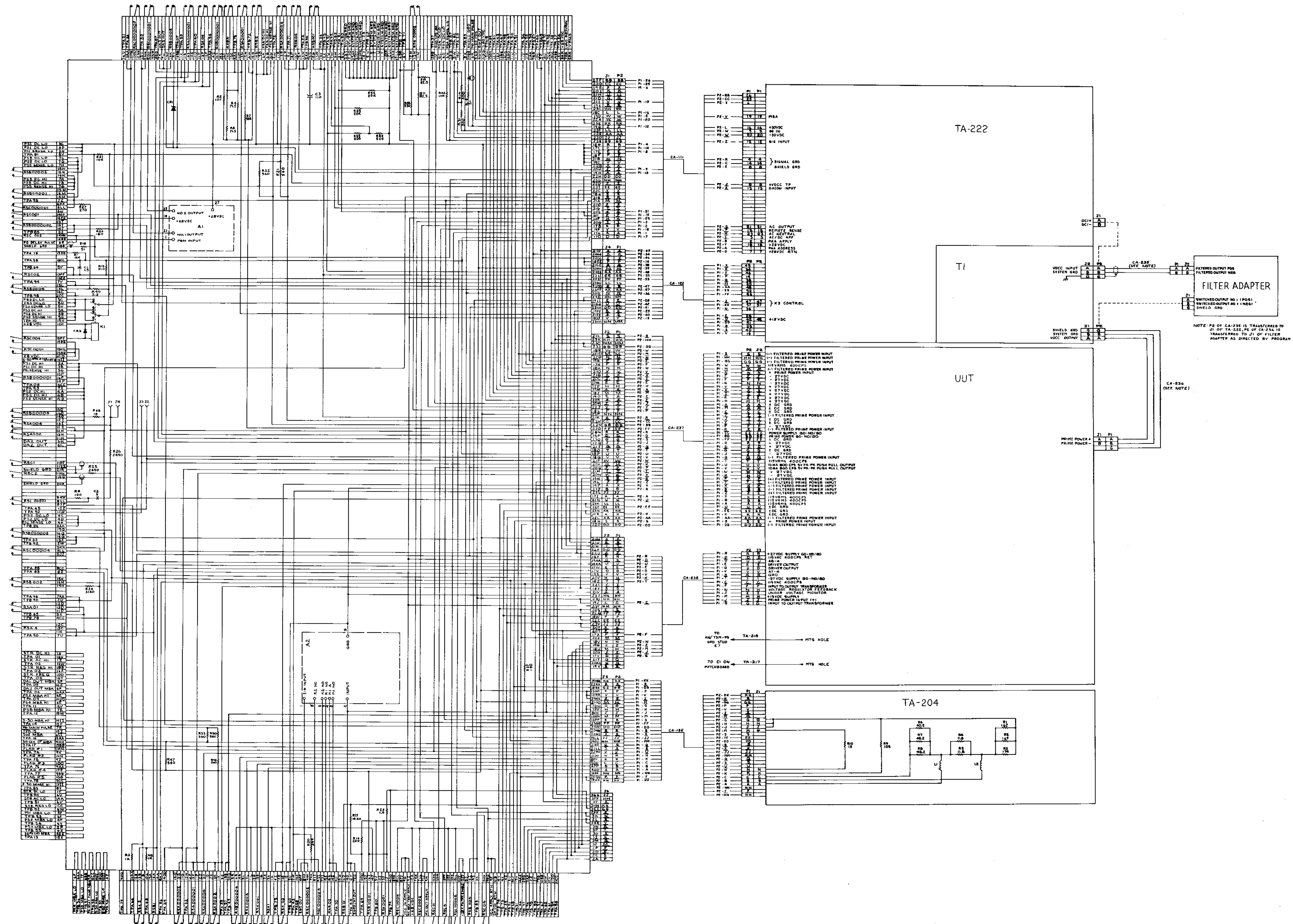

Figure 4-47. UUT 0800, Power Supply Assembly (Go-Chain Cable Changes) Interconnection Diagram.

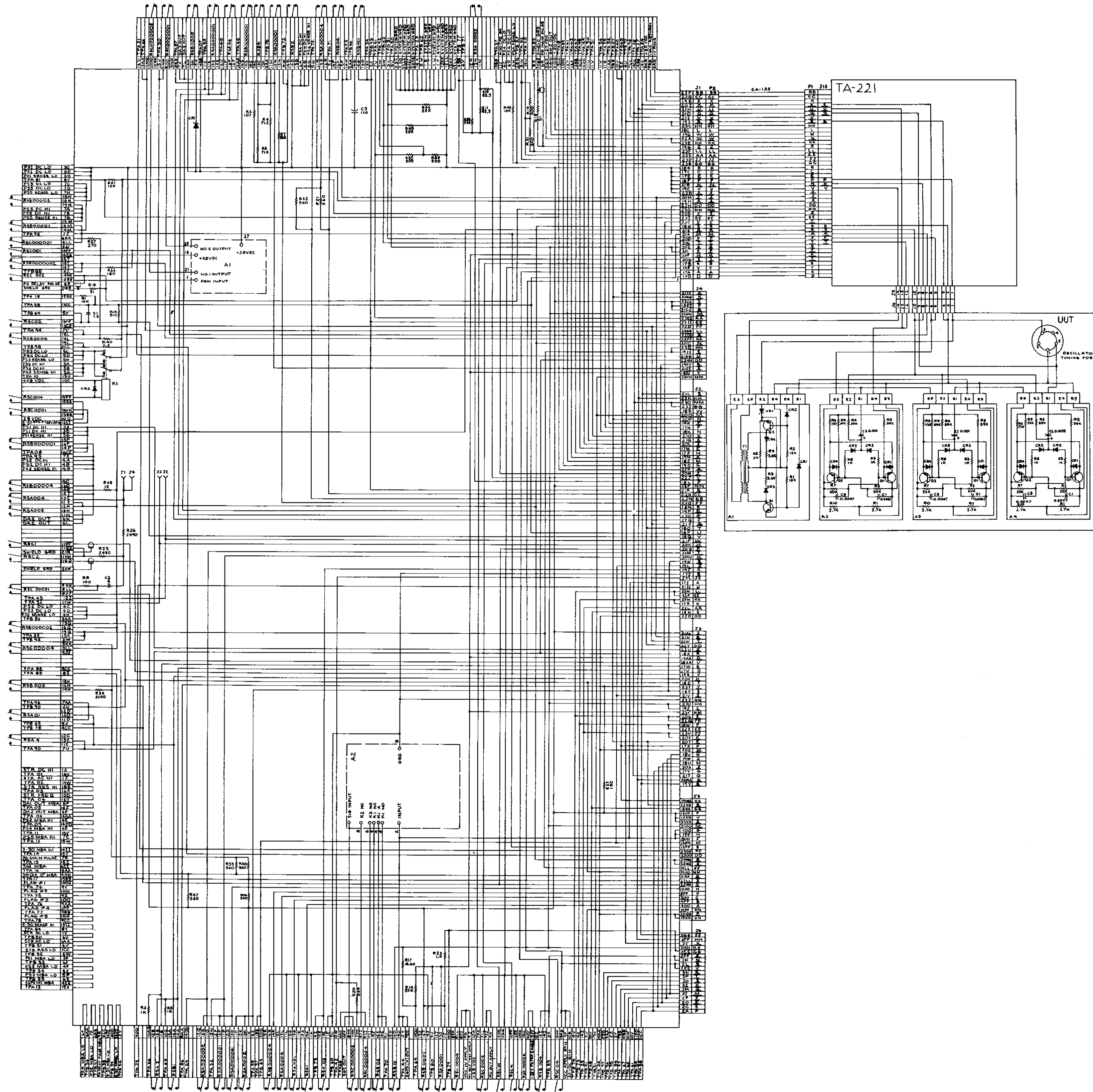

Figure 4-48. UUT-0830, Count Down Module Interconnection Diagram.

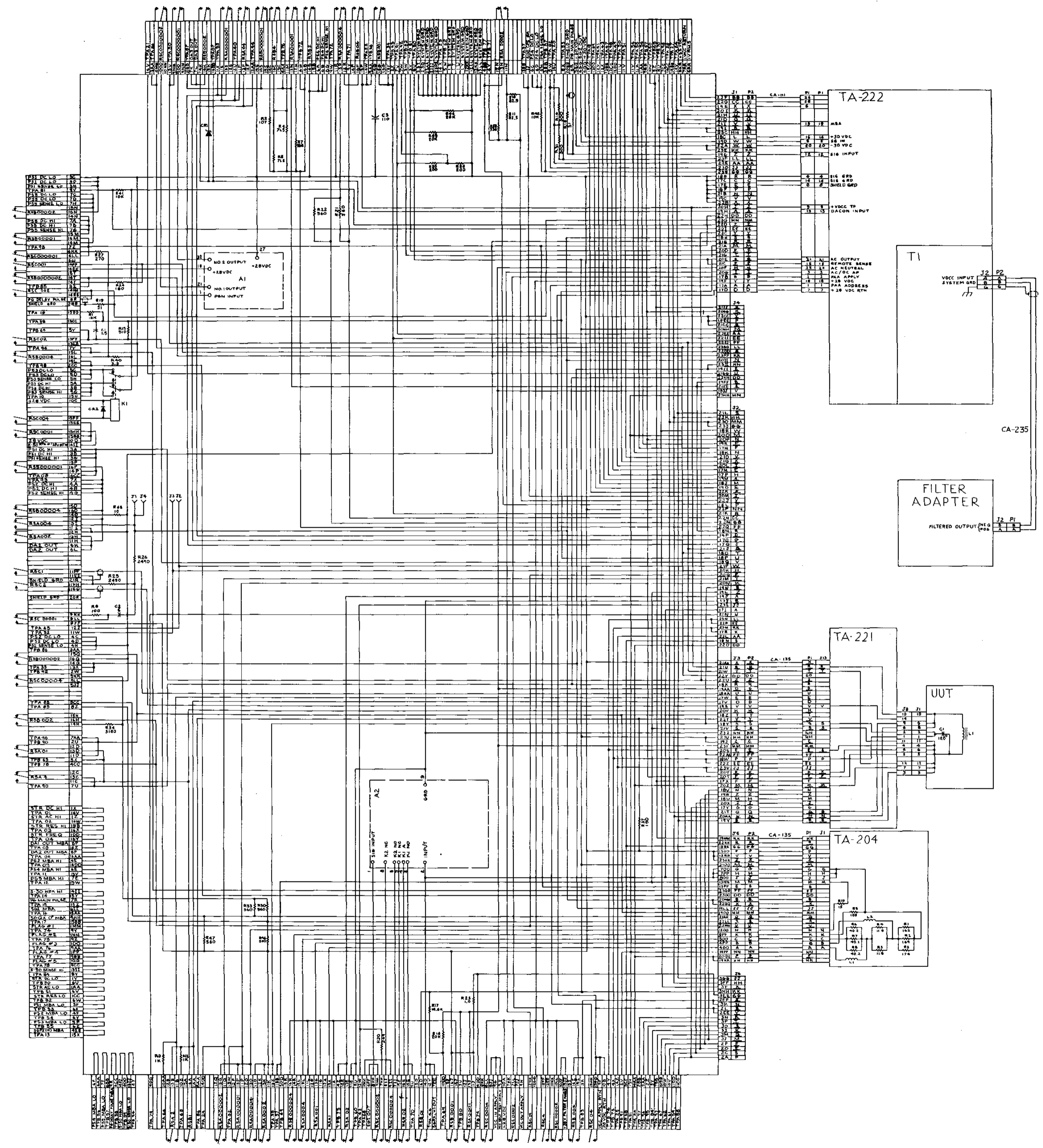

Figure 4-49. UUT 0880, Prime Power Filter Module Interconnection Diagram.



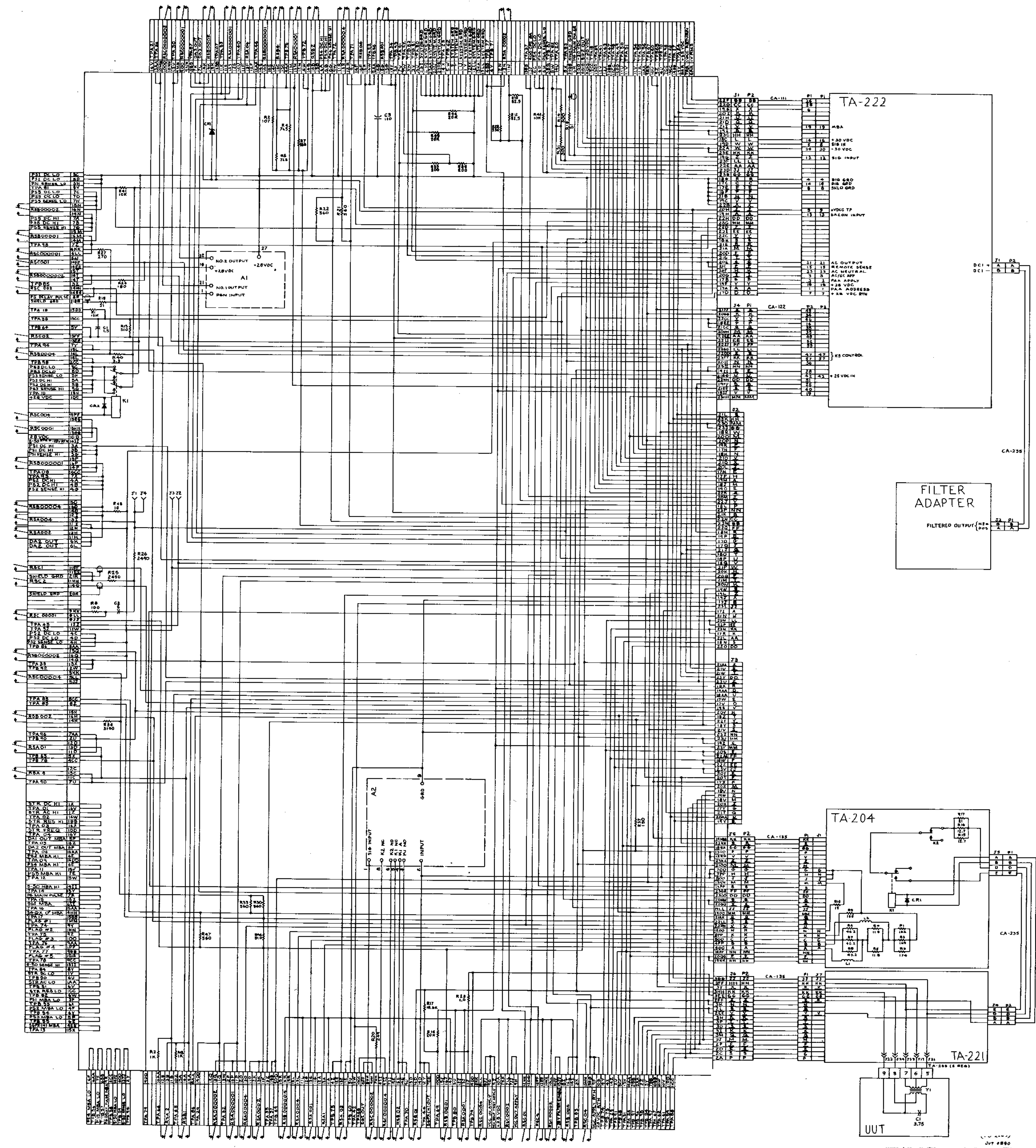

Figure 4-50. UUT 0890. Output Transformer Module Interconnection Diagram.

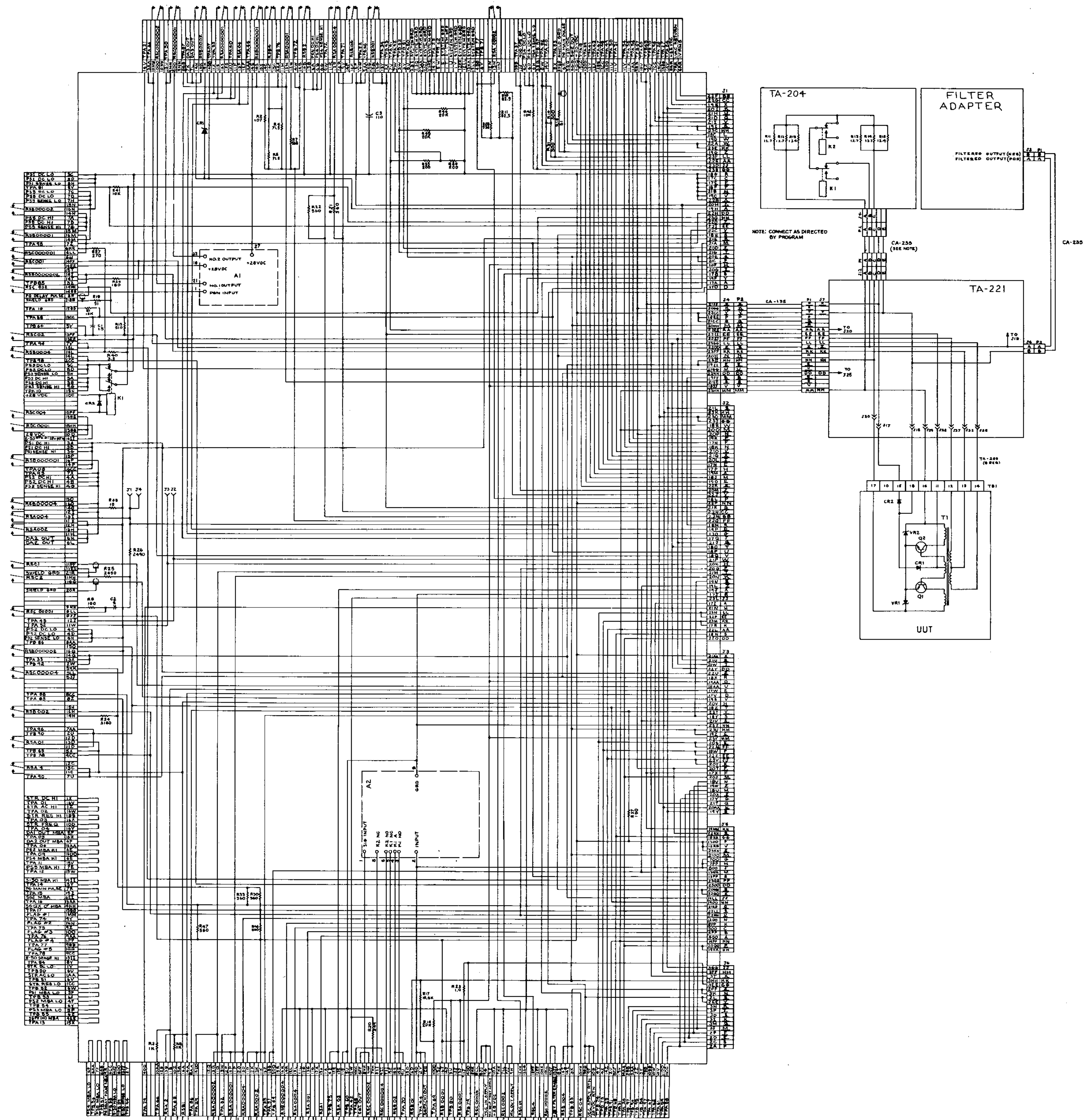
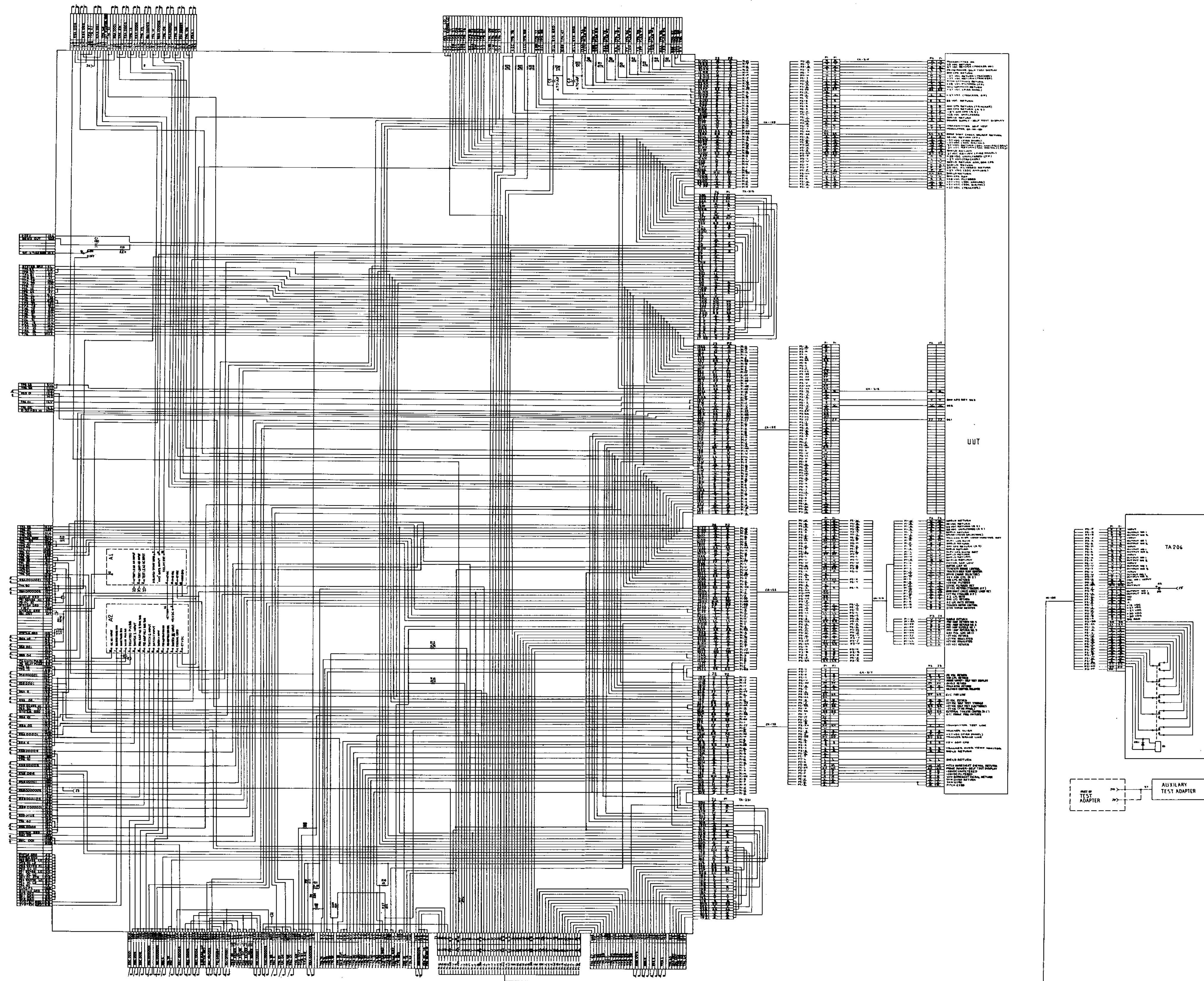

Figure 4-51. UUT 0920, Power Transistor Module Interconnection Diagram.



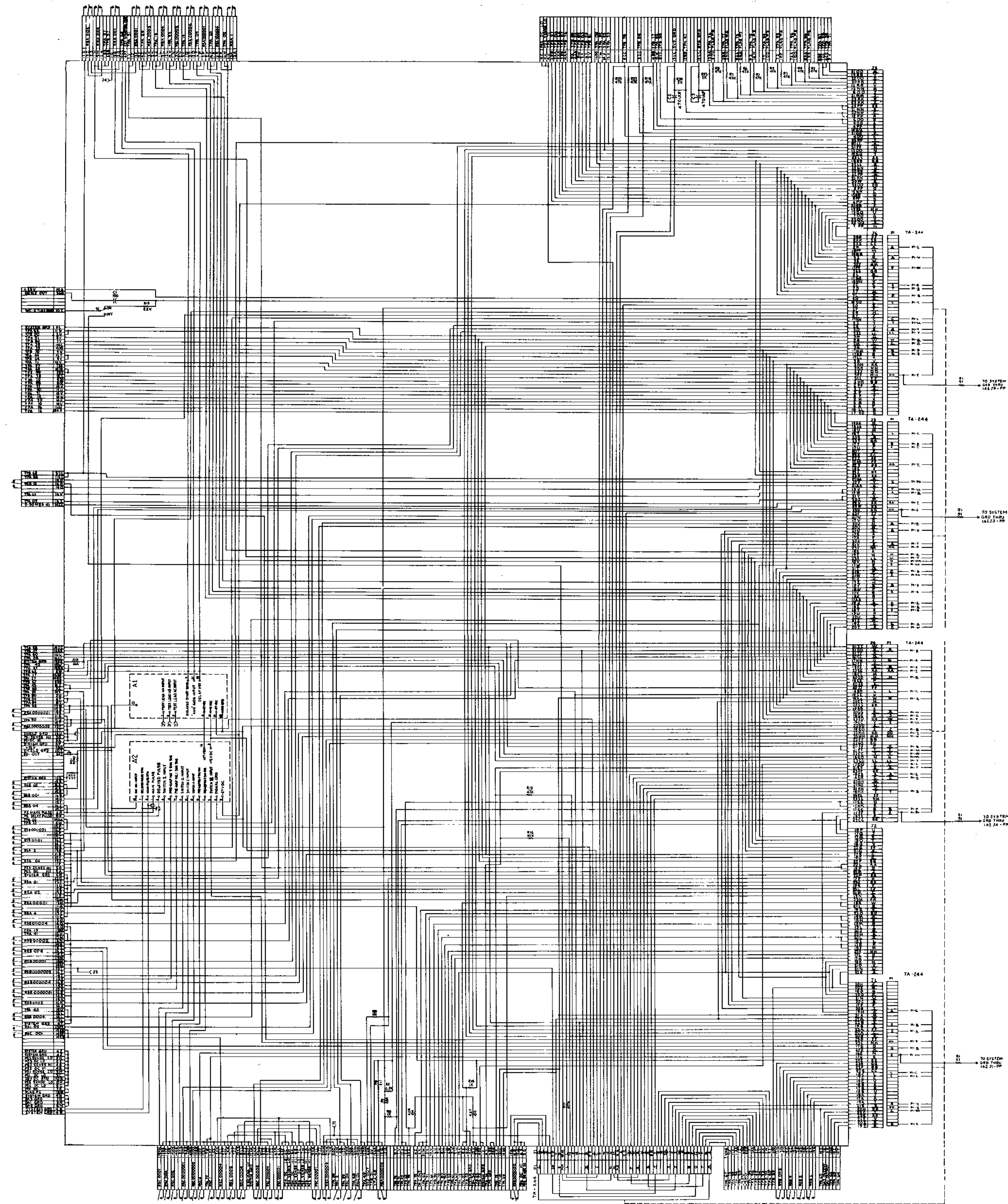

Figure 4-53. UUT 1500, Signal Data Converter Assembly (Survey Hook-Up) Interconnection Diagram.

C1

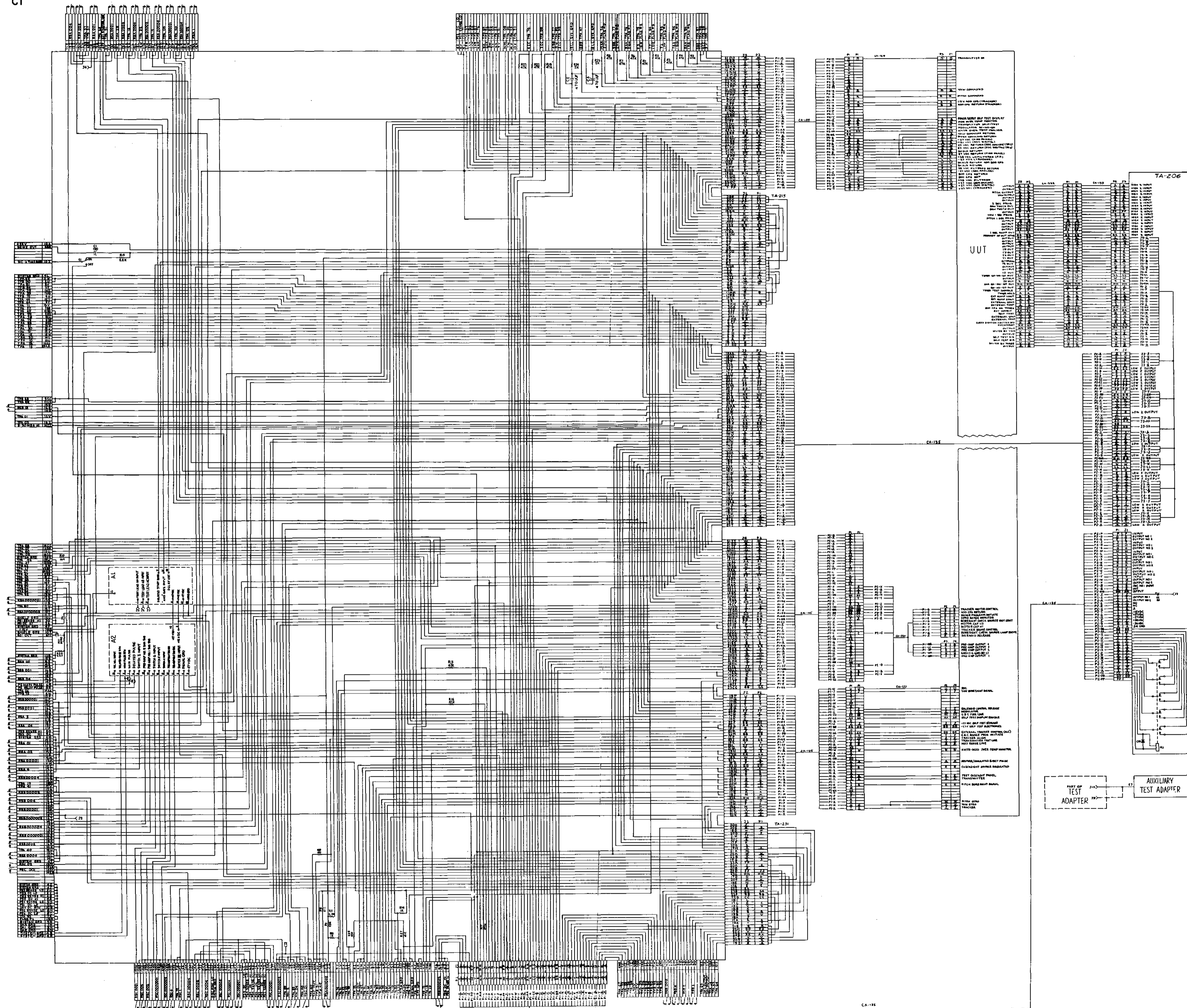

Figure 4-54. UUT 1500, Signal Data Converter Assembly (Dynamic Hook-Up) Interconnection Diagram.

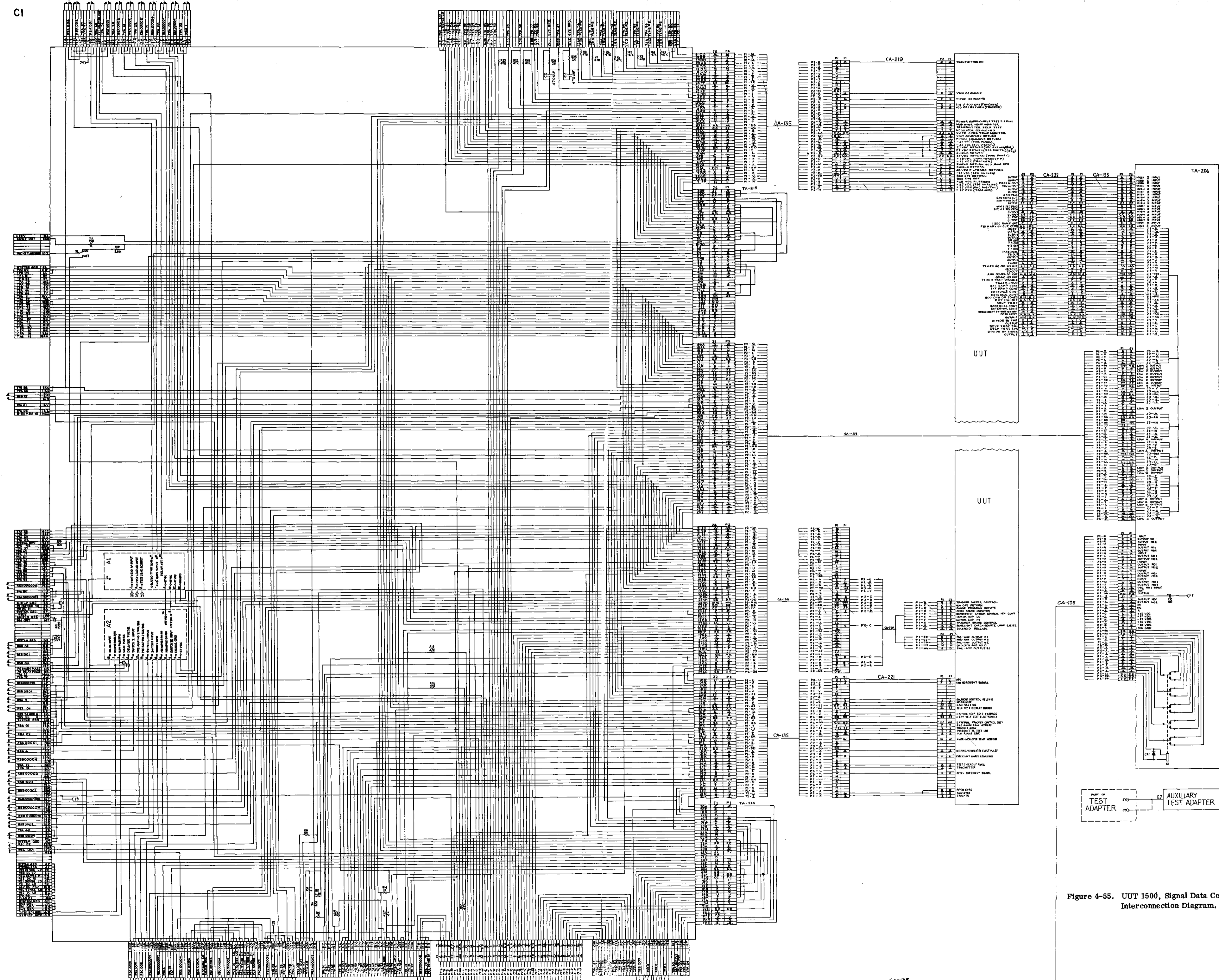

Figure 4-55. UUT 1500, Signal Data Converter Assembly (Go-Chain Cable Change 1) Interconnection Diagram.

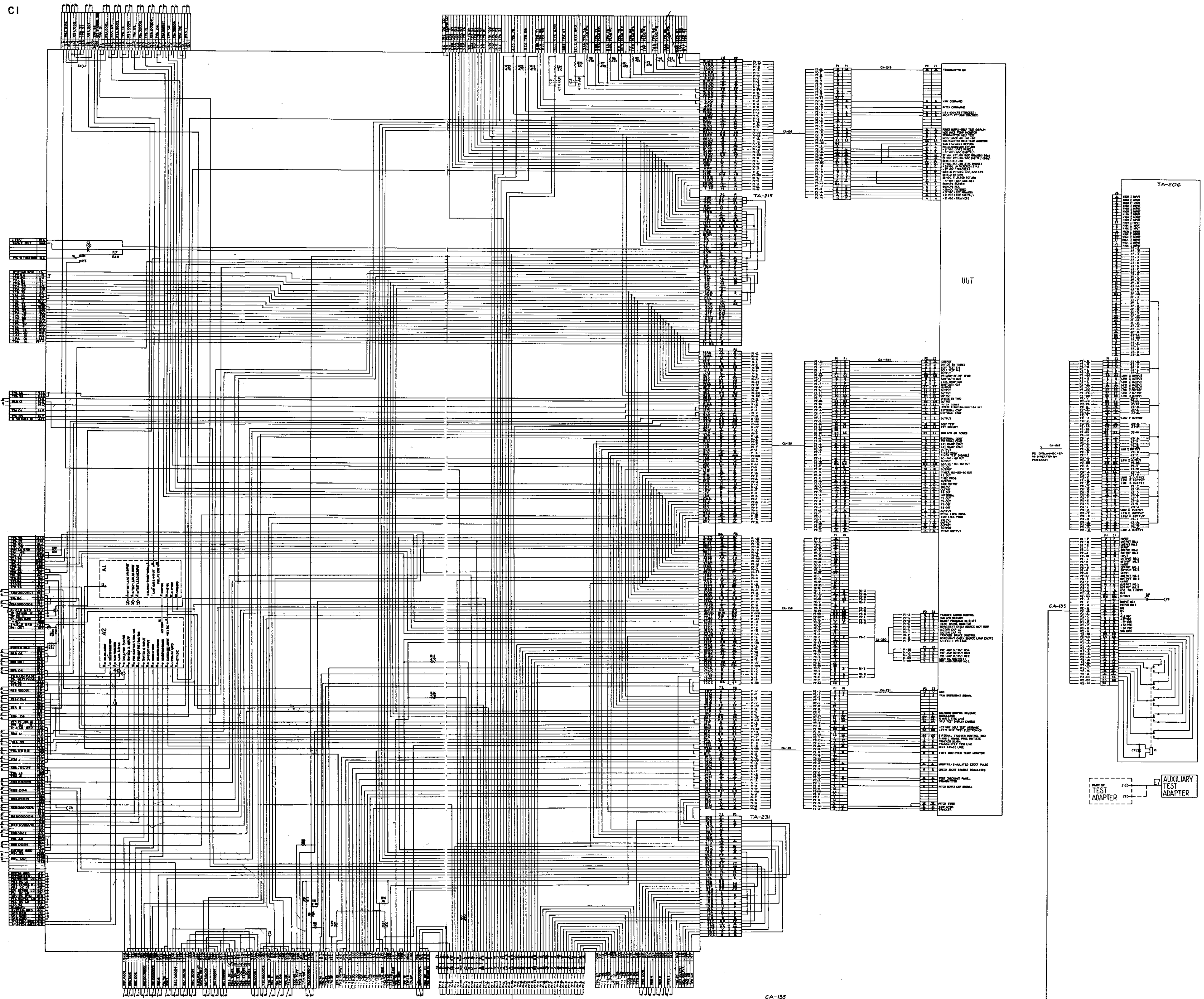

Figure 4-56. UUT 1500, Signal Data Converter Assembly (Go-Chain Cable Change 2) Interconnection Diagram.

Section I. UTILIZING MULTILAYER TYPE PATCHBOARDS

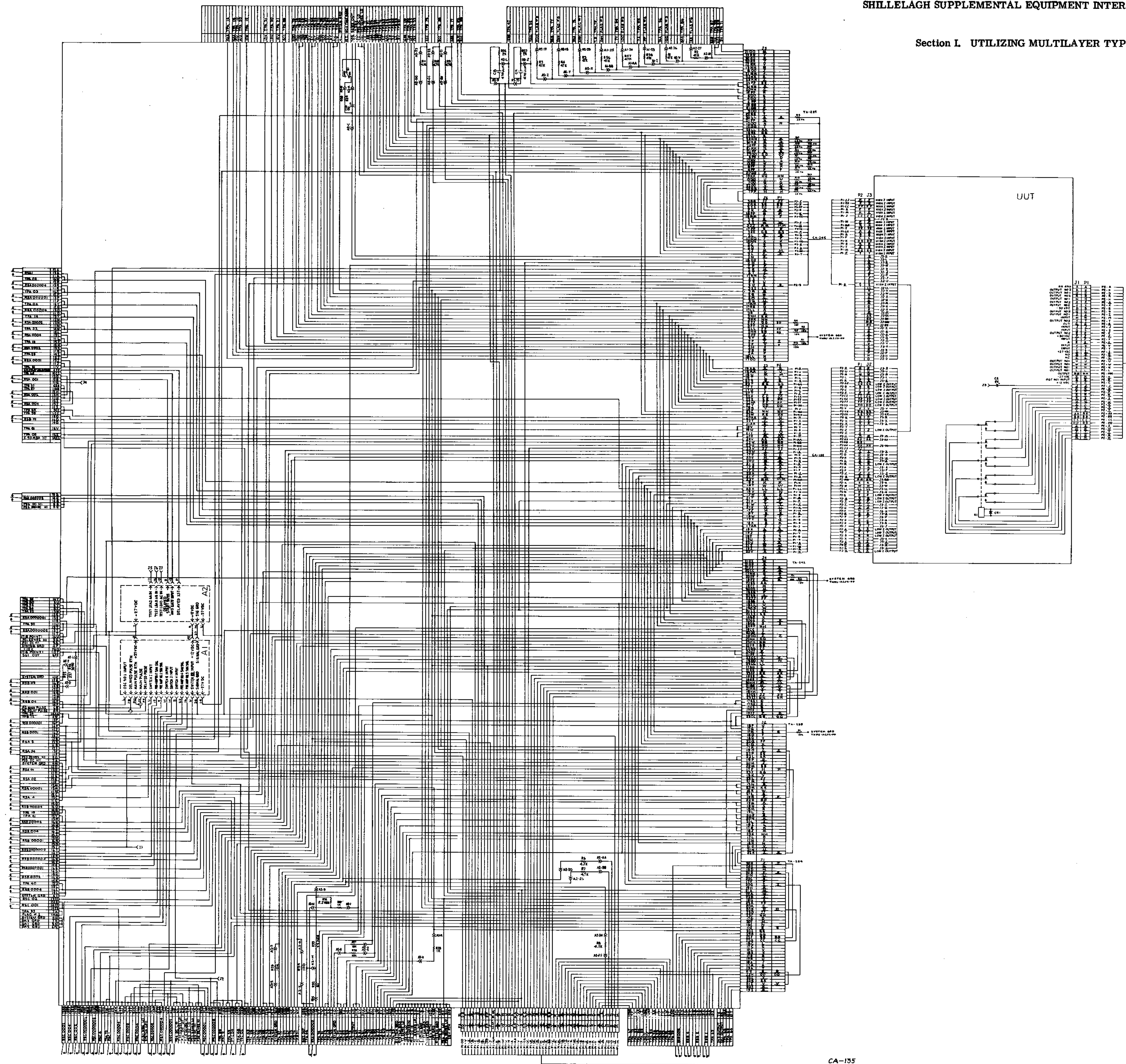

Figure 5-1. UUT 9630, Signal Conditioner Interconnection Diagram.



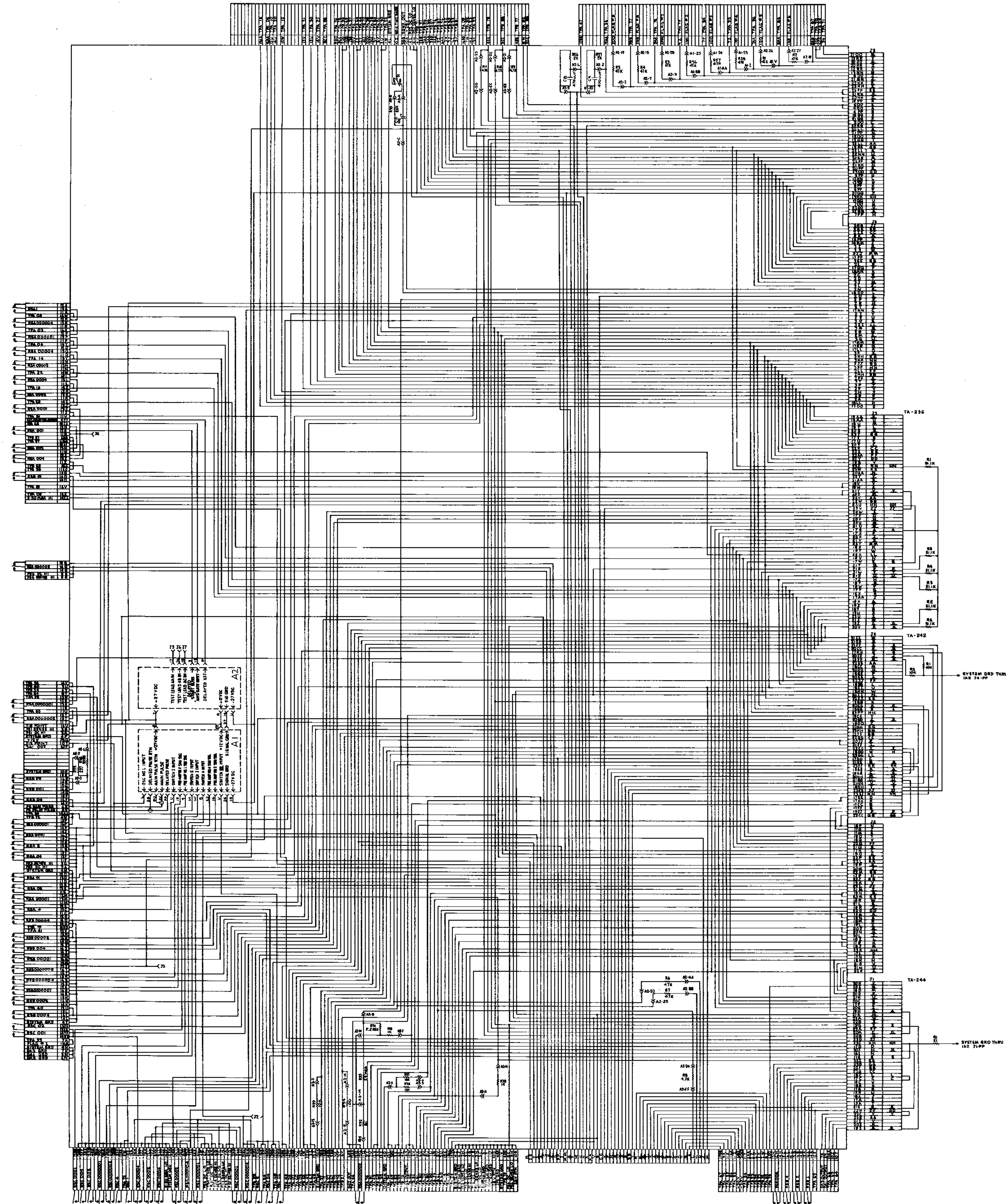

Figure 5-2. UUT 9630, Signal Conditioner (Survey Hook-Up) Interconnection Diagram.

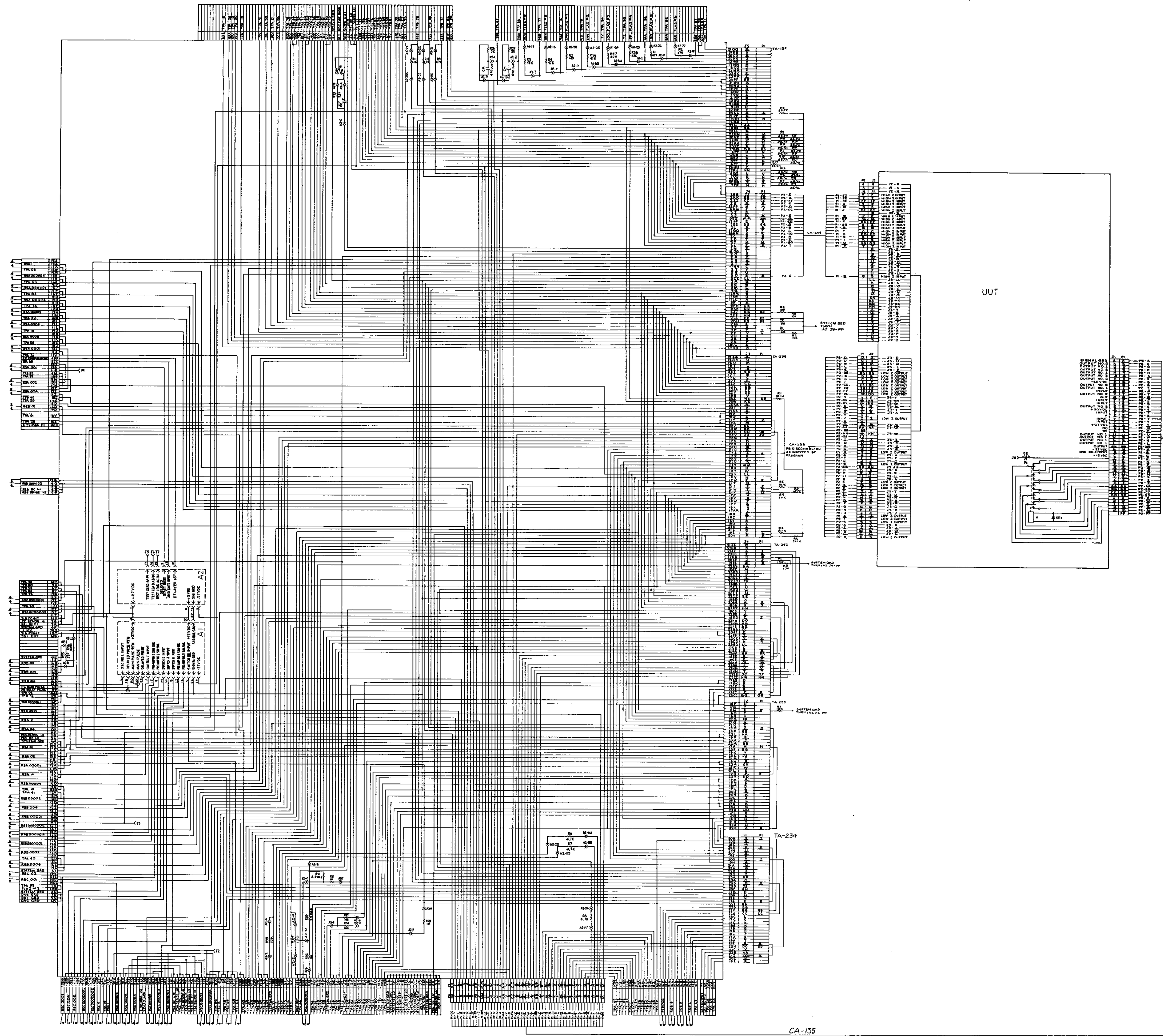

Figure 5-3. UUT 9630, Signal Conditioner (Go-Chain Cable Change) Interconnection Diagram.

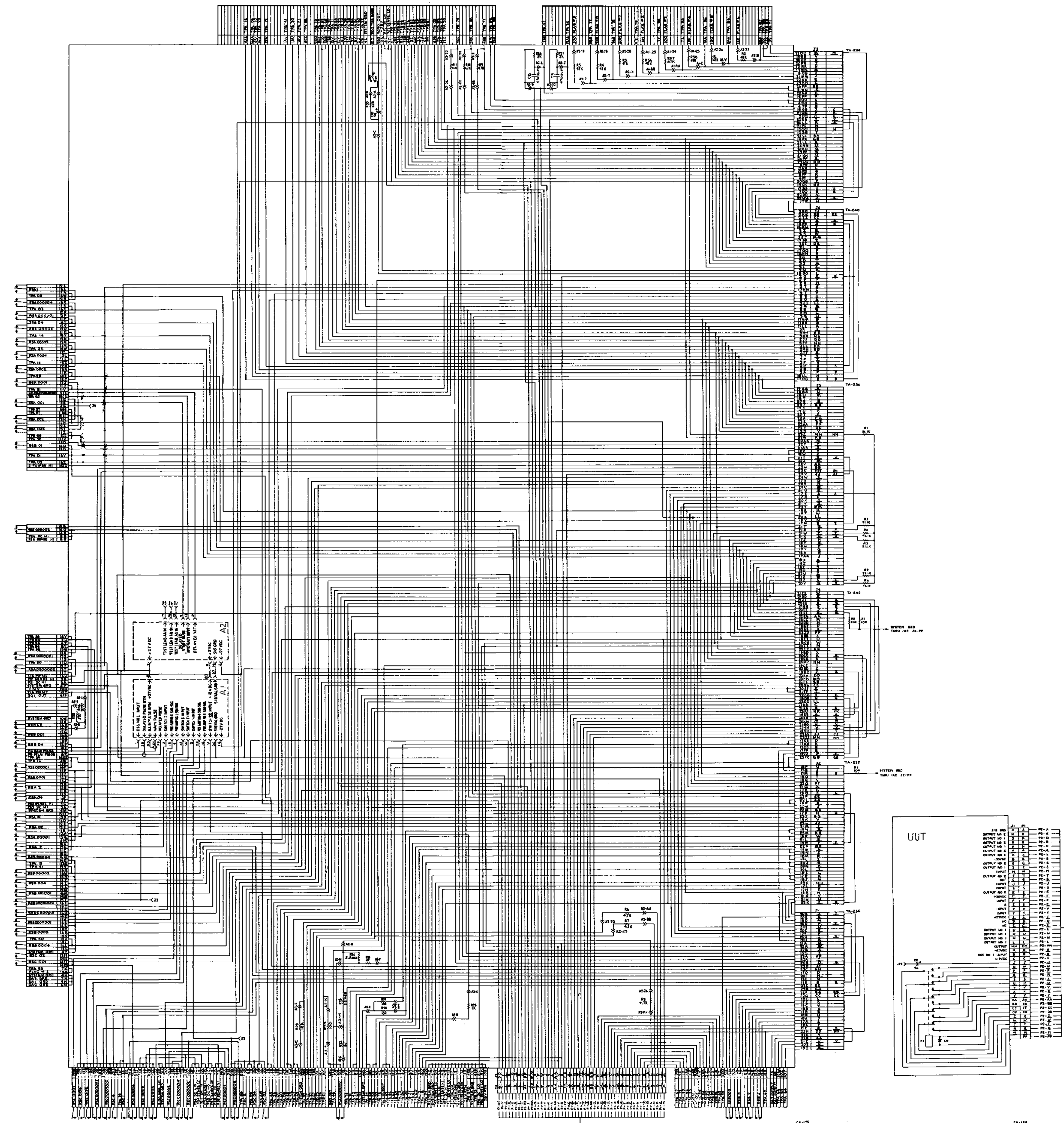

Figure 5-4. UUT 9630, Signal Conditioner (Static Hook-Up) Interconnection Diagram.

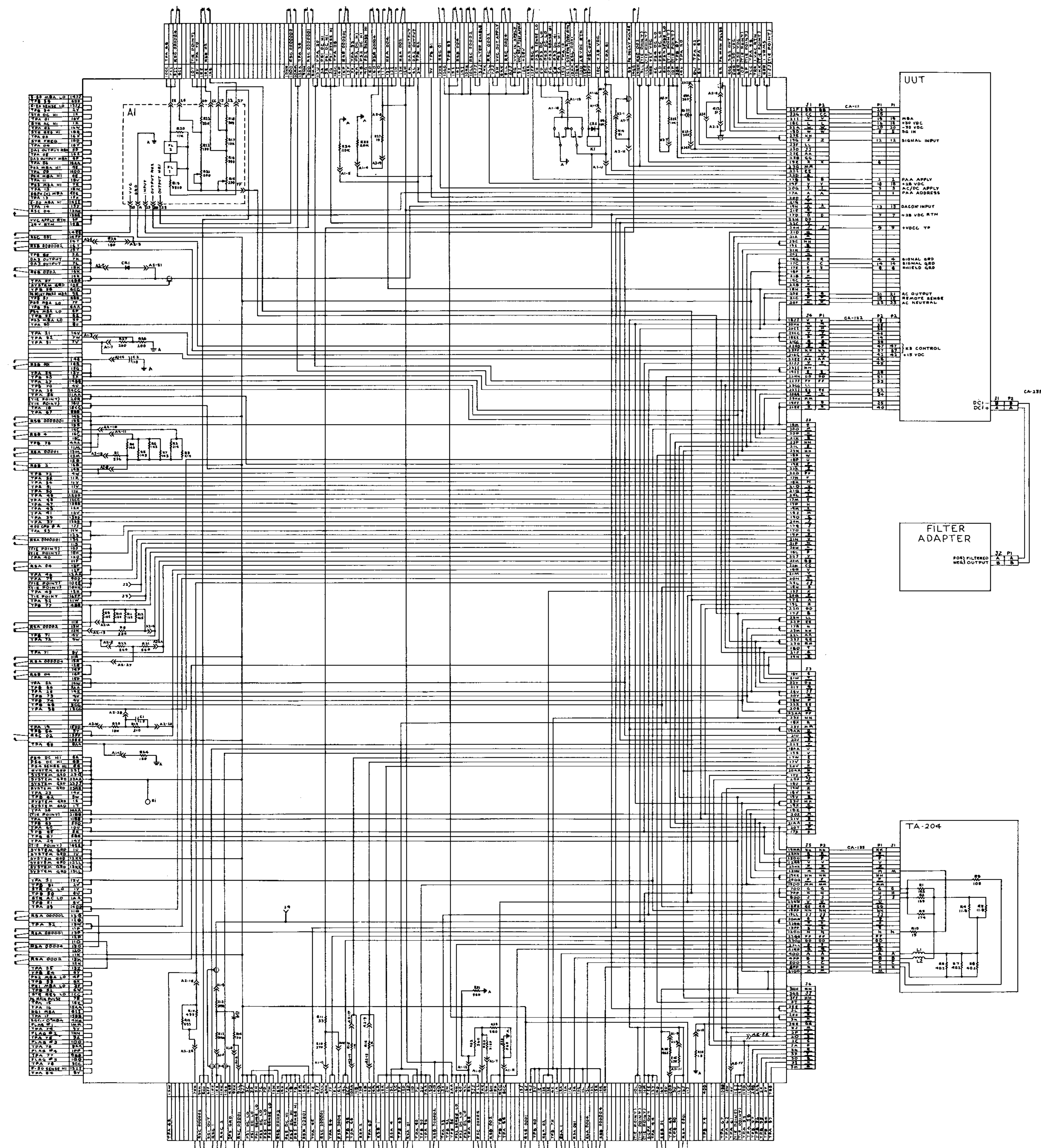

Figure 5-5. UUT 9640, AC Power Supply/Signal Conditioner Interconnection Diagram.

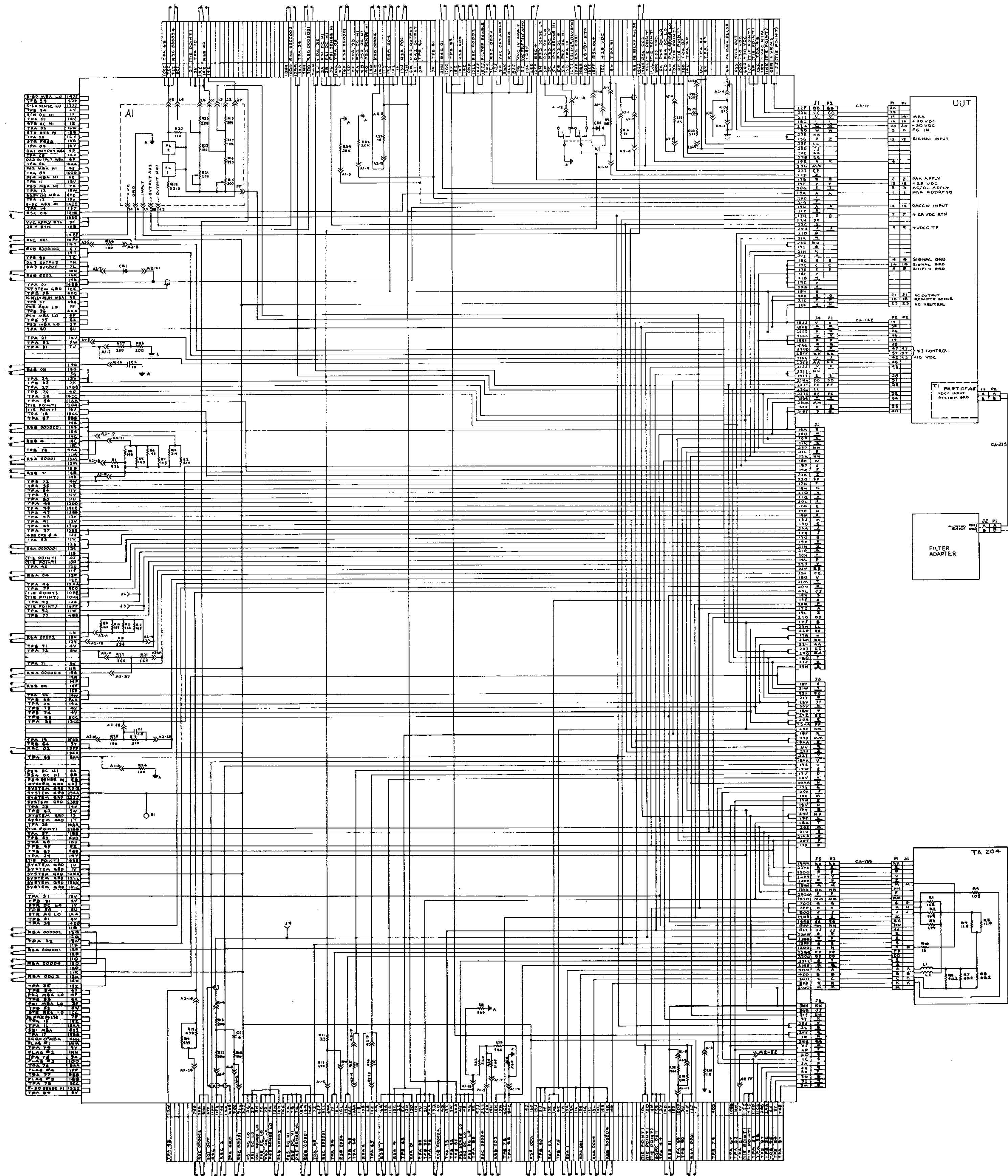

Figure 5-6. UUT 9640, AC Power Supply/Signal Conditioner (Go-Chain Cable Change) Interconnection Diagram.

Section II. UTILIZING SQUIB TYPE PATCHBOARDS

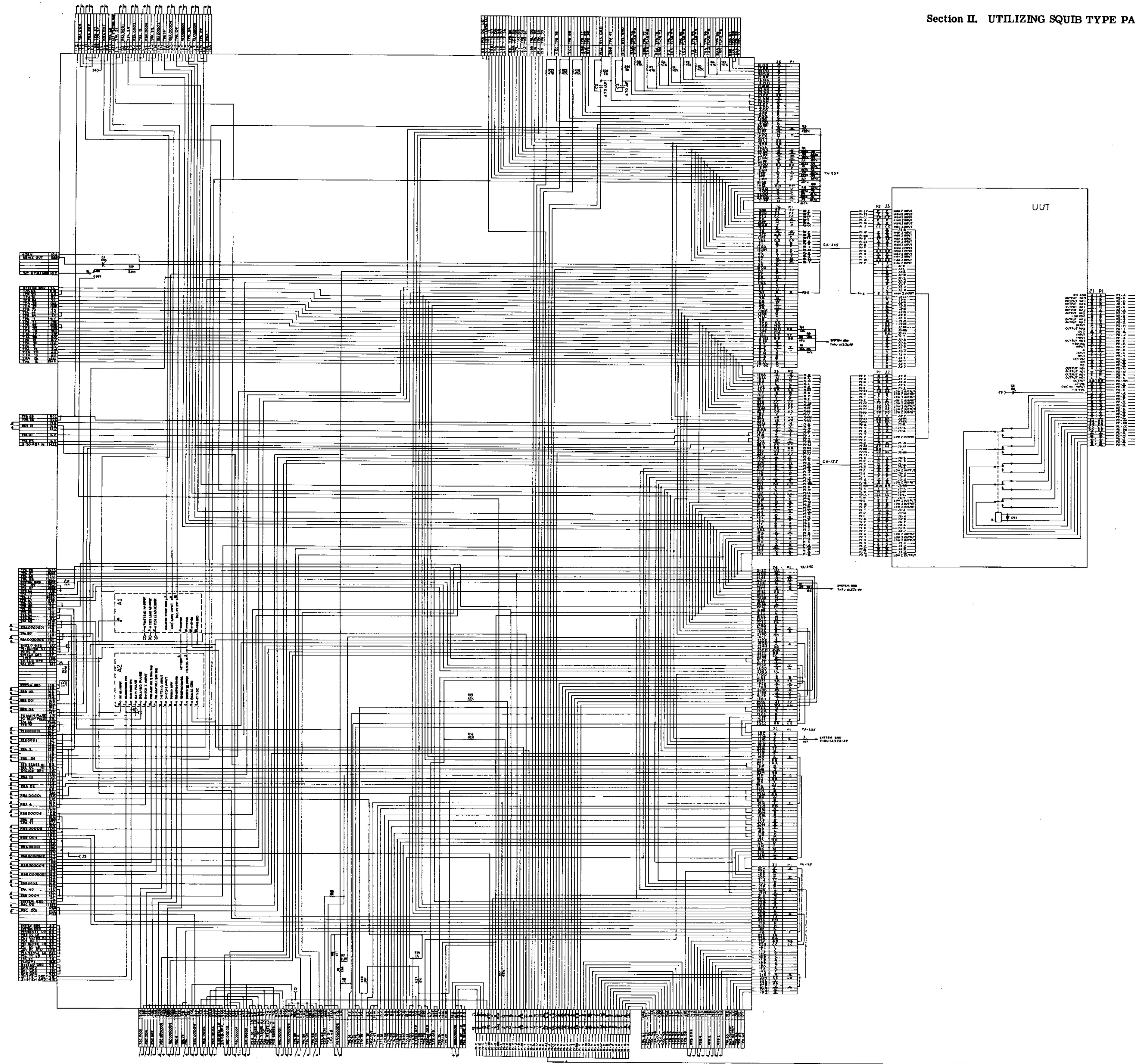

Figure 5-7. Utilizing Squib Type Patchboards UUT 9630, Signal Conditioner Interconnection Diagram.

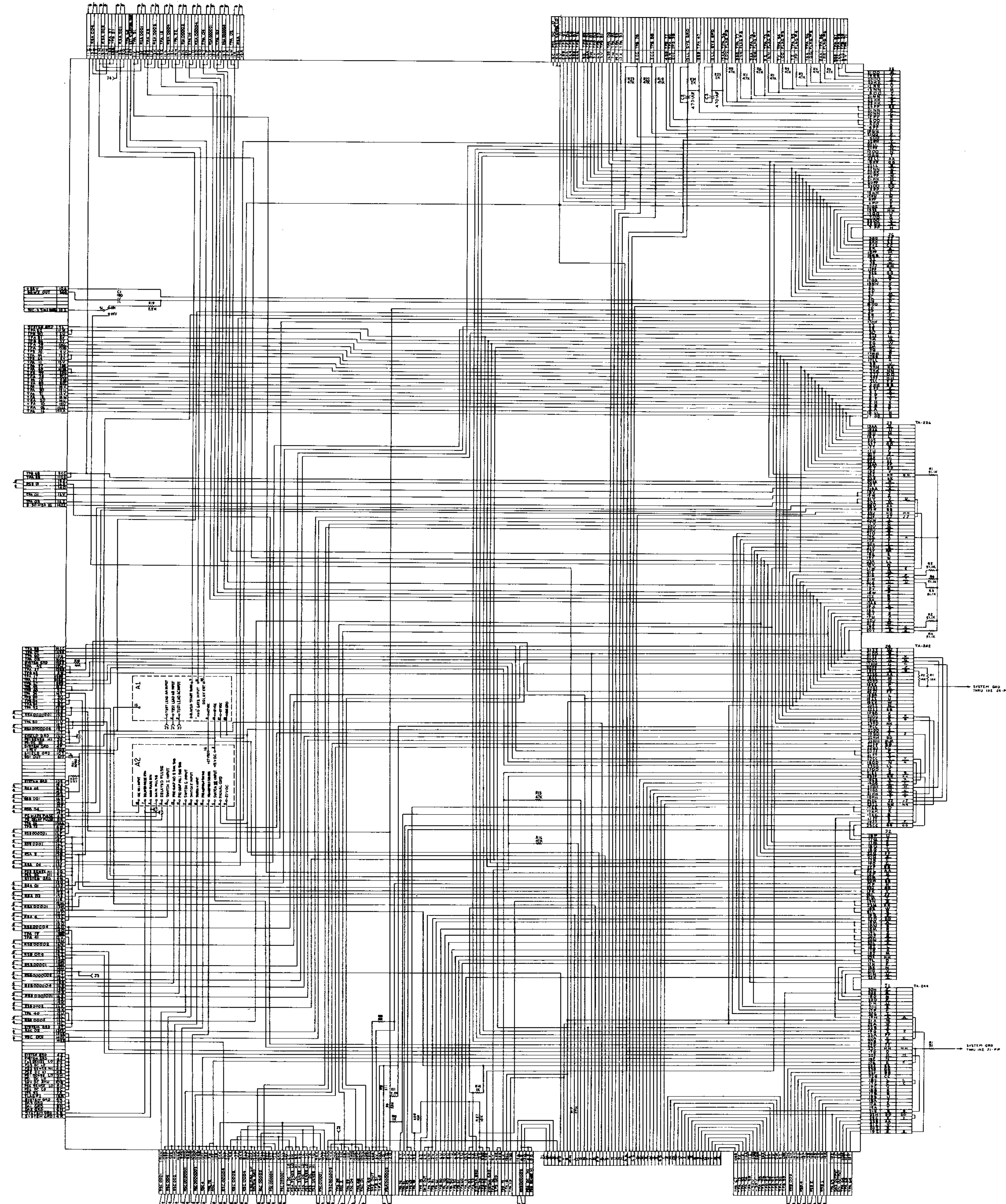

Figure 5-8. UUT 9630, Signal Conditioner (Survey Hook-Up) Interconnection Diagram.

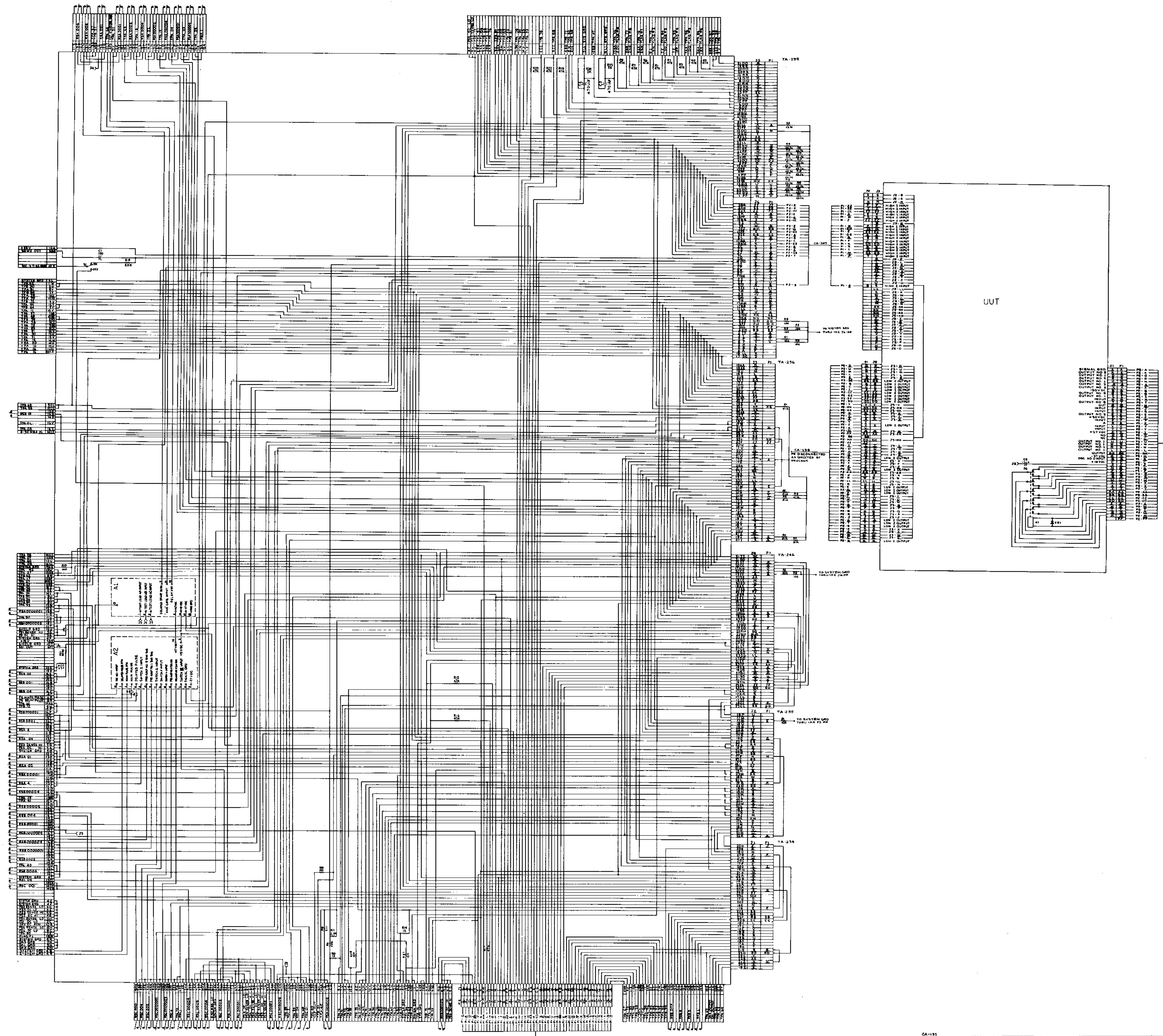

Figure 5-9. UUT 9630, Signal Conditioner (Go-Chain Cable Change) Interconnection Diagram.



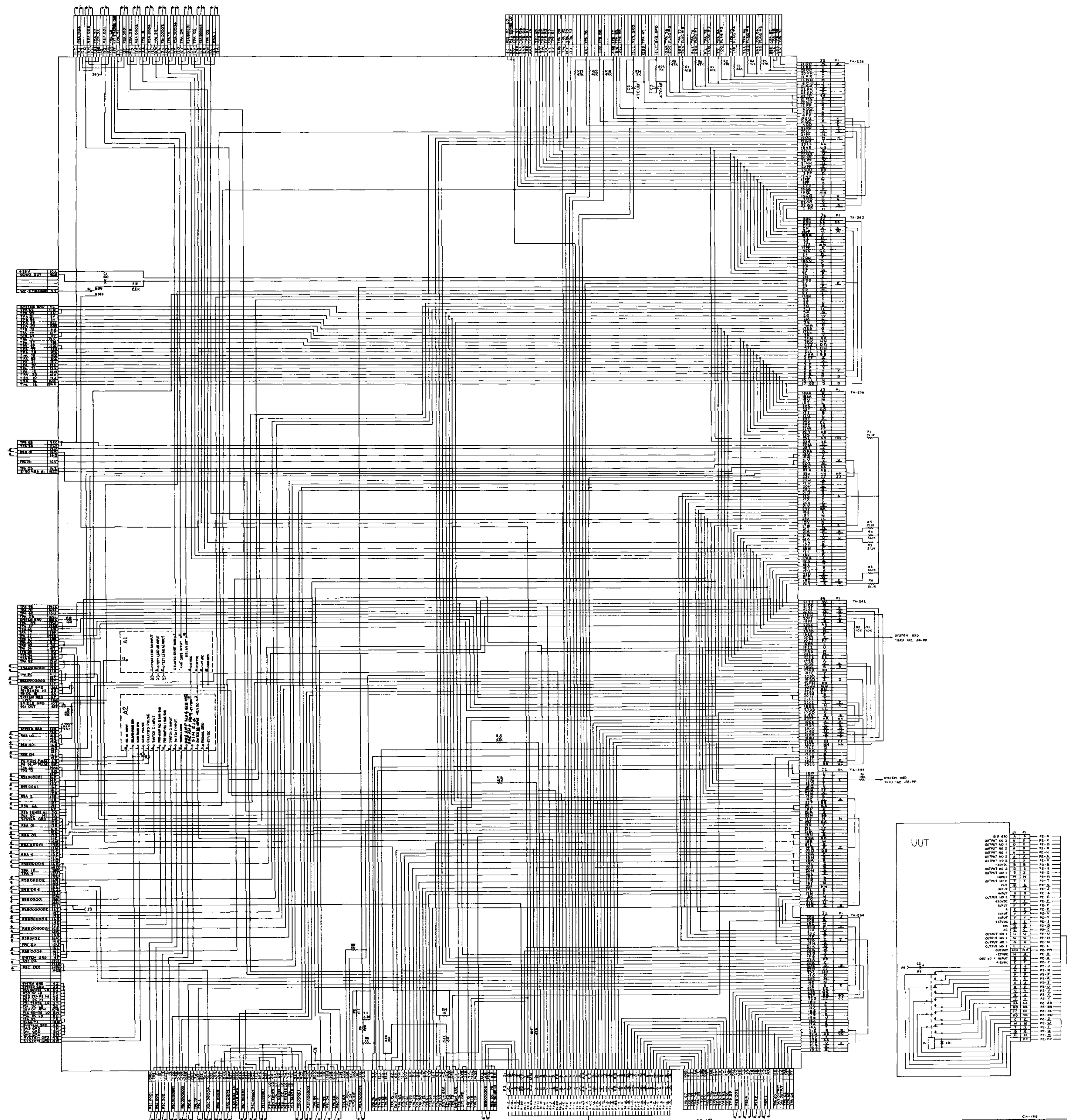

Figure 5-10. UUT 9630, Signal Conditioner (Static Hook-Up) Interconnection Diagram.

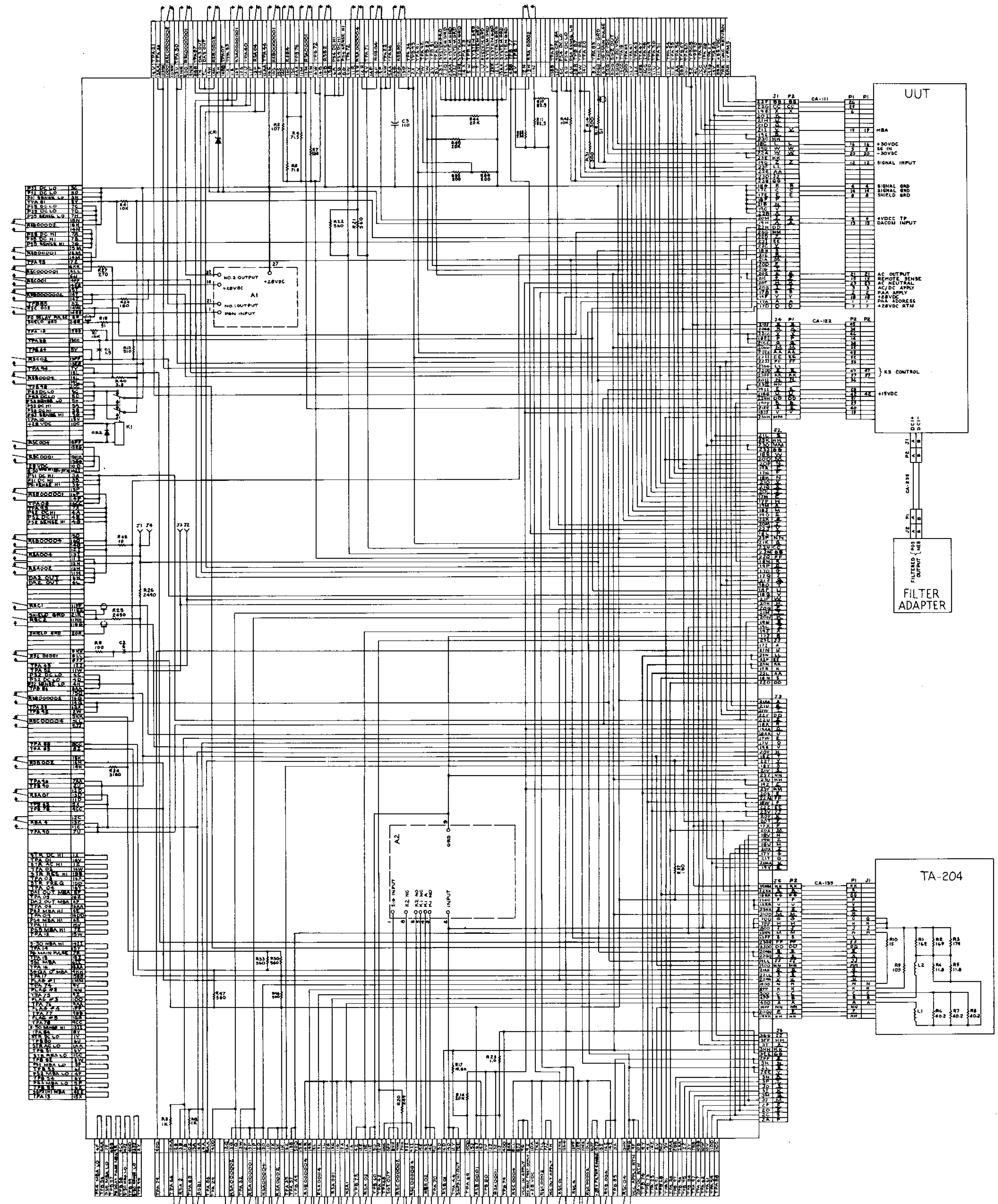
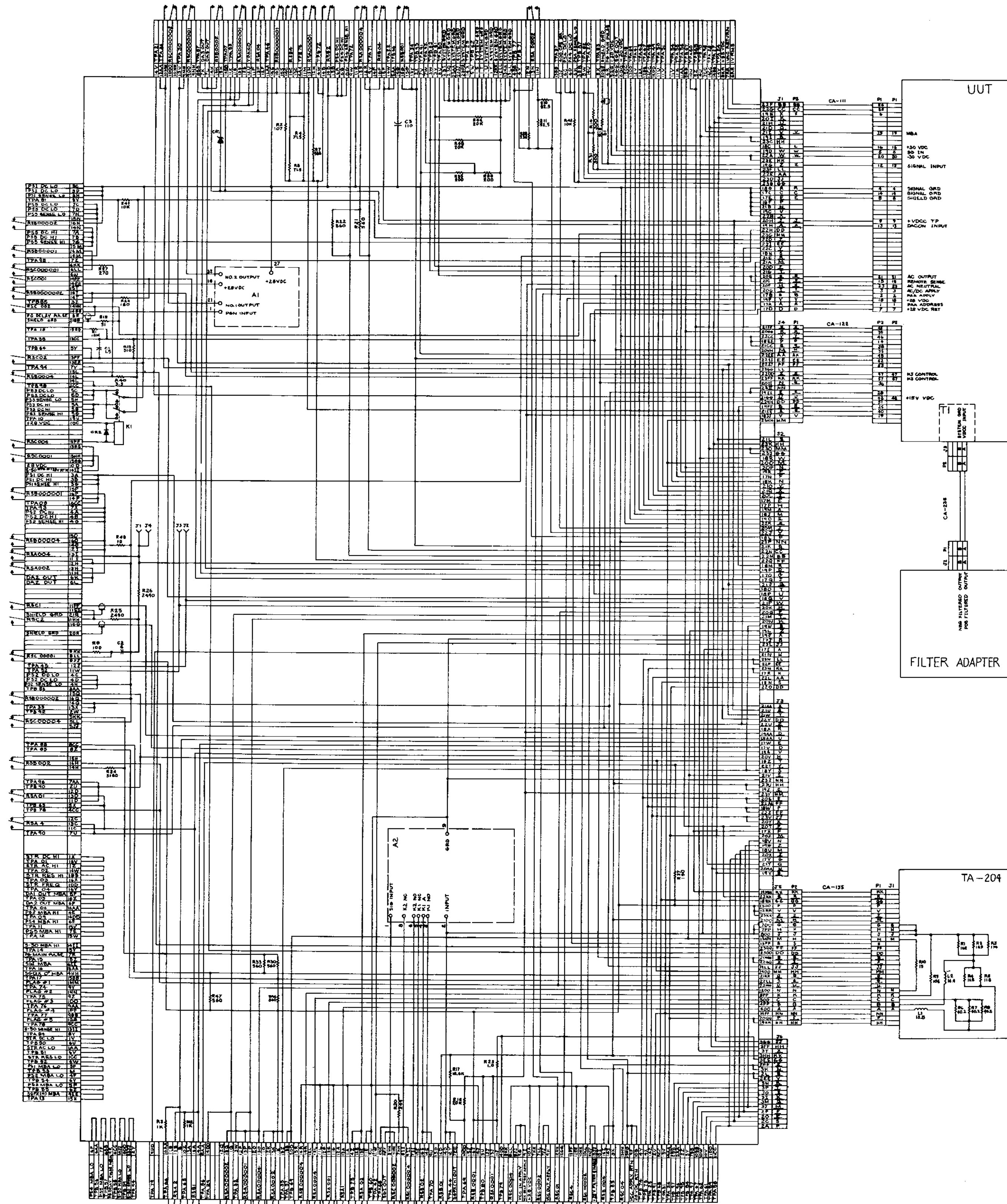

Figure 5-11. UUT 9640, AC Power Supply/Signal Conditioner Interconnection Diagram.



CHAPTER 6  
TOW INTERCONNECTION DIAGRAMS

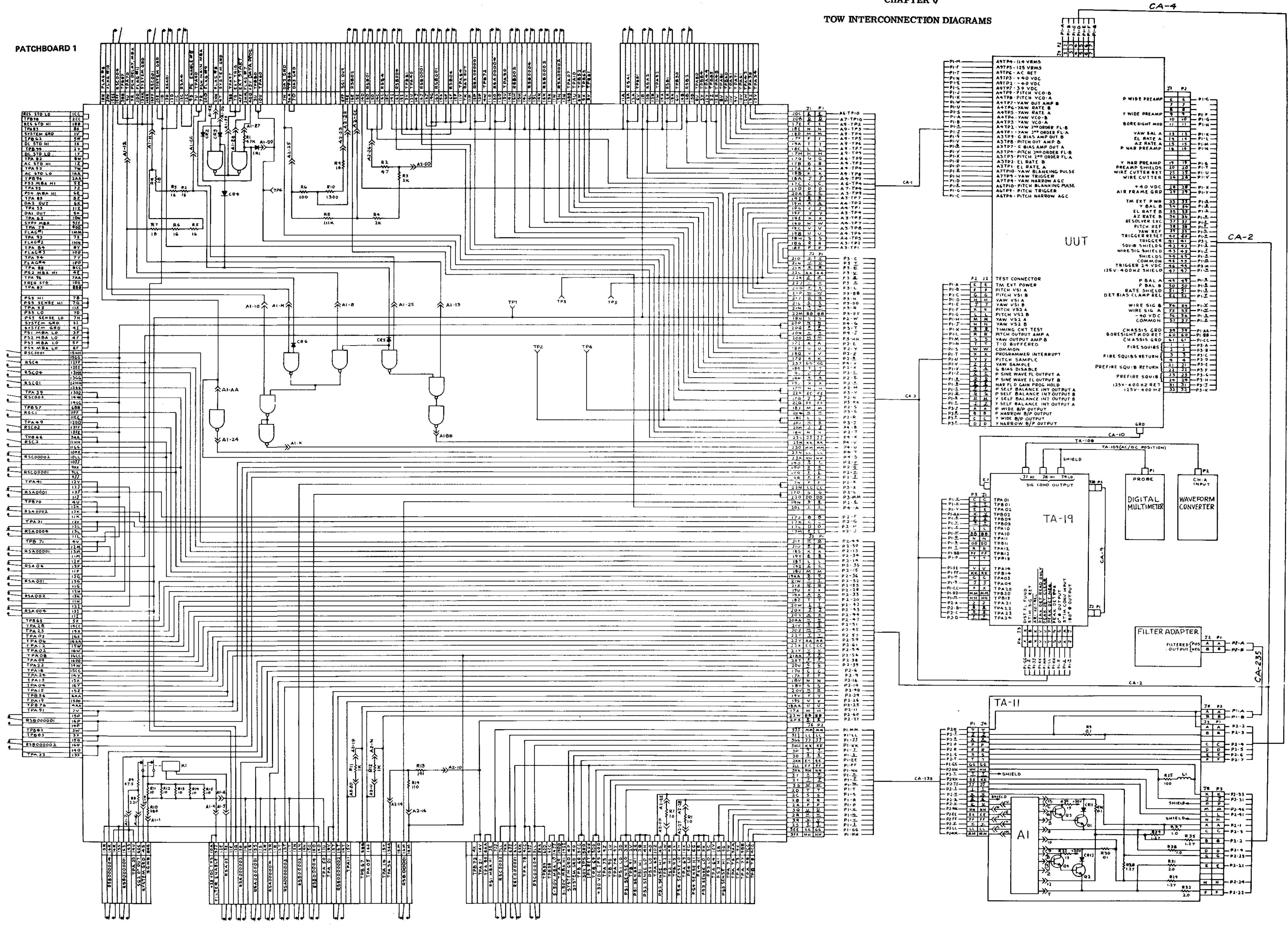

Figure 6-1. UUT 2100, Missile Guidance Set Interconnection Diagram.

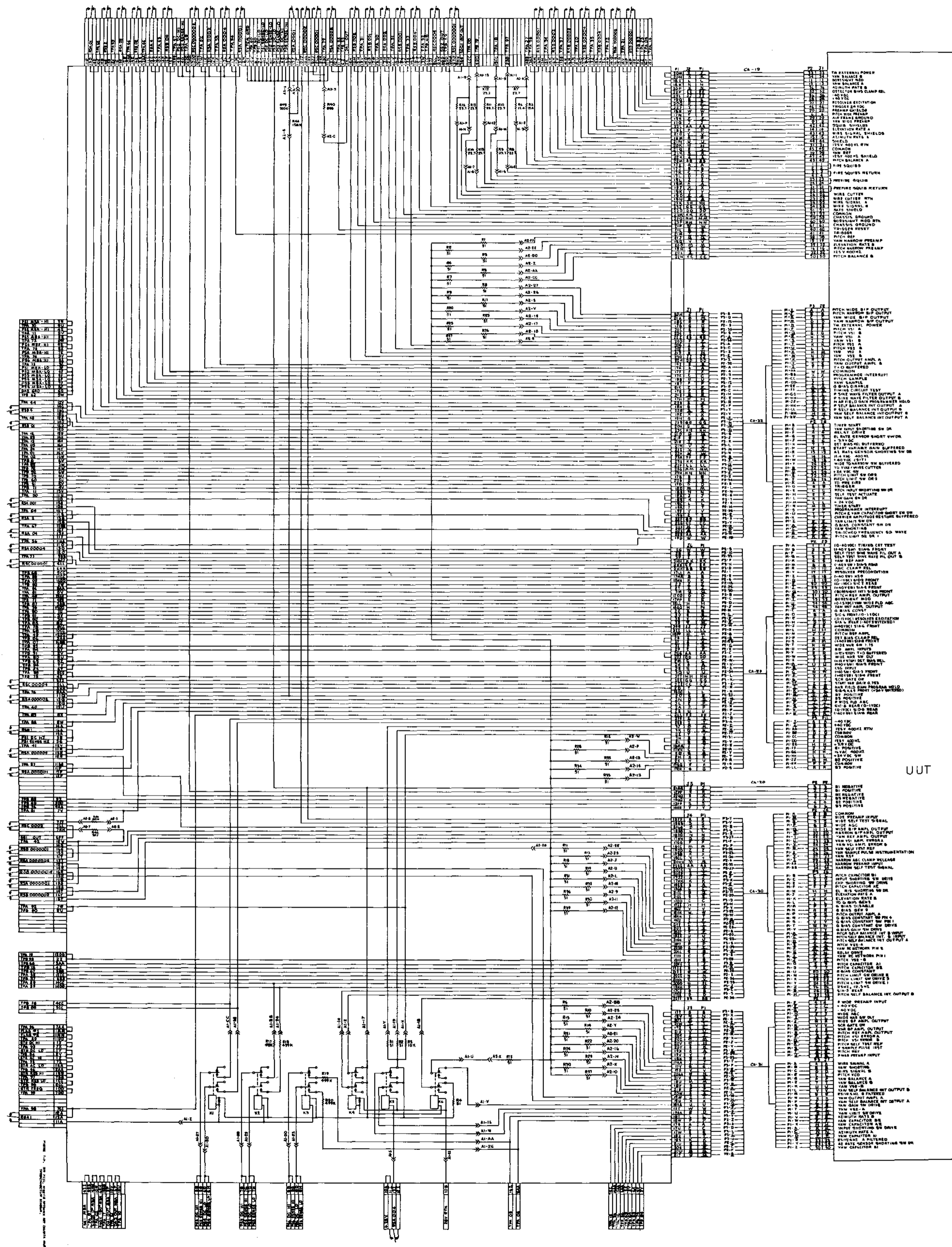

Figure 6-2. UUT 2110, Missile Guidance Set Chassis Assembly Interconnection Diagram.

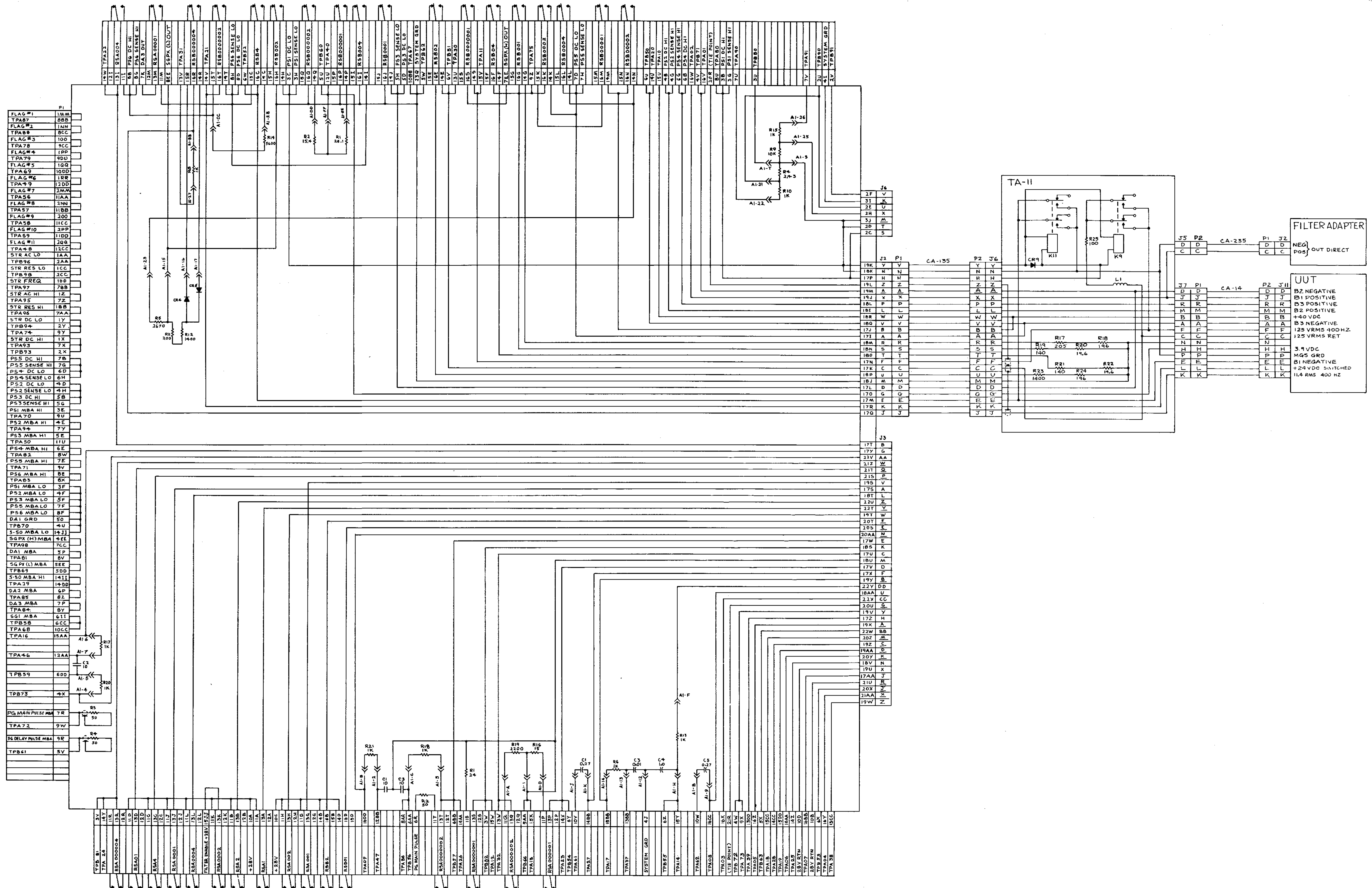

Figure 6-3. UUT 2120, Power Supply Assembly Interconnection Diagram.

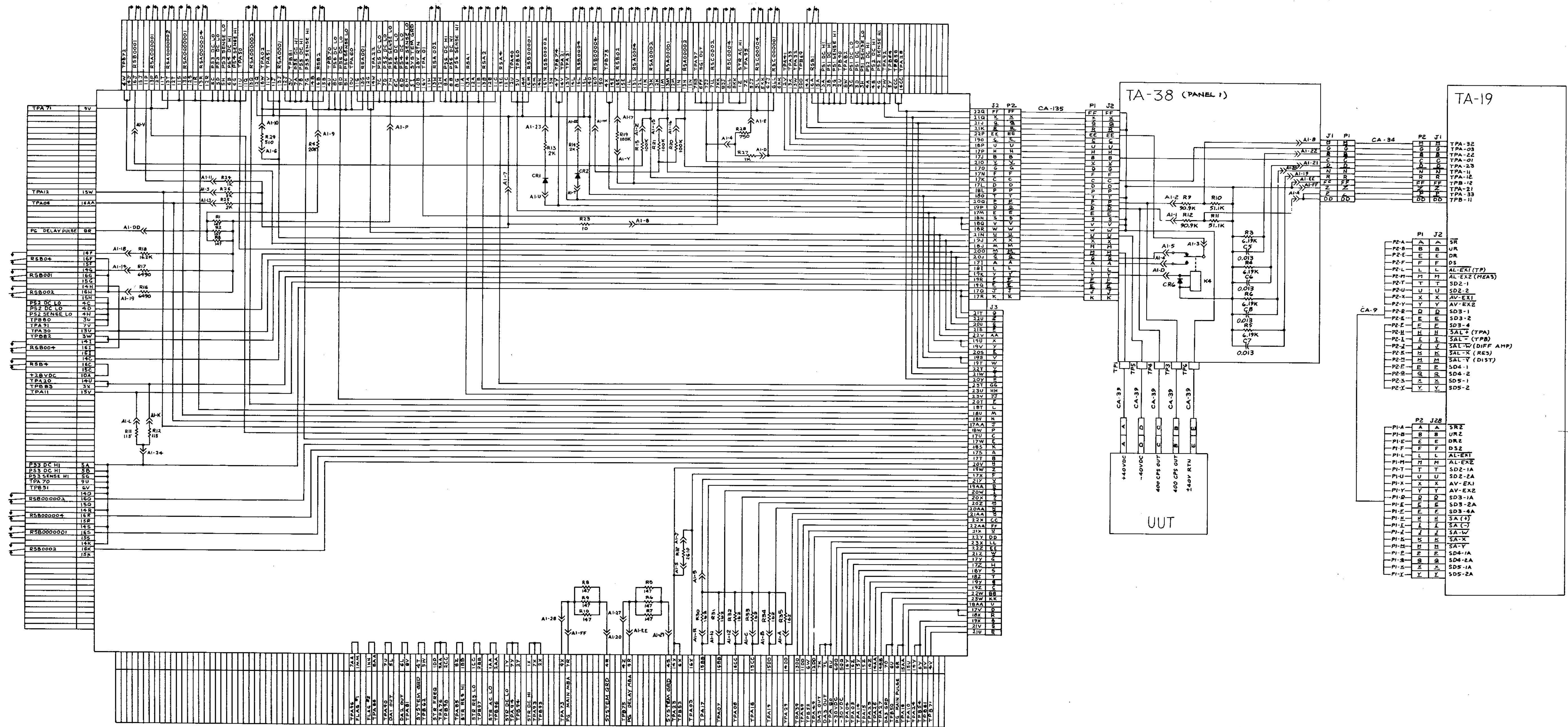

Figure 6-4. UUT 2121, 400 Hz Oscillator Circuit Card Interconnection Diagram.

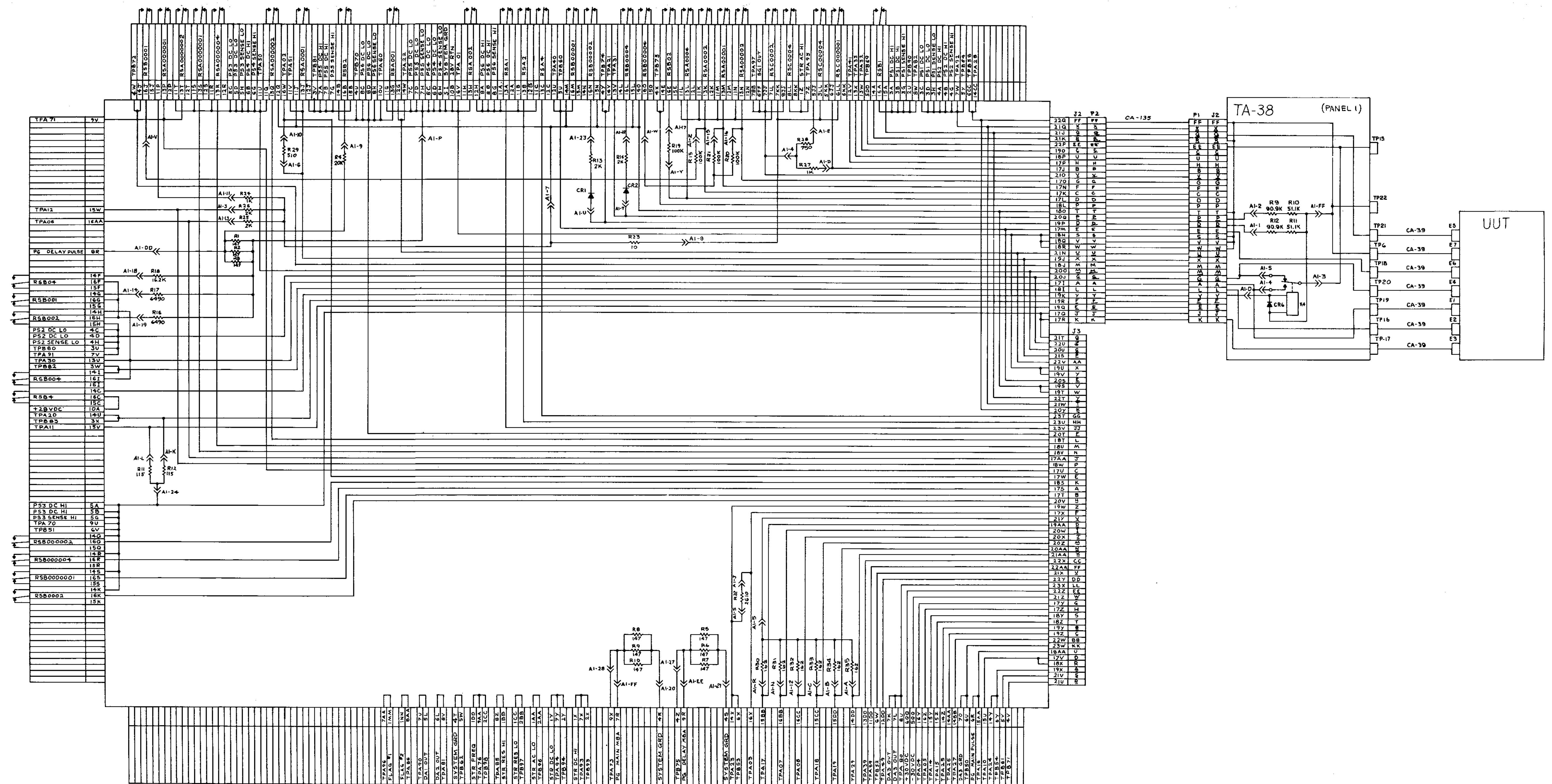

Figure 6-5. UUT 2122, DC Regulator Circuit Card Interconnection Diagram.



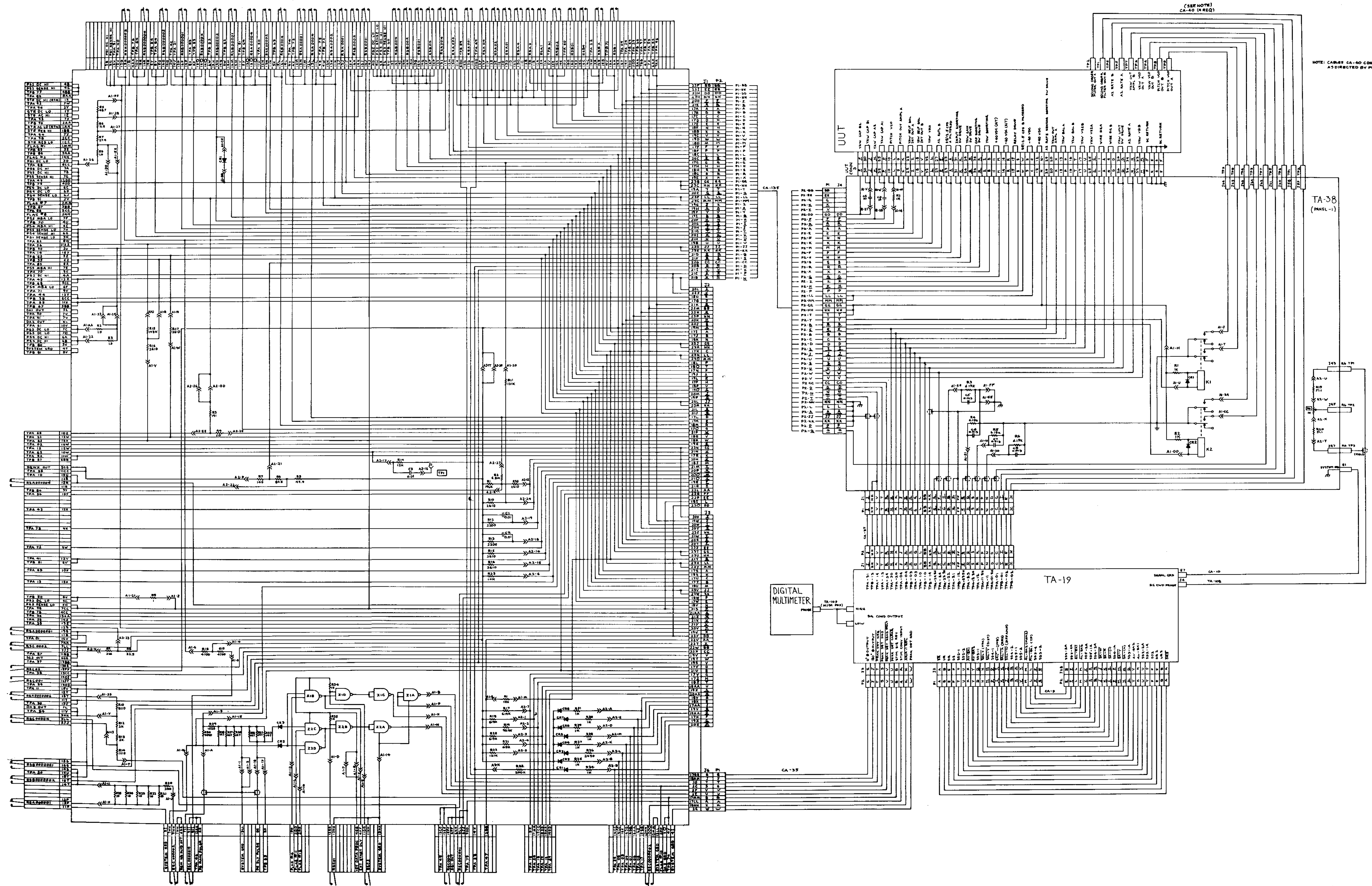

Figure 6-6. UUT 2130, Yaw Command Signal Generator Circuit Card Interconnection Diagram.

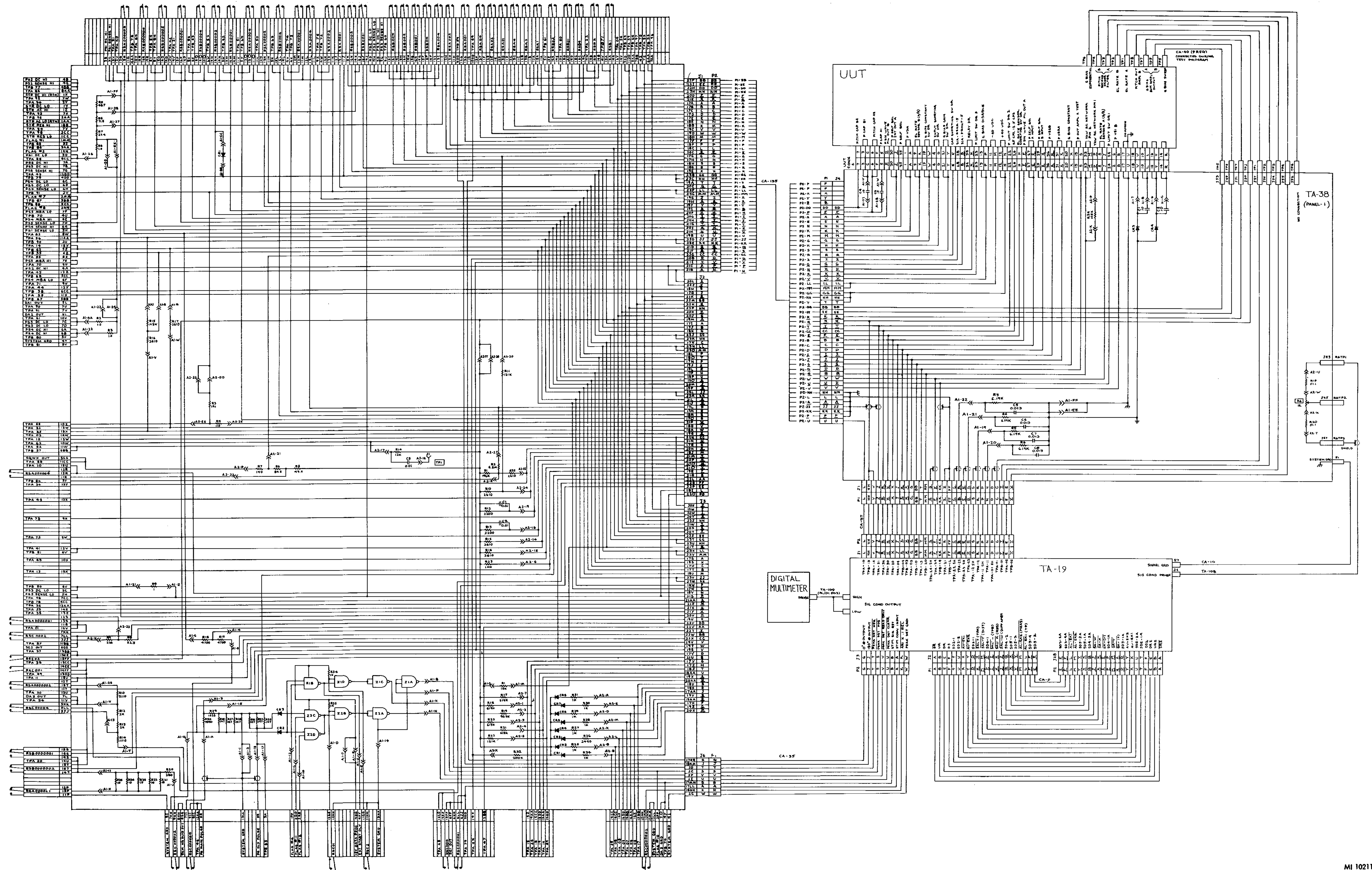
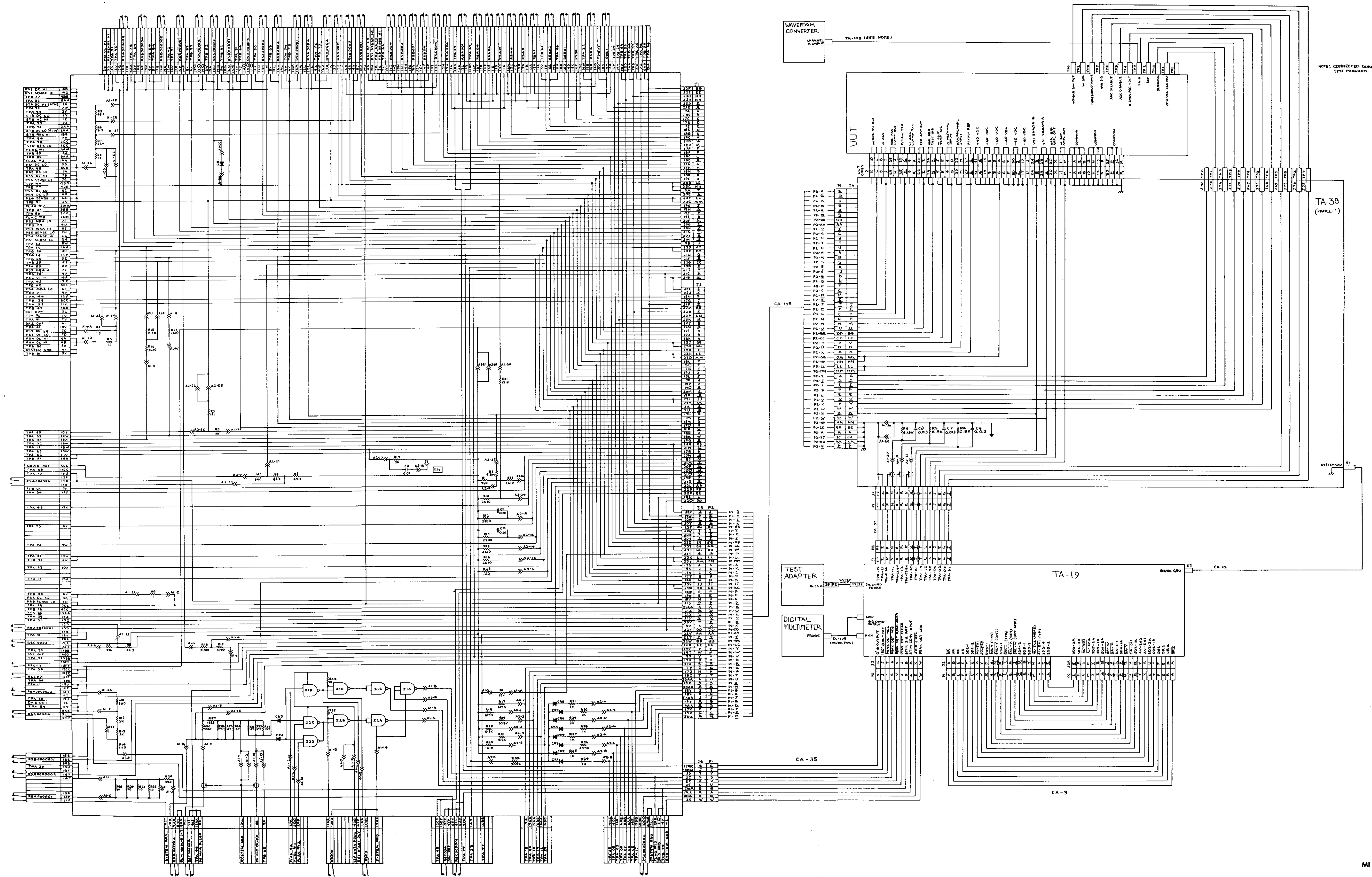

Figure 6-7. UUT 2150, Pitch Command Signal Generator Circuit Card Interconnection Diagram.

CA-40  
(11 REQ. SEE NOTE)



NOTE: CONNECTED DURING TEST PROGRAM

Figure 6-8. UUT 2170, Error Detector Circuit Card Interconnection Diagram.

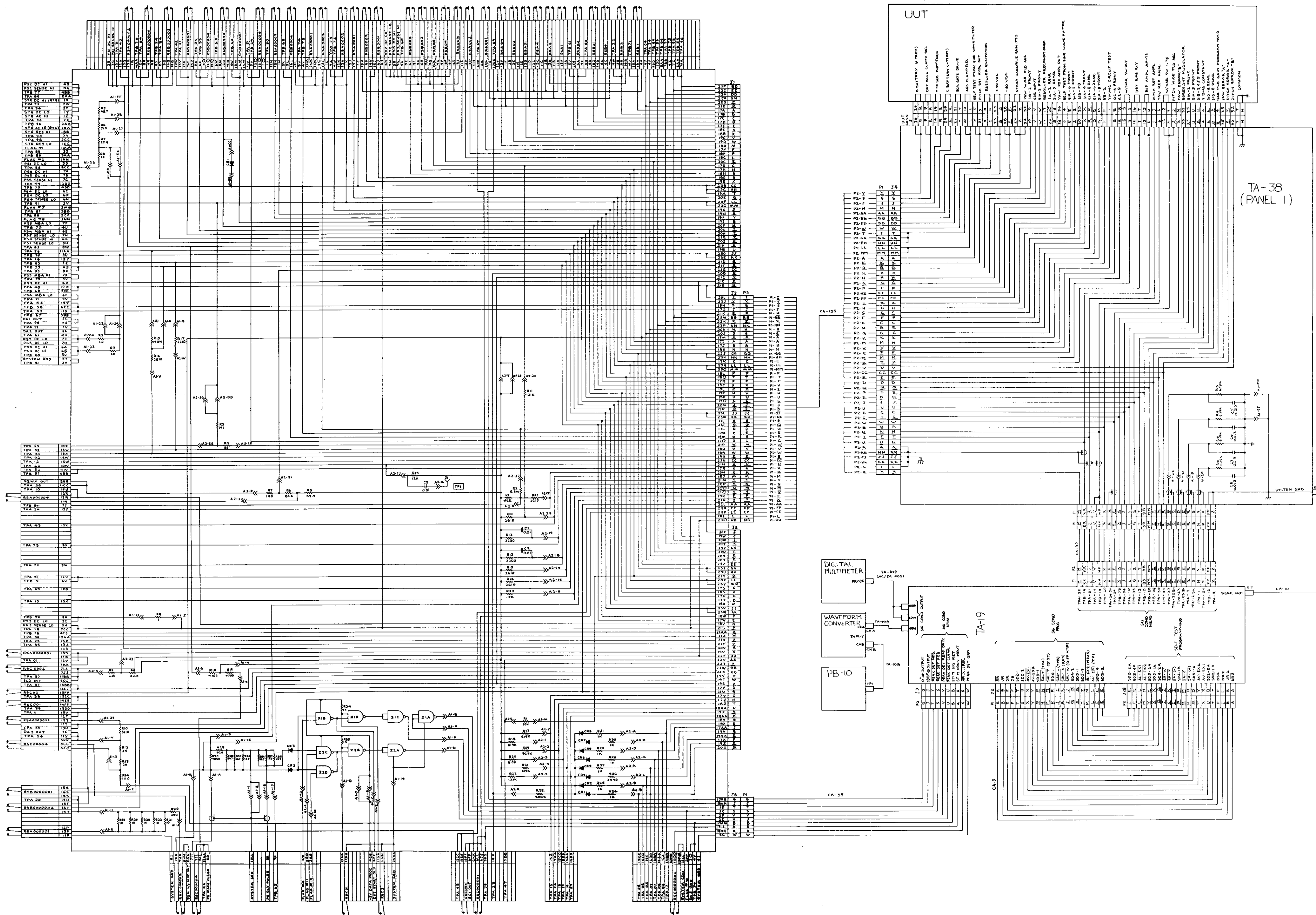

Figure 6-9. UUT 2210, Excitation Generator and Self Test Circuit Card Interconnection Diagram.

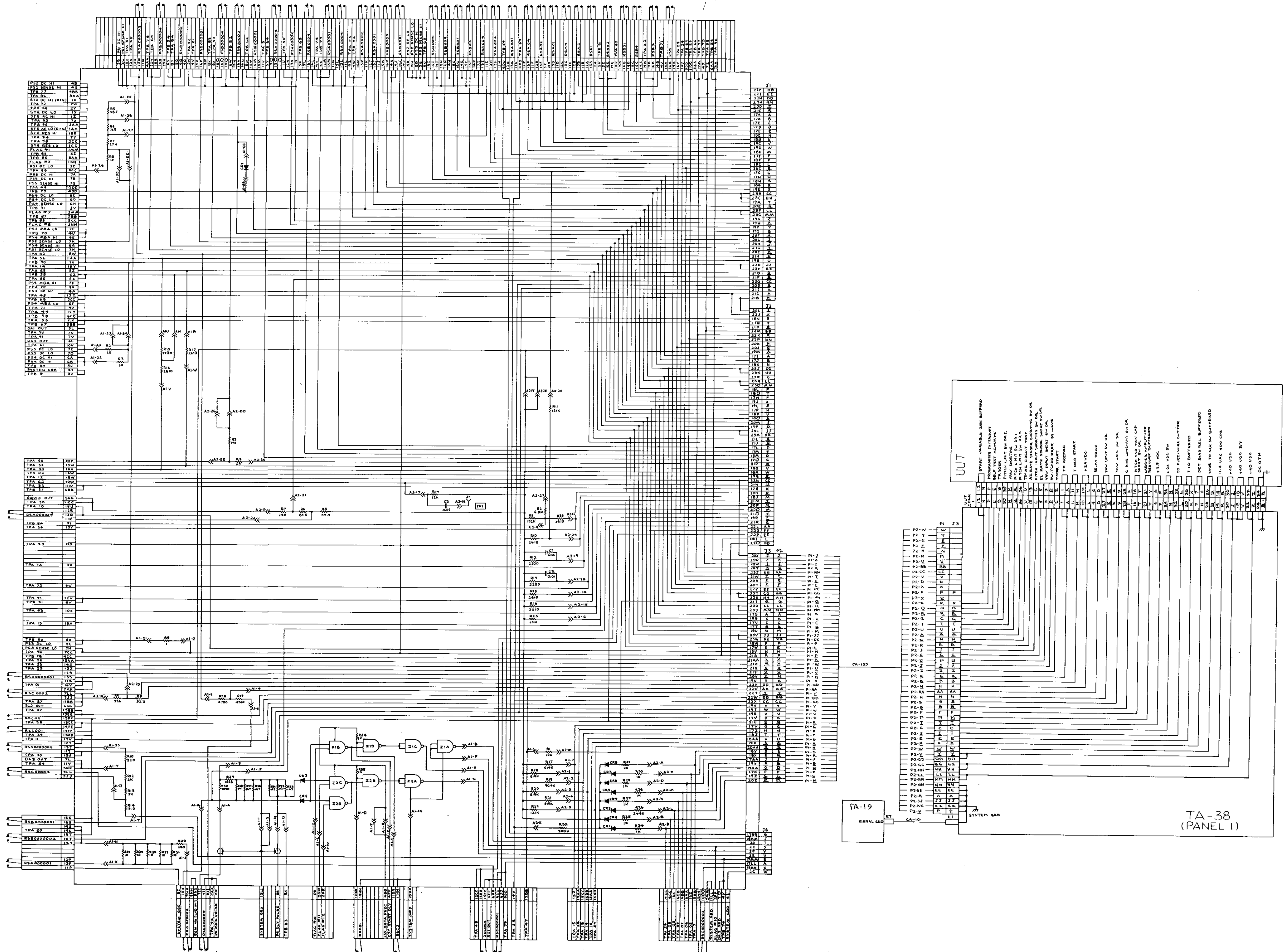

Figure 6-10. UUT 2240, Programmer Circuit Card Interconnection Diagram.

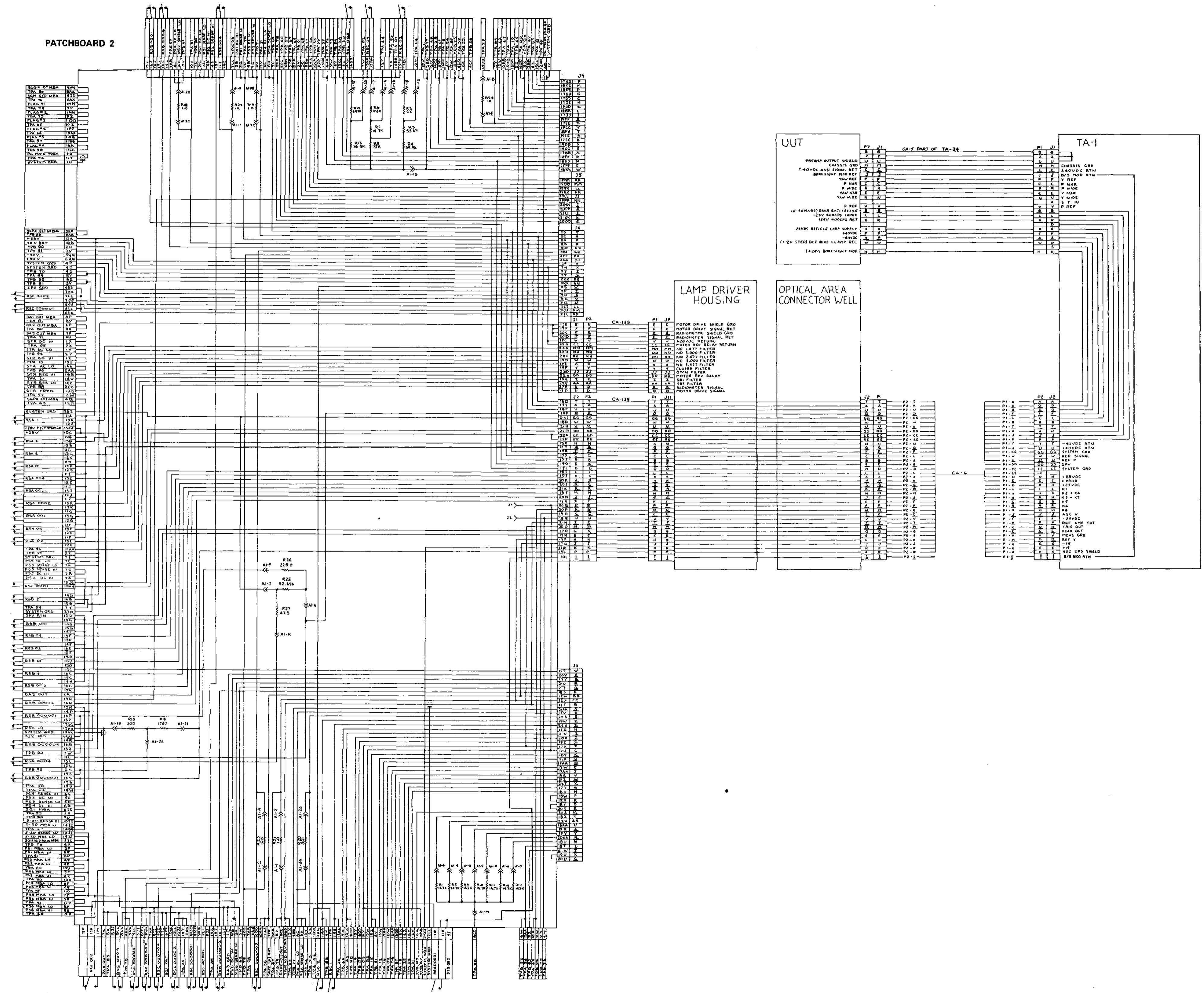

Figure 6-11. UUT 2300, optical sight interconnection diagram.

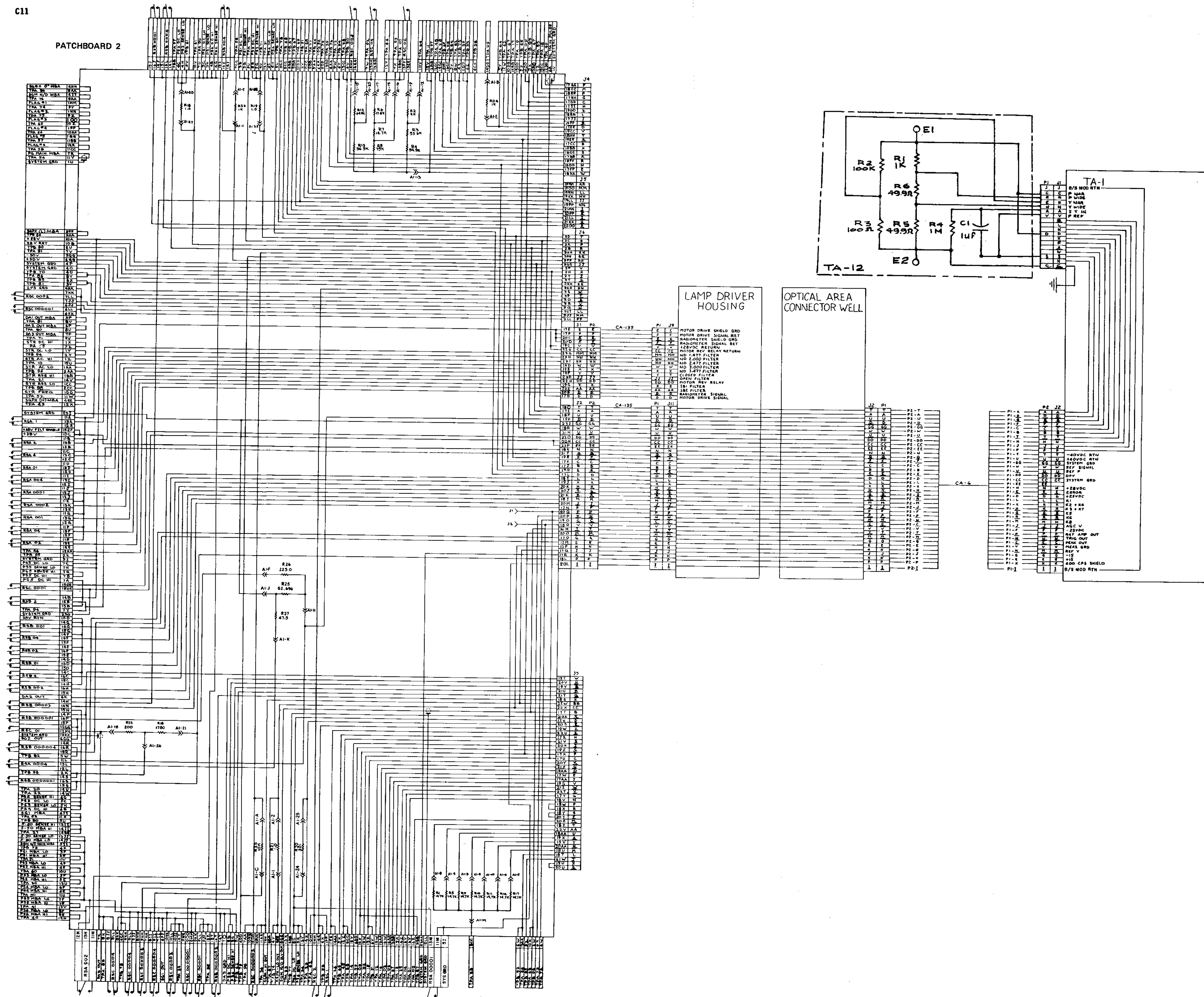

Figure 6-12. UUT 2300, optical sight (survey hook-up) interconnection diagram.

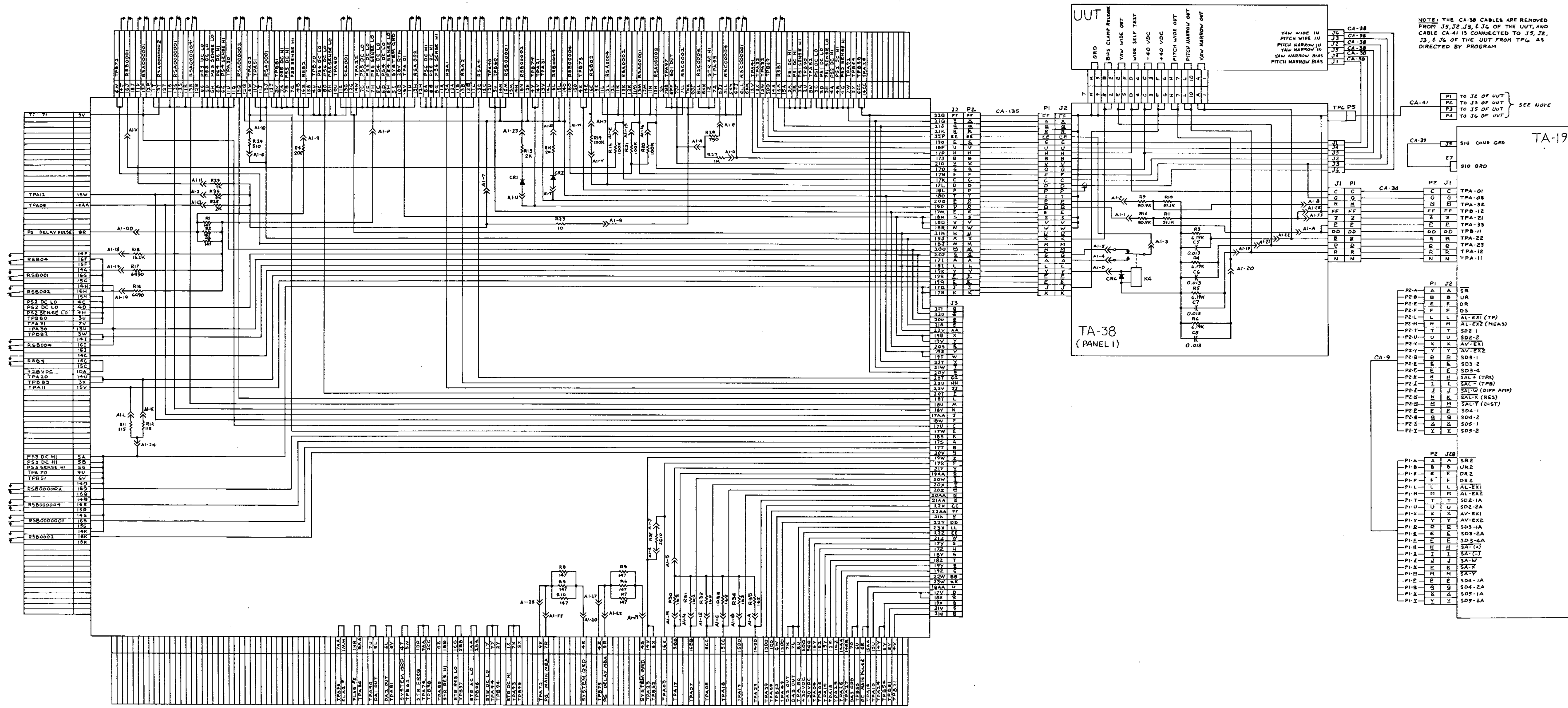

Figure 6-13. UUT 2380, Electronic Preamp Component Assembly Interconnection Diagram.



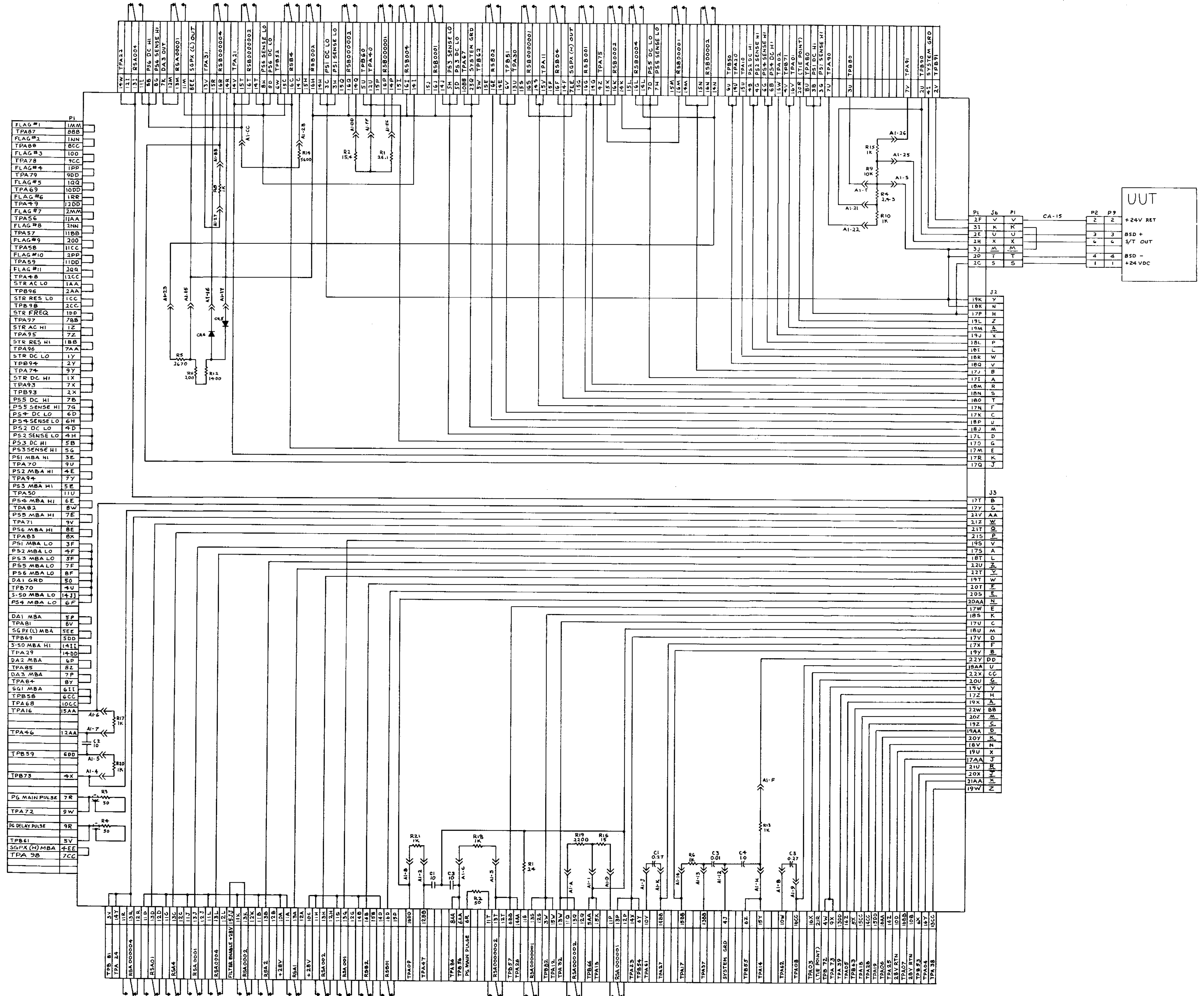

Figure 6-14. UUT 2440, Modulator, Electronic Component Subassembly Interconnection Diagram.

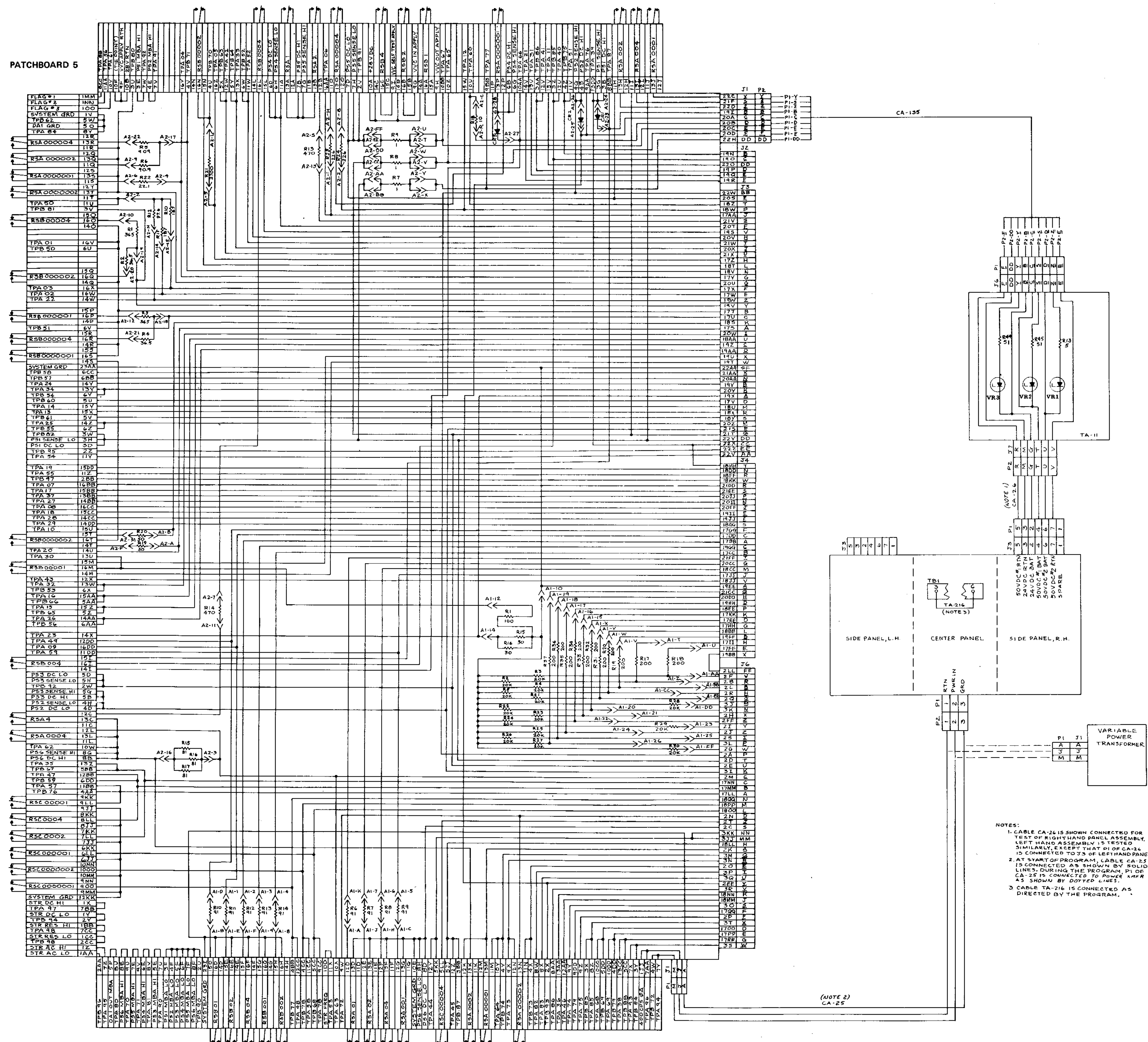

Figure 6-15. UUT 2600, battery charger interconnection diagram.

- NOTES:
1. CABLE CA-26 IS SHOWN CONNECTED FOR TEST OF RIGHT HAND PANEL ASSEMBLY. LEFT HAND ASSEMBLY IS TESTED SIMILARLY EXCEPT THAT P1 OF CA-26 IS CONNECTED TO J3 OF LEFTHAND PANEL.
  2. AT START OF PROGRAM, CABLE CA-23 IS CONNECTED AS SHOWN BY SOLID LINES. DURING THE PROGRAM, P1 OF CA-23 IS CONNECTED TO POWER AMPER AS SHOWN BY DOTTED LINES.
  3. CABLE TA-216 IS CONNECTED AS DIRECTED BY THE PROGRAM.

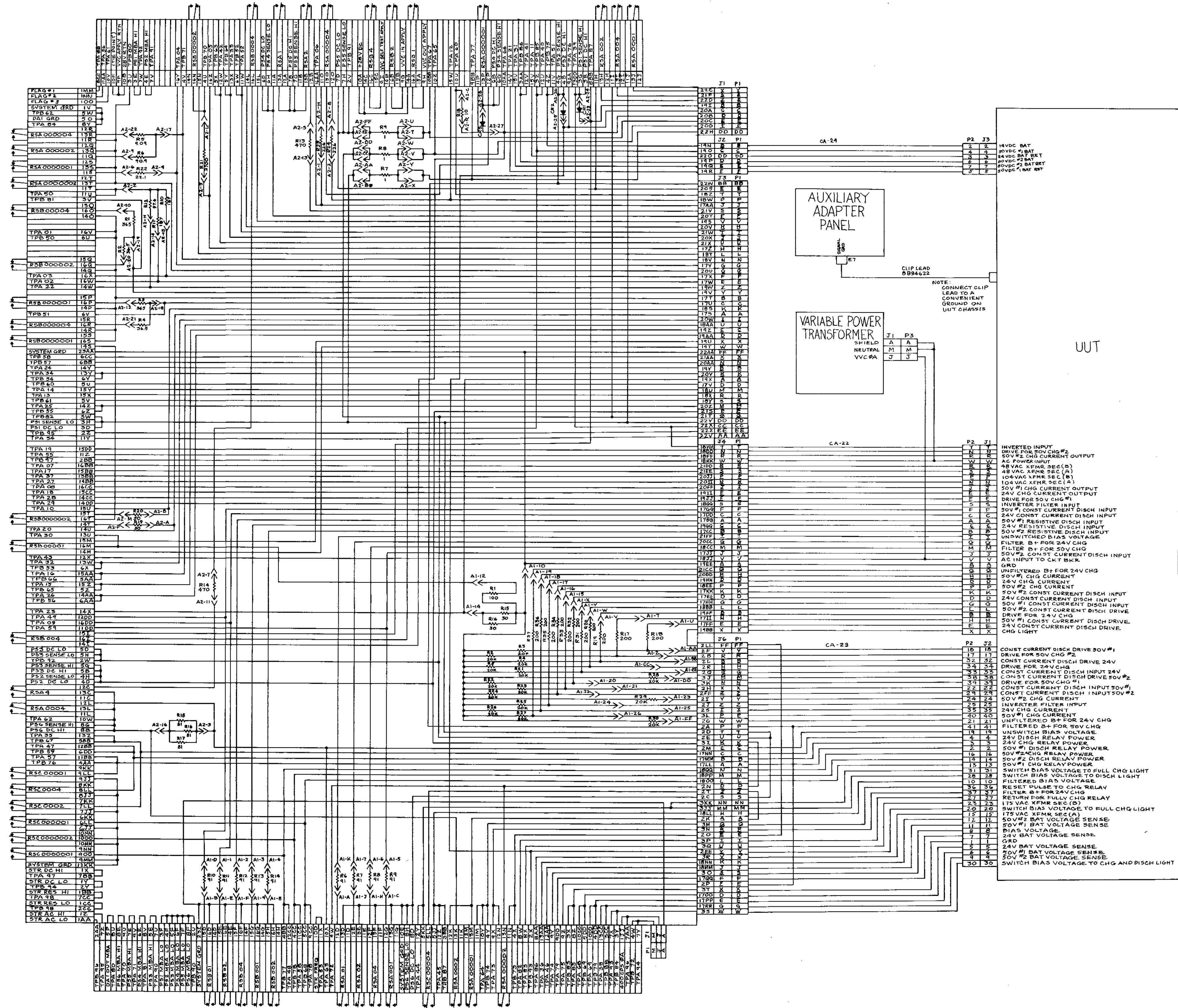

Figure 6-16. UUT 2610, Battery Charger Panel Assembly (Left or Right) Interconnection diagram.

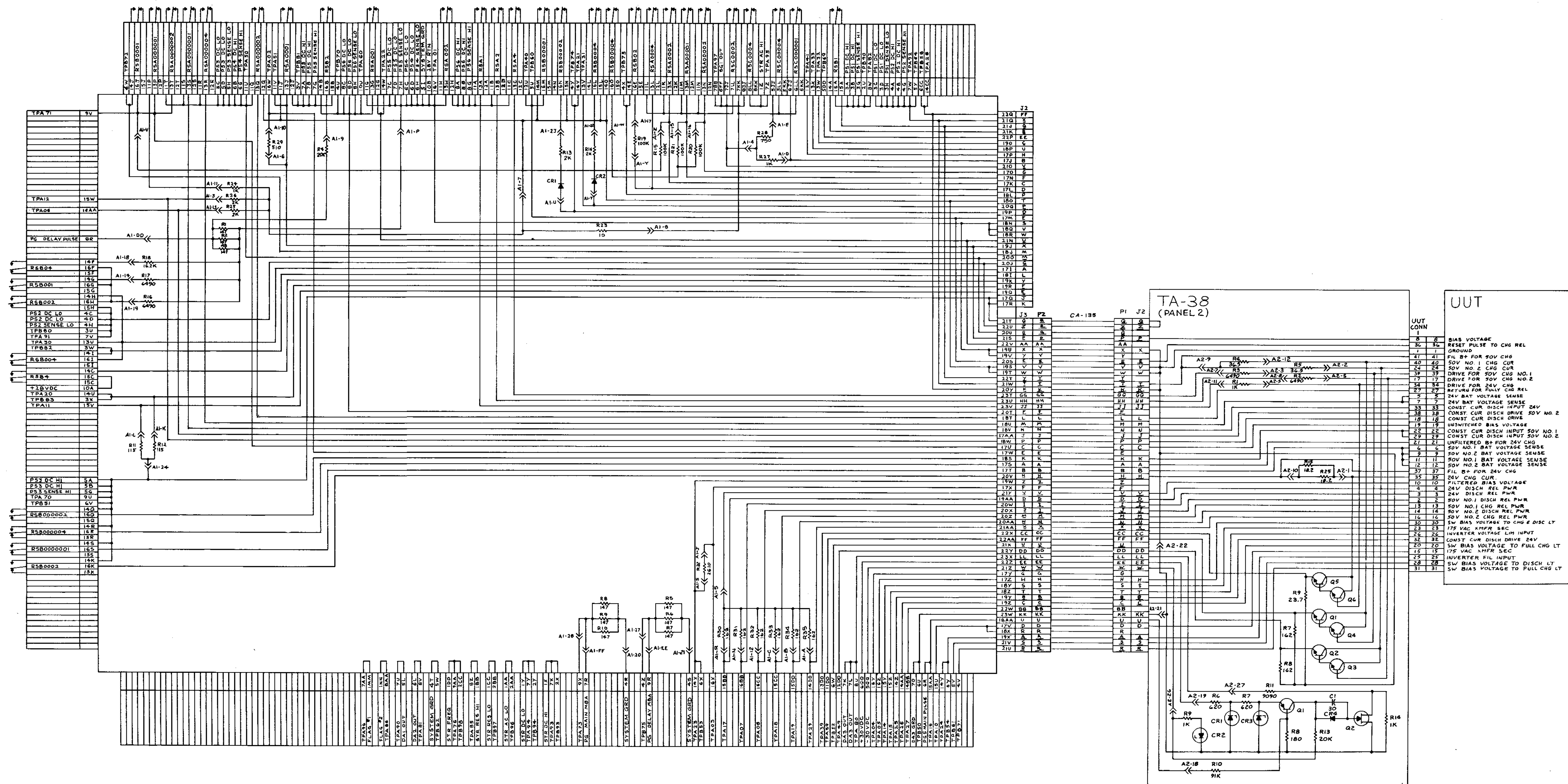

Figure 6-17. UUT 2612, Circuit Card Assembly Interconnection Diagram.

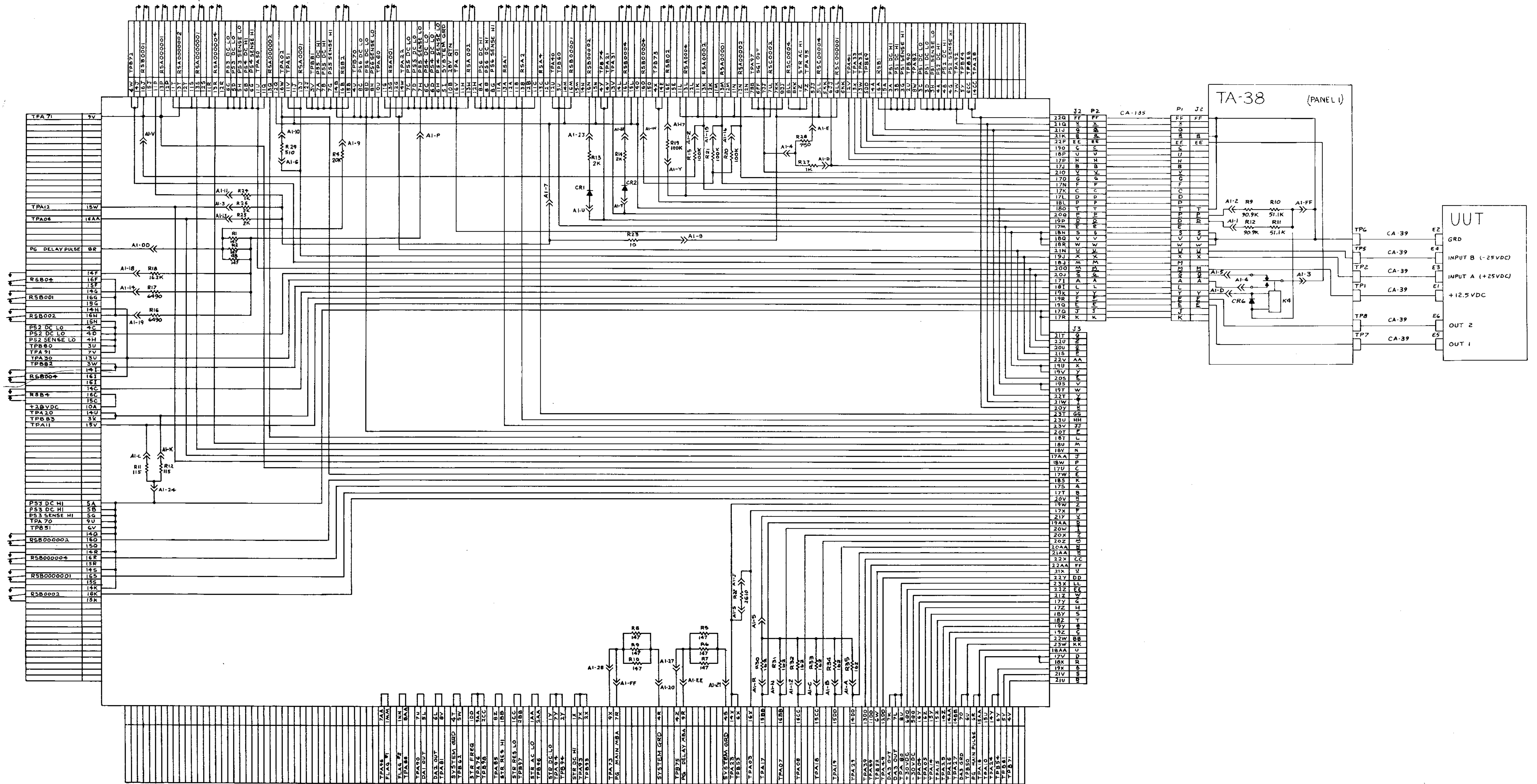

Figure 6-18. UUT 2613, Inverter Circuit Card Interconnection Diagram.

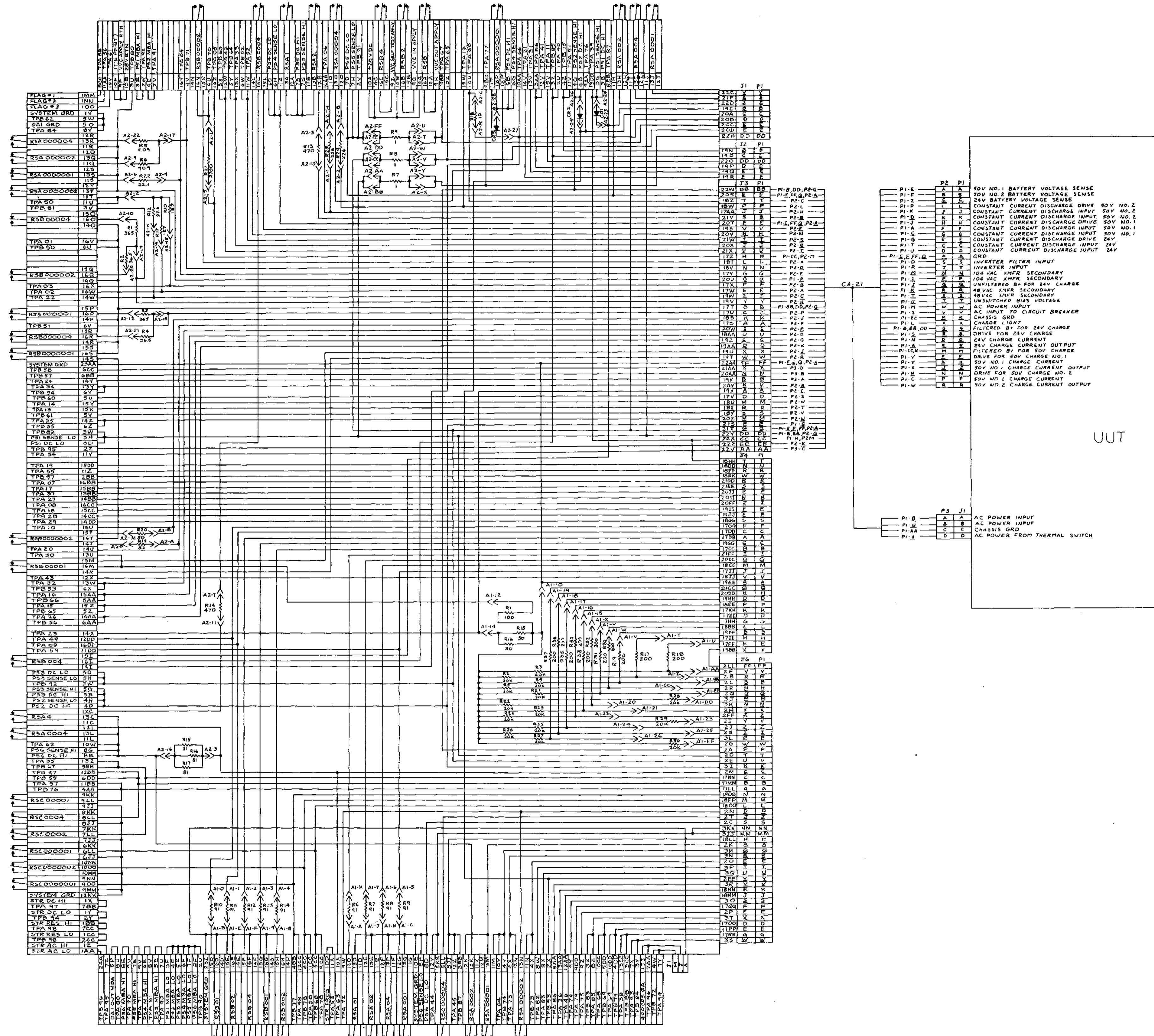

Figure 6-19. UUT 2614, Battery Charger Heat Sink Assembly Interconnection Diagram.

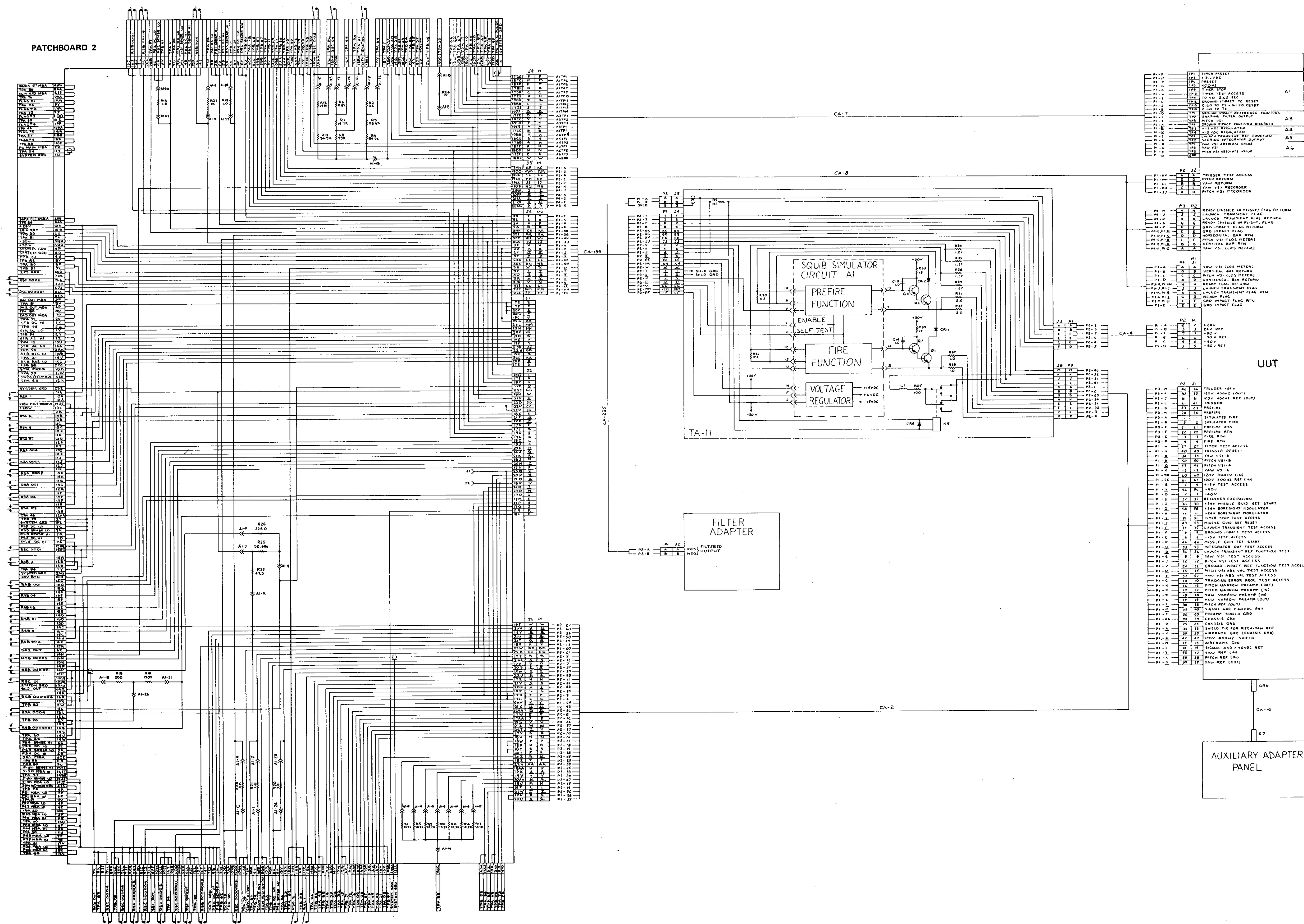

Figure 6-20. UUT 3110, instructor console interconnection diagram.

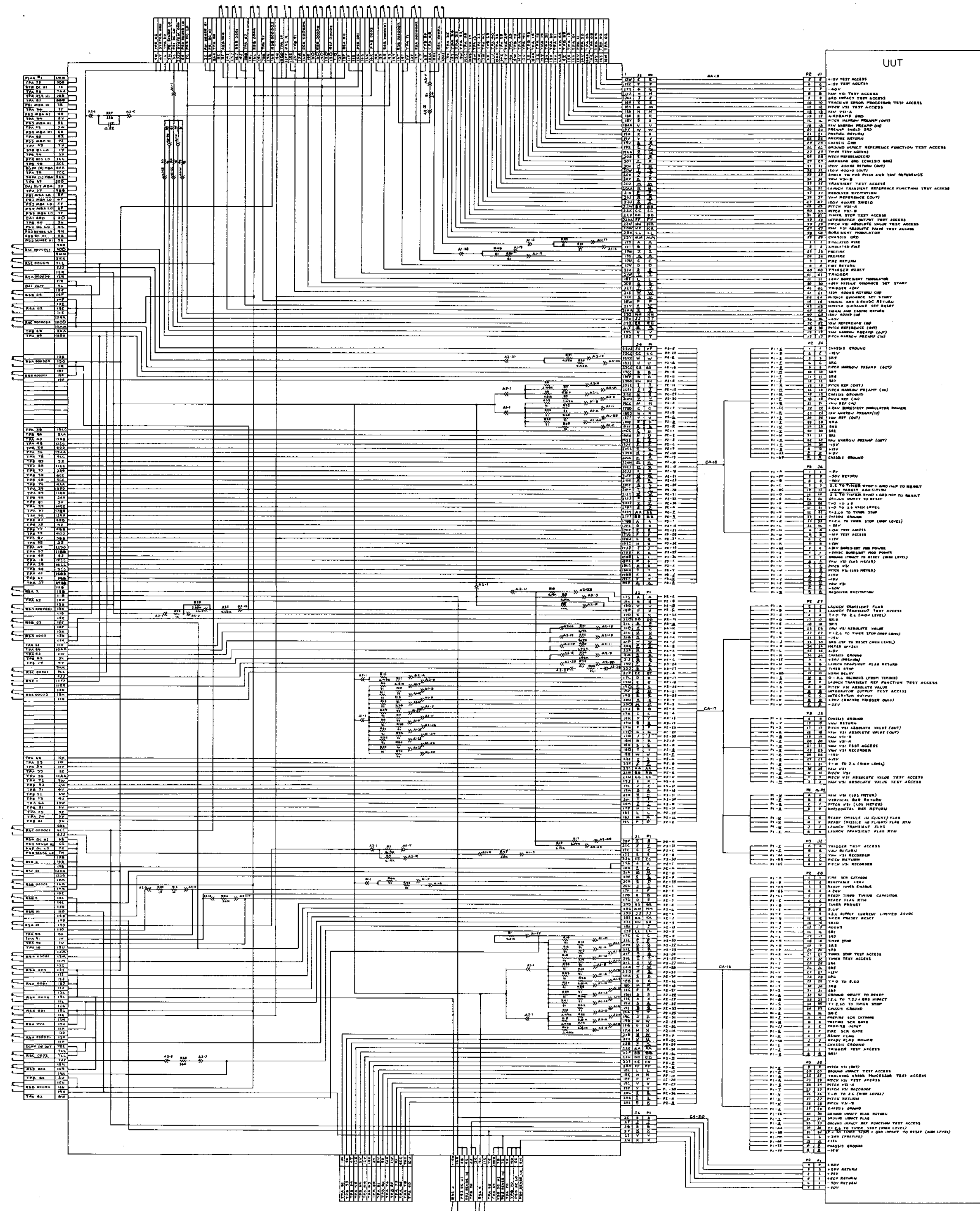

Figure 6-21. UUT 3120, Instructor Console Electronic Assembly Interconnection Diagram.



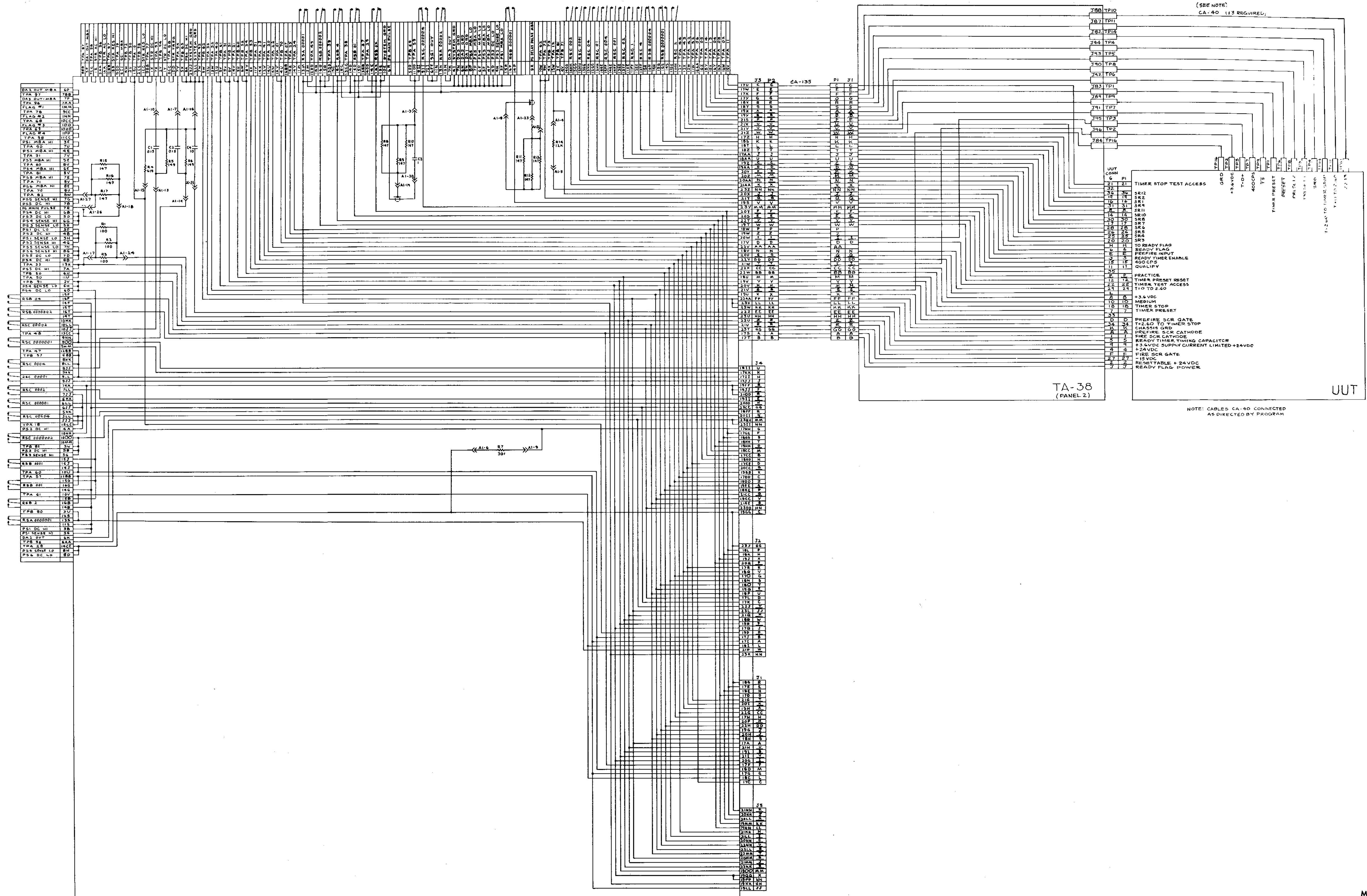

Figure 6-22. UUT 8121. Digital Timing Circuit Card Interconnection Diagram.

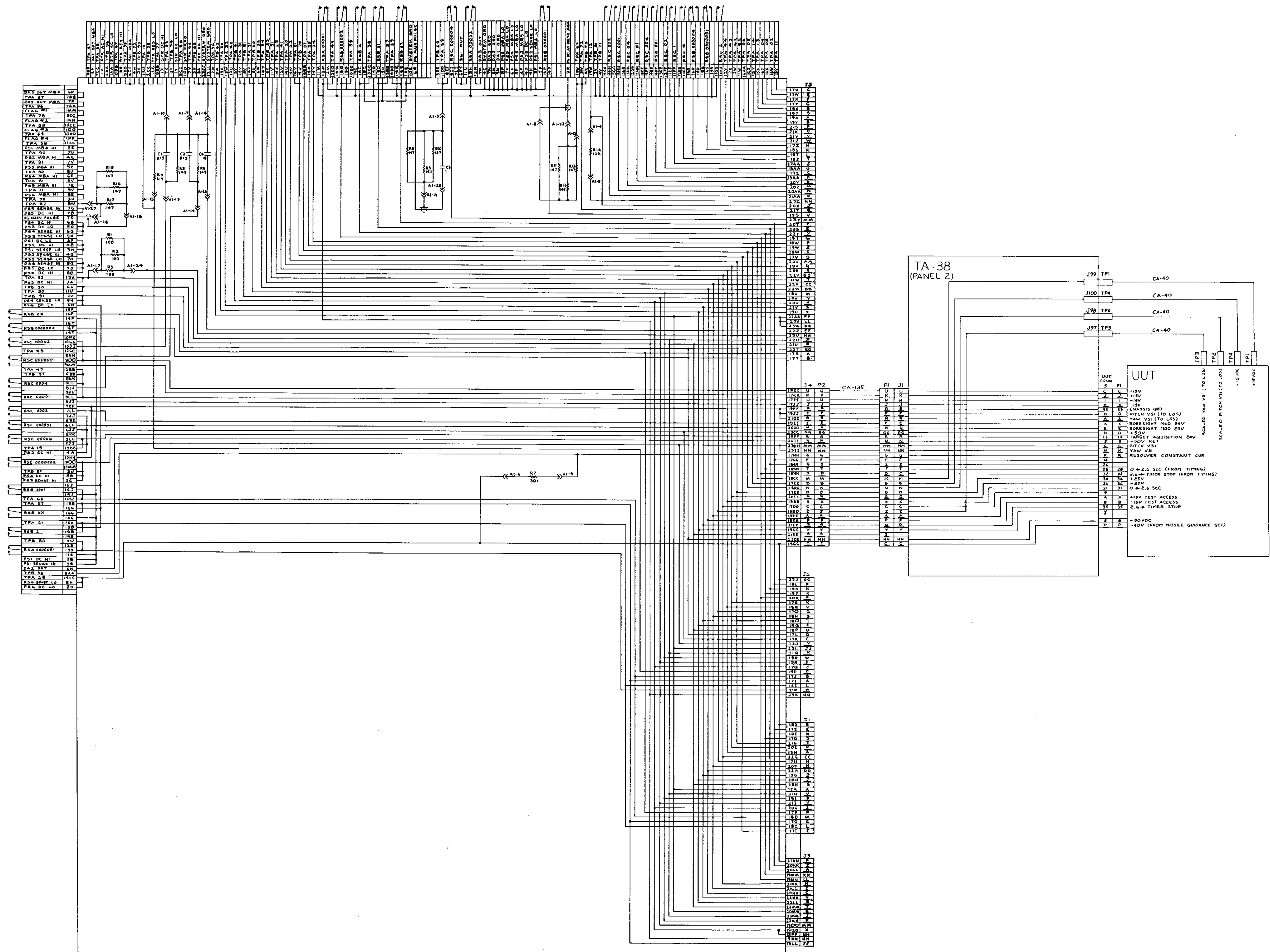

Figure 6-23. UUT 3123, Power Supply Circuit Card Interconnection Diagram.

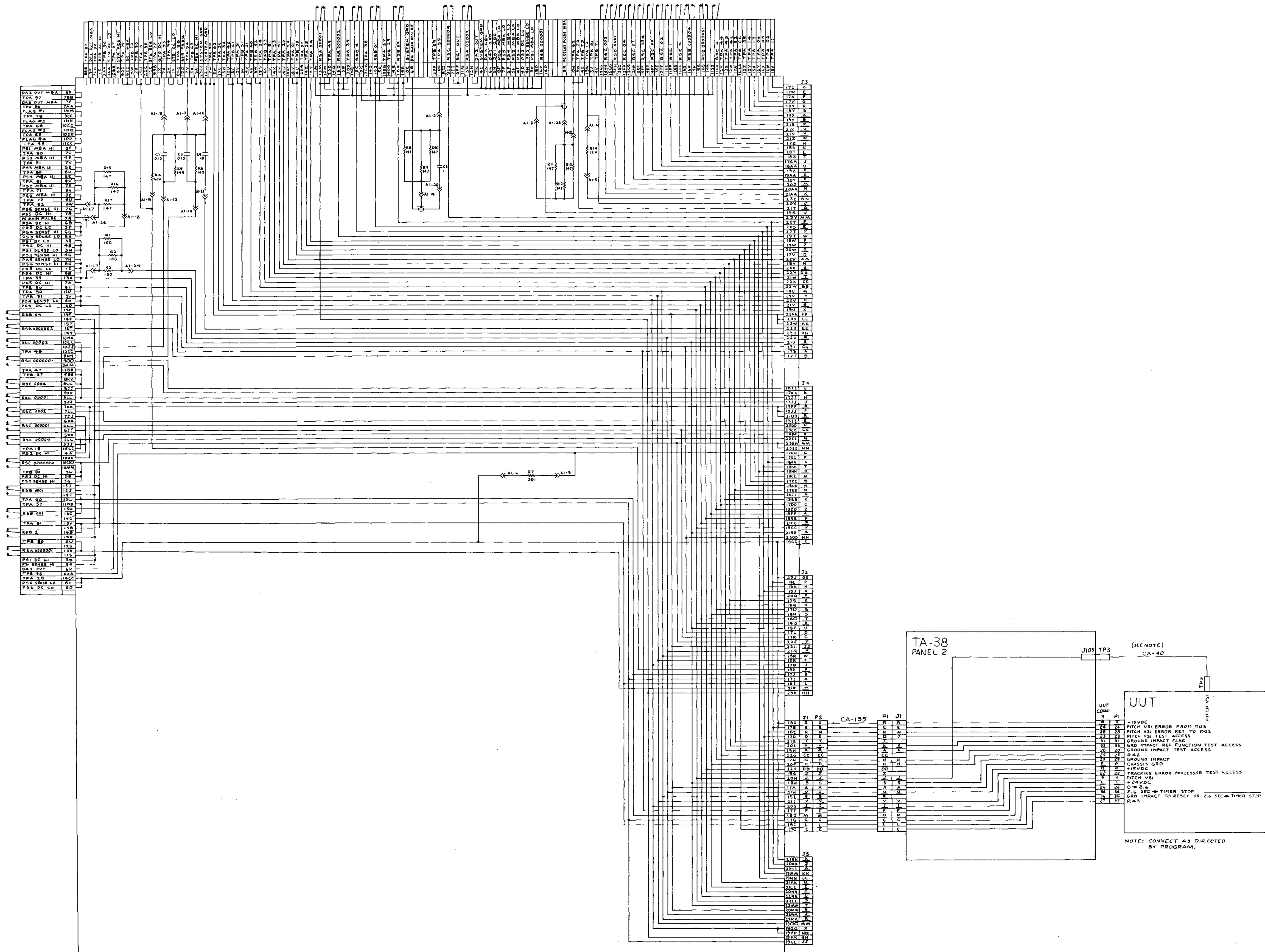

Figure 6-24. UUT 3124, Scoring Circuit No. 1 Circuit Card Interconnection Diagram.

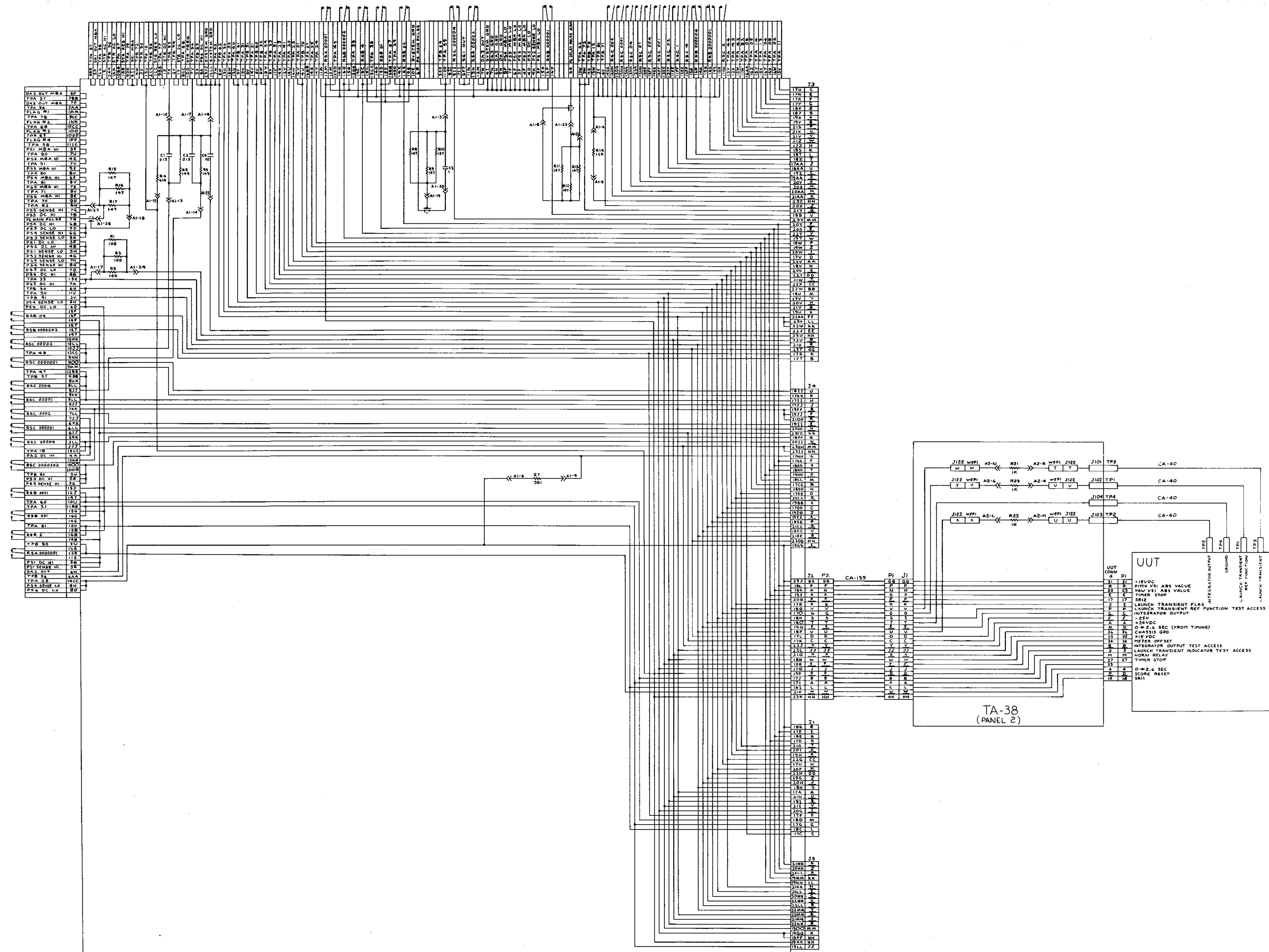

Figure 6-25. UUT 3125, Scoring Circuit No. 2 Circuit Card Interconnection Diagram.

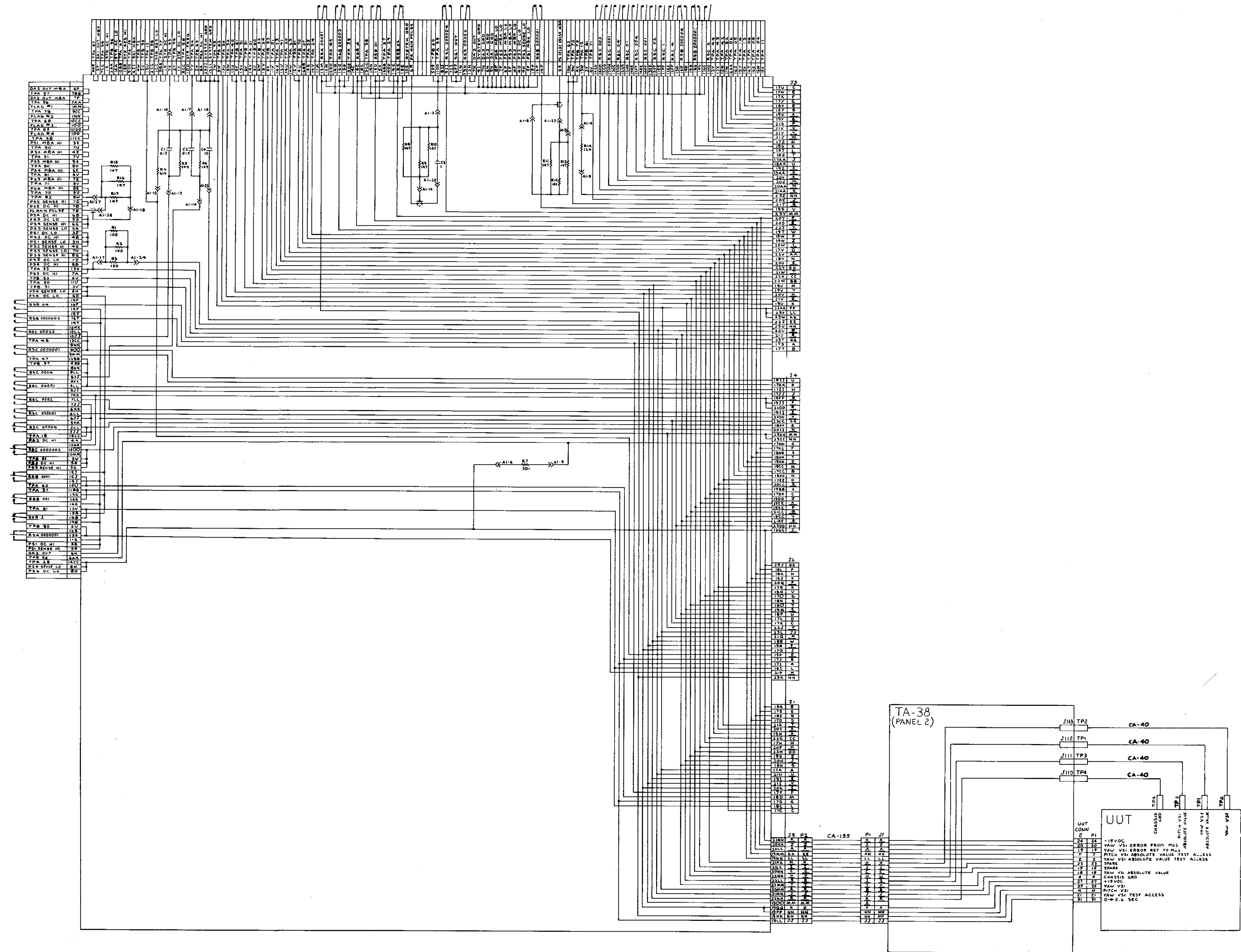

Figure 6-26. UUT 3126, Scoring Circuit No. 3 Circuit Card Interconnection Diagram.

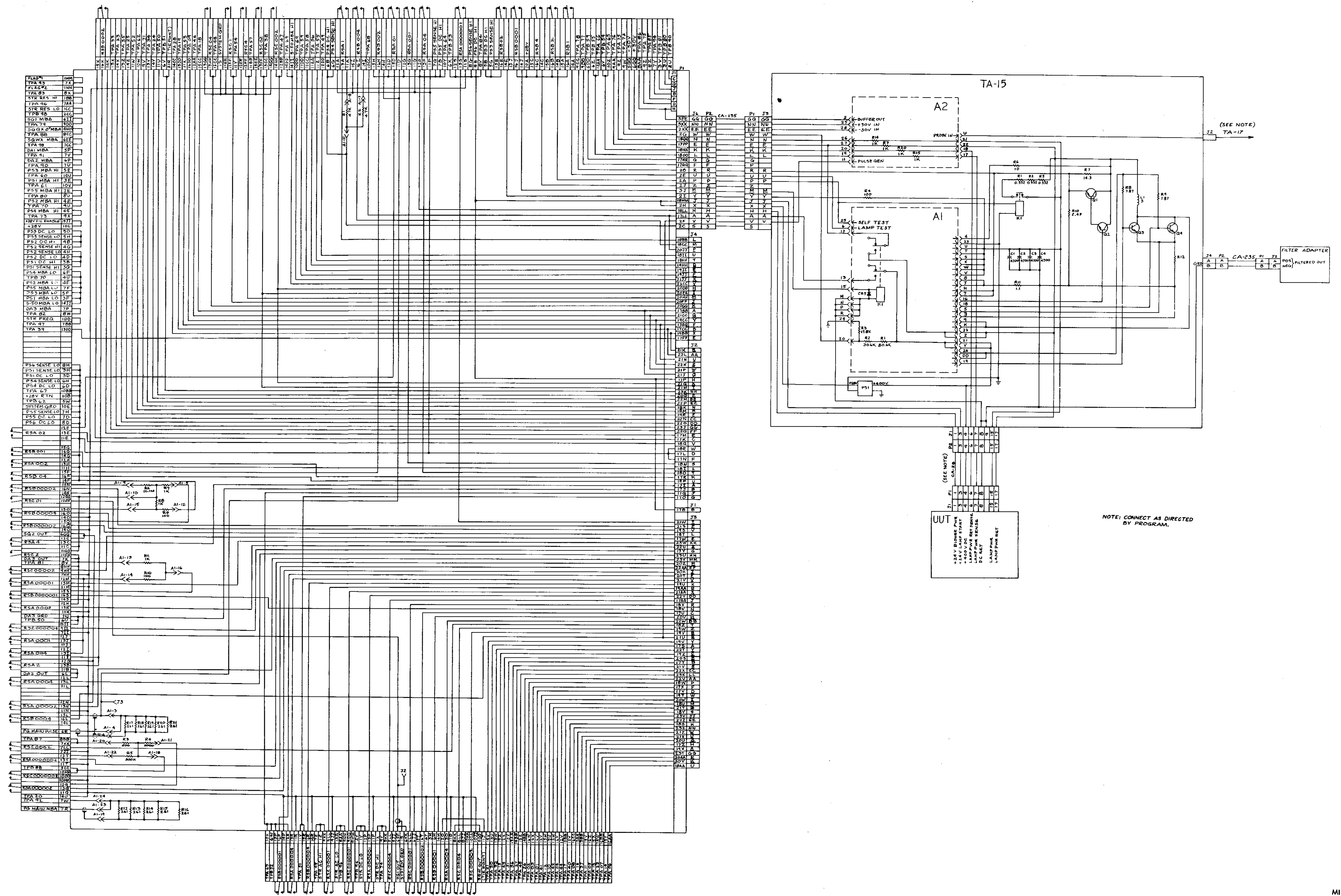
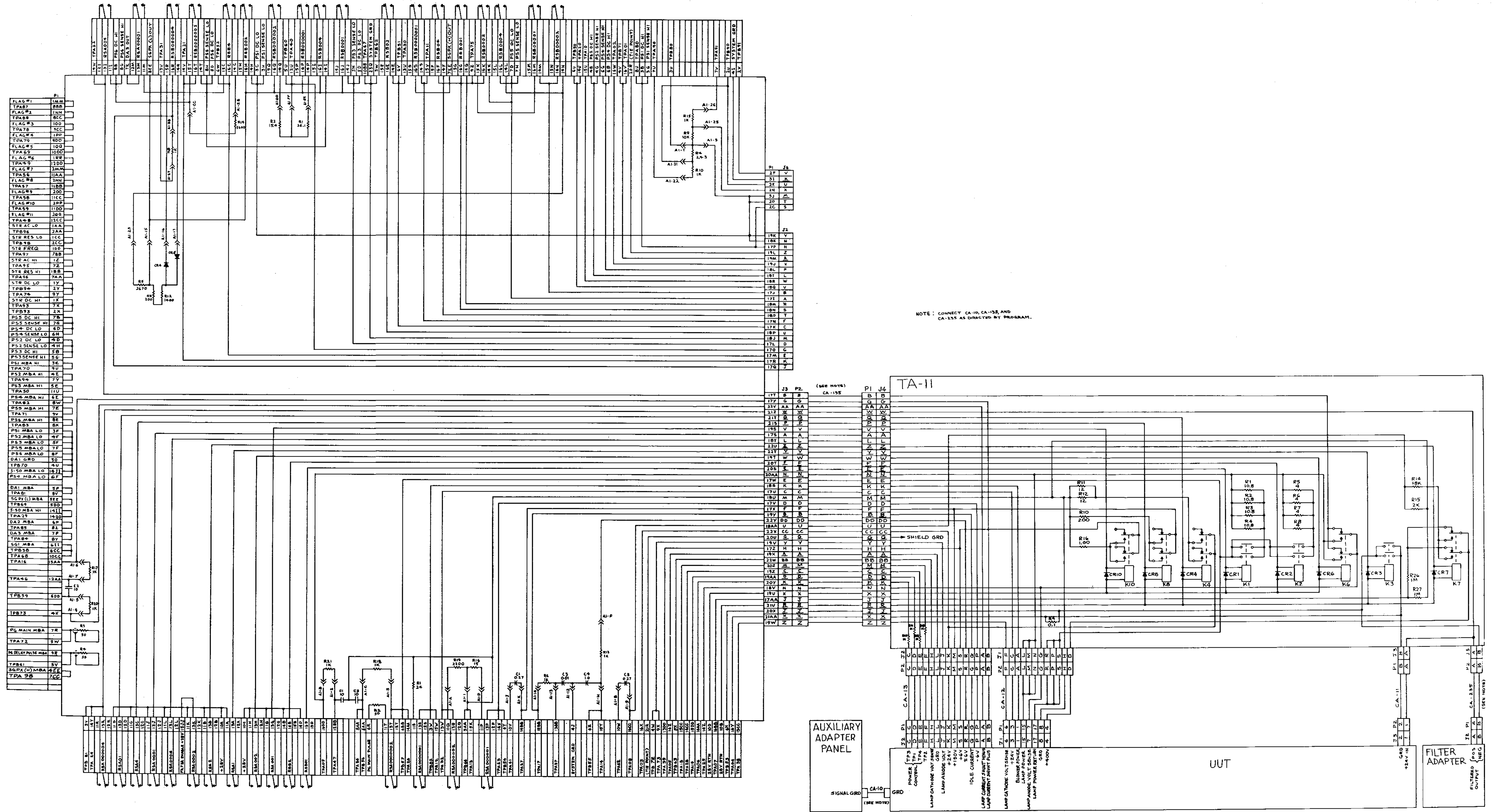

Figure 6-27. UUT 3140, Target Source Assembly Interconnection Diagram.



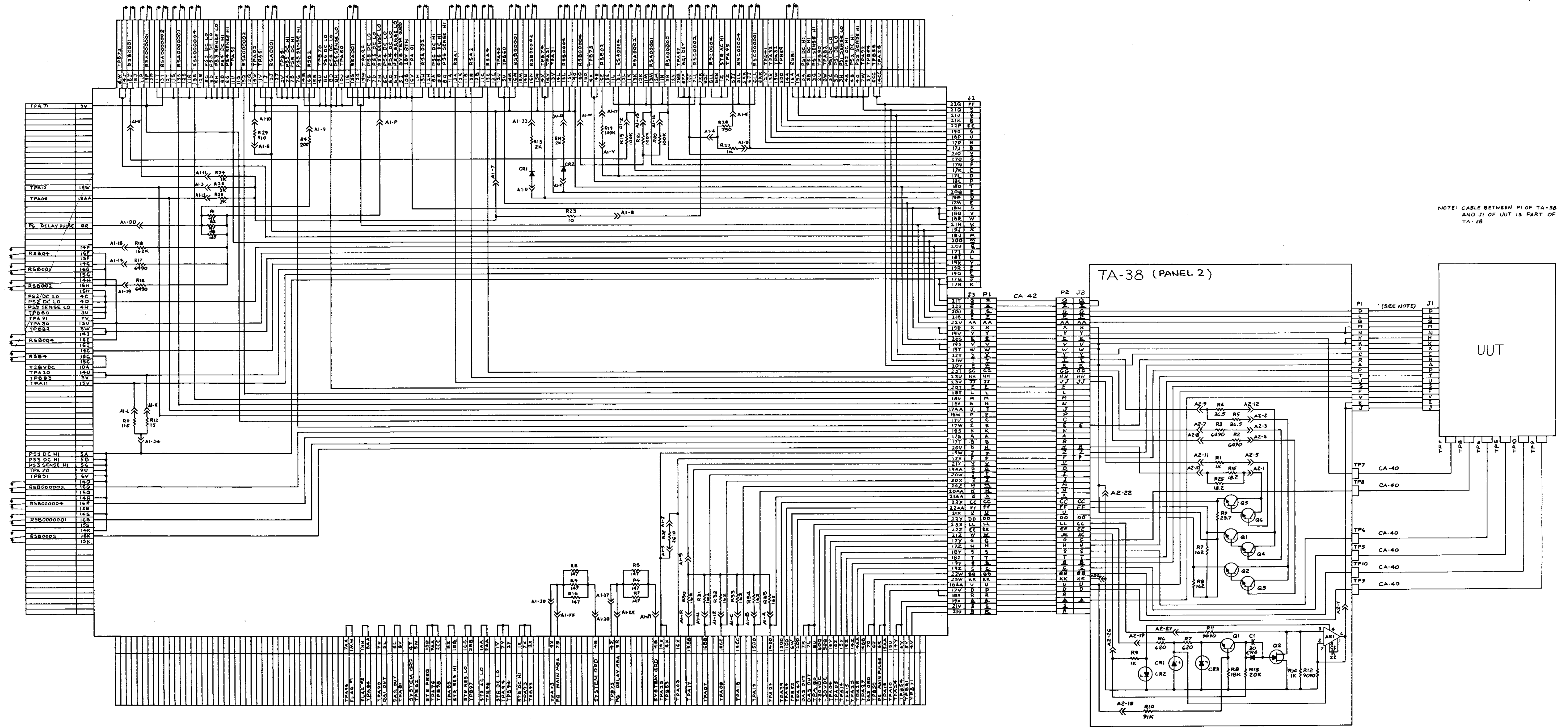

Figure 6-29. UUT 3151, Power Control Circuit Card Interconnection Diagram.



CHAPTER 8  
LANCE INTERCONNECTION DIAGRAMS

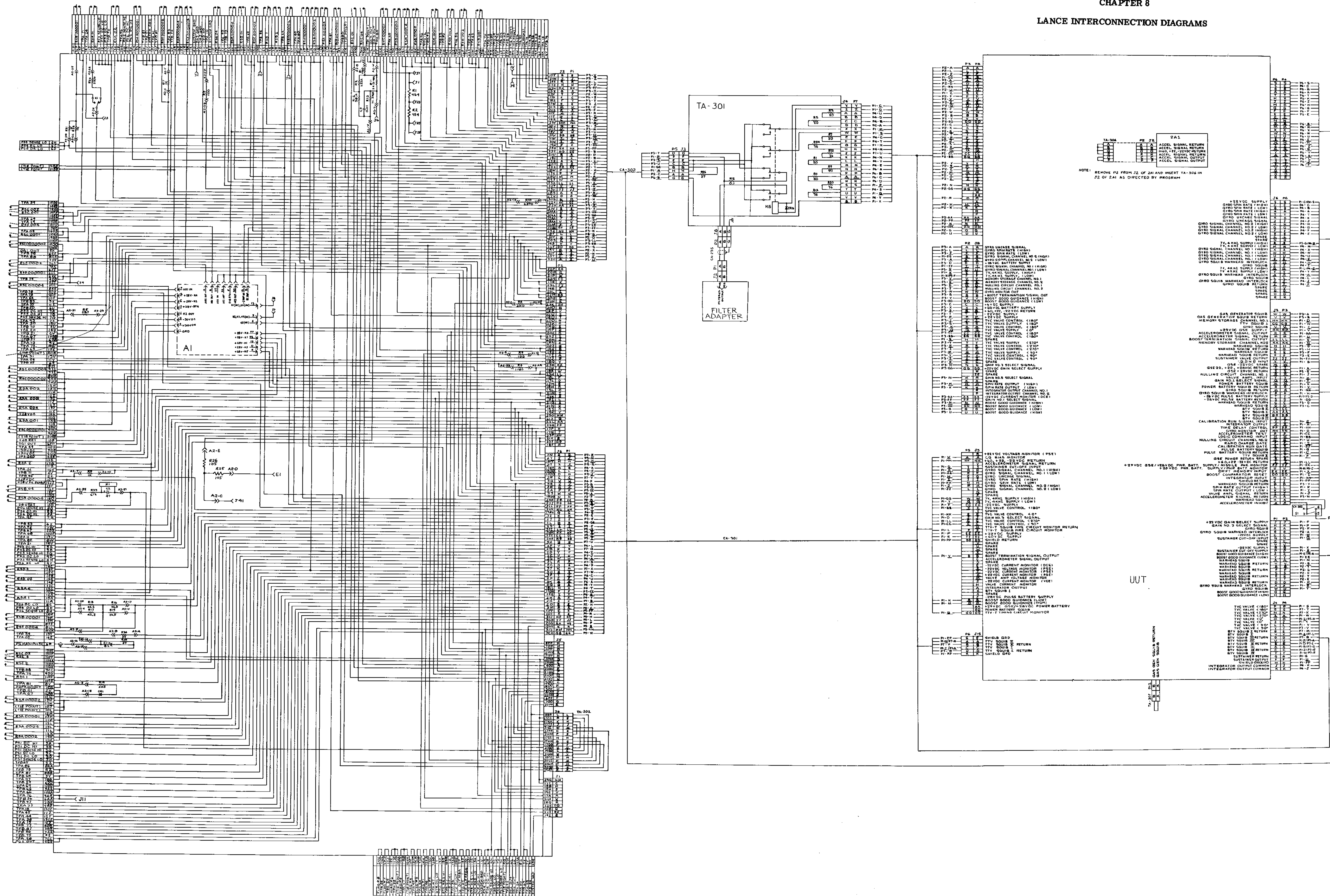
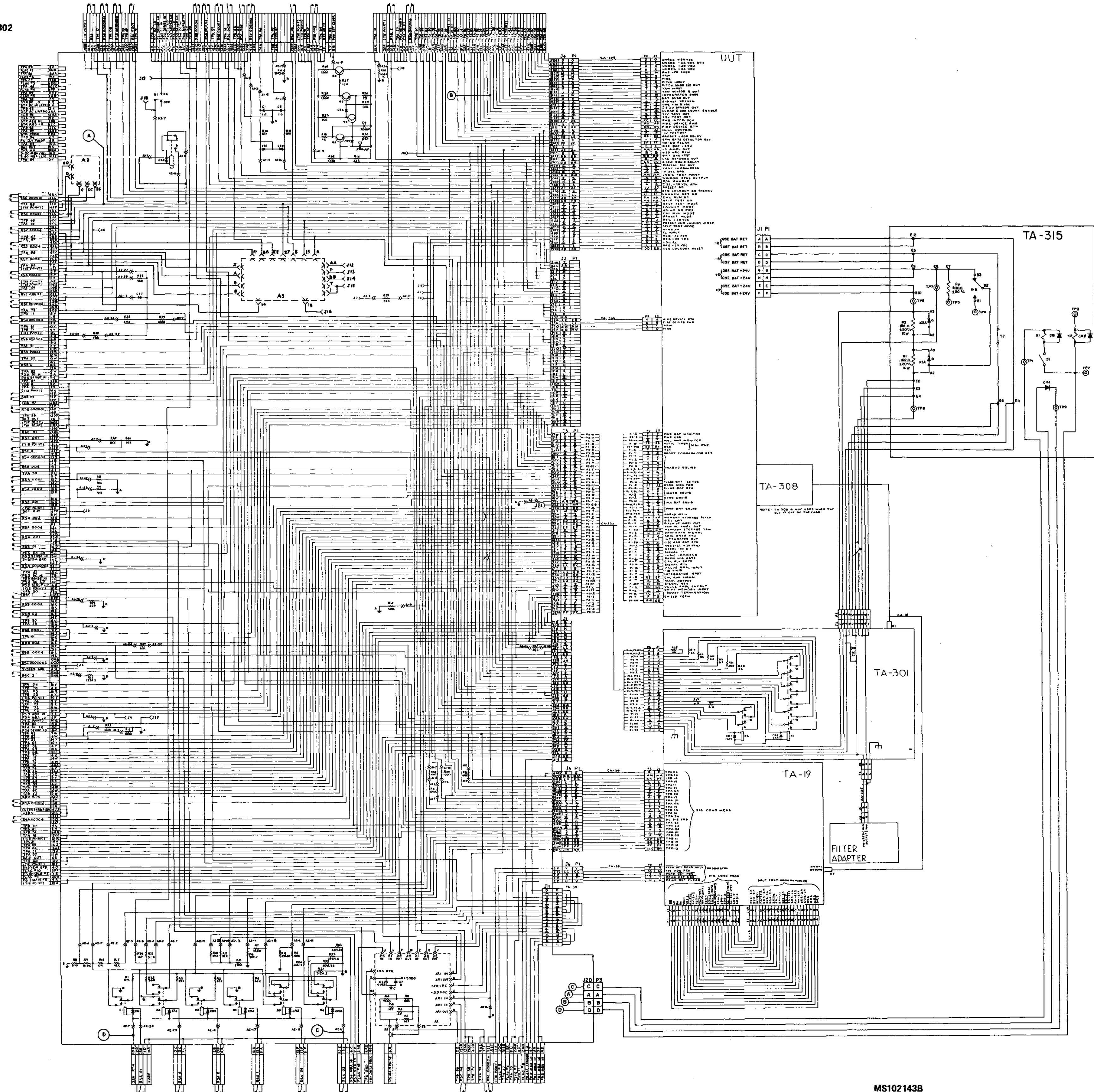

Figure 8-1. UUT 1300, Missile Guidance Set Interconnection Diagram.

PATCHBOARD 302



MS102143B

Figure 8-2. UUT 4500, Missile Guidance Set Monitor Programmer Interconnection Diagram.

PATCHBOARD 302

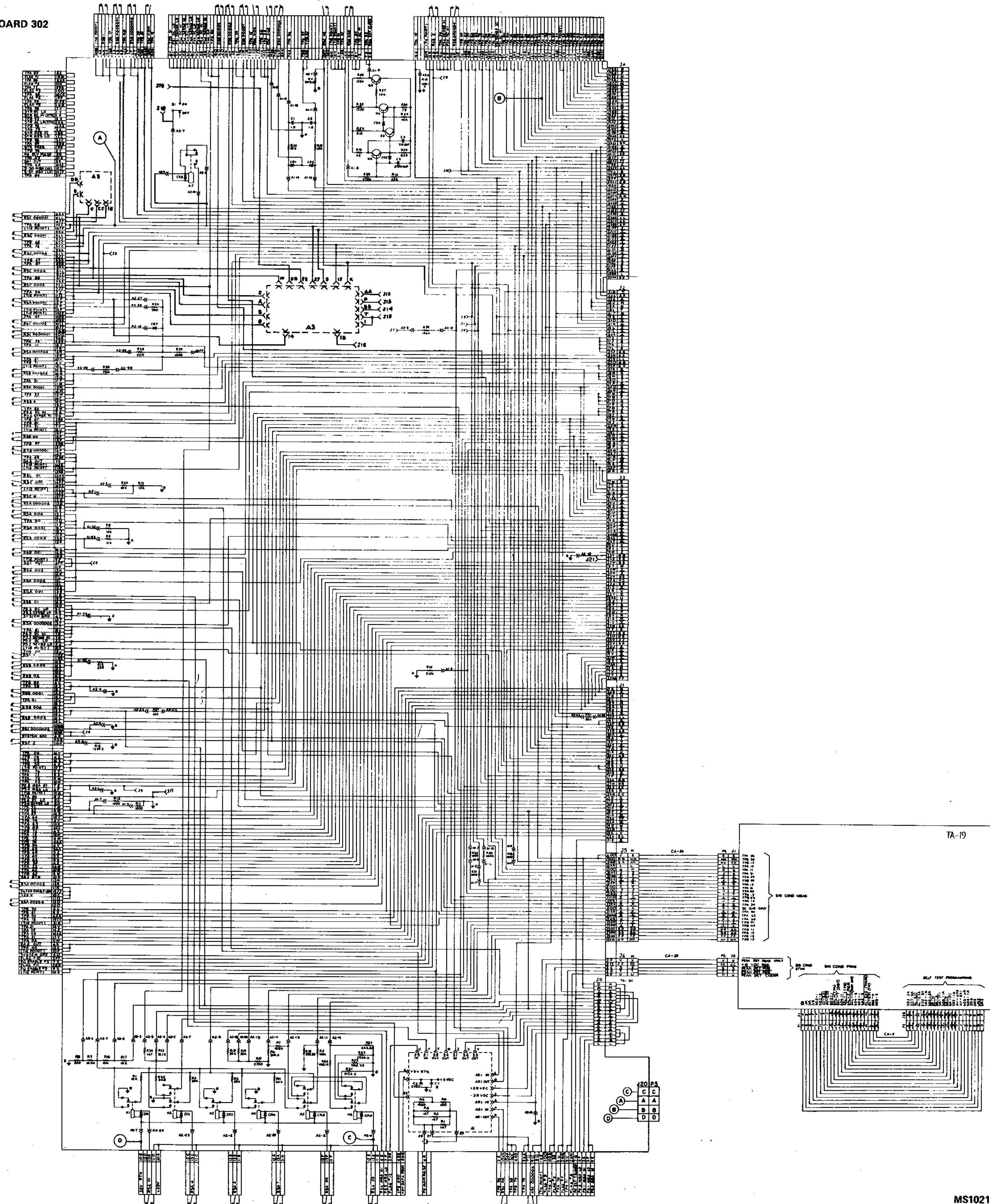

Figure 8-3. UUT 4500, Missile Guidance Set Monitor Programmer (Survey Hook-Up) Interconnection Diagram.

MS102144B

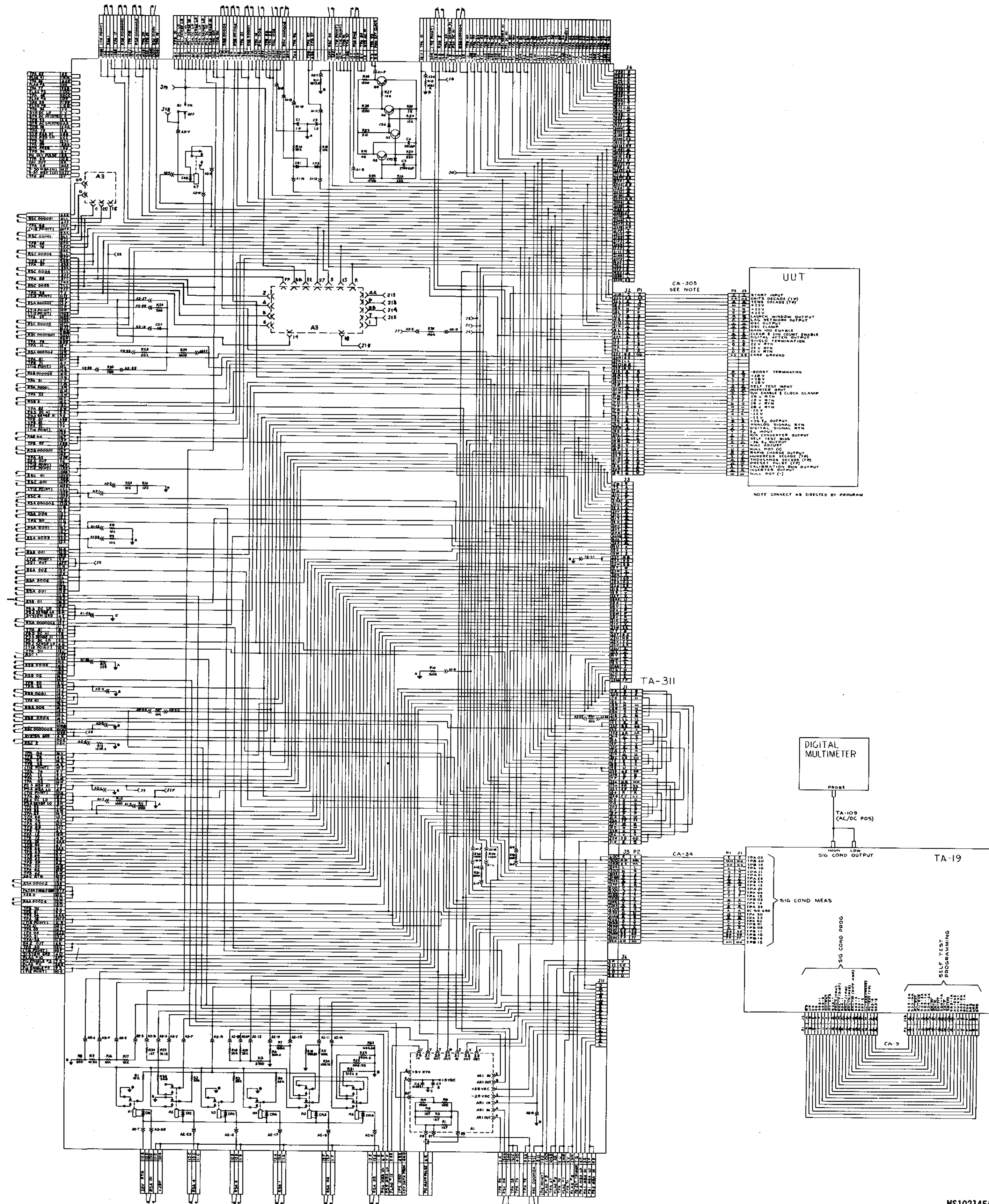

Figure 8-4. UUT 4530, Velocity Preset Assembly Interconnection Diagram.

MS102145A

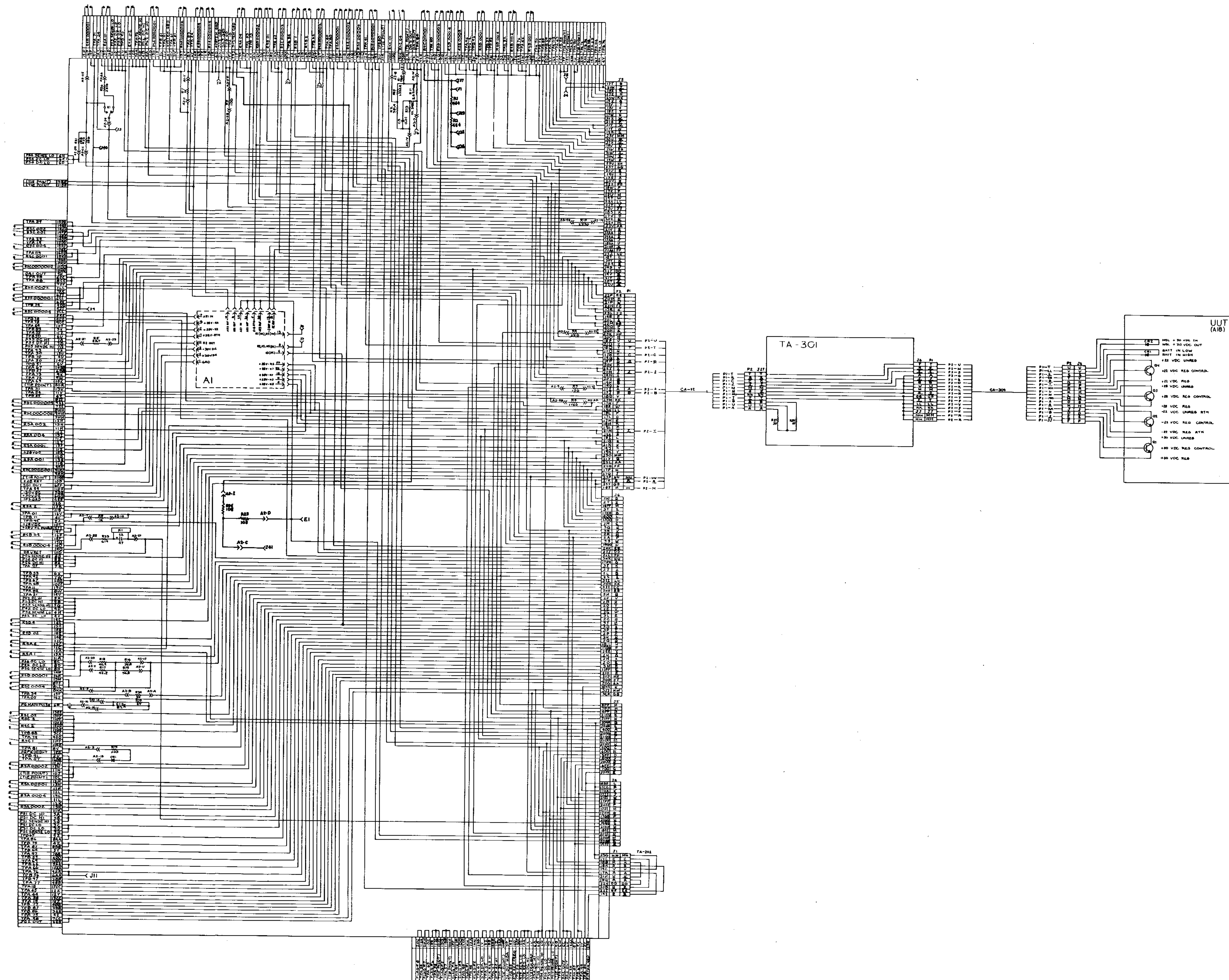

Figure 8-5. UUT 4550, Power Module Assembly (A18) Interconnection Diagram.

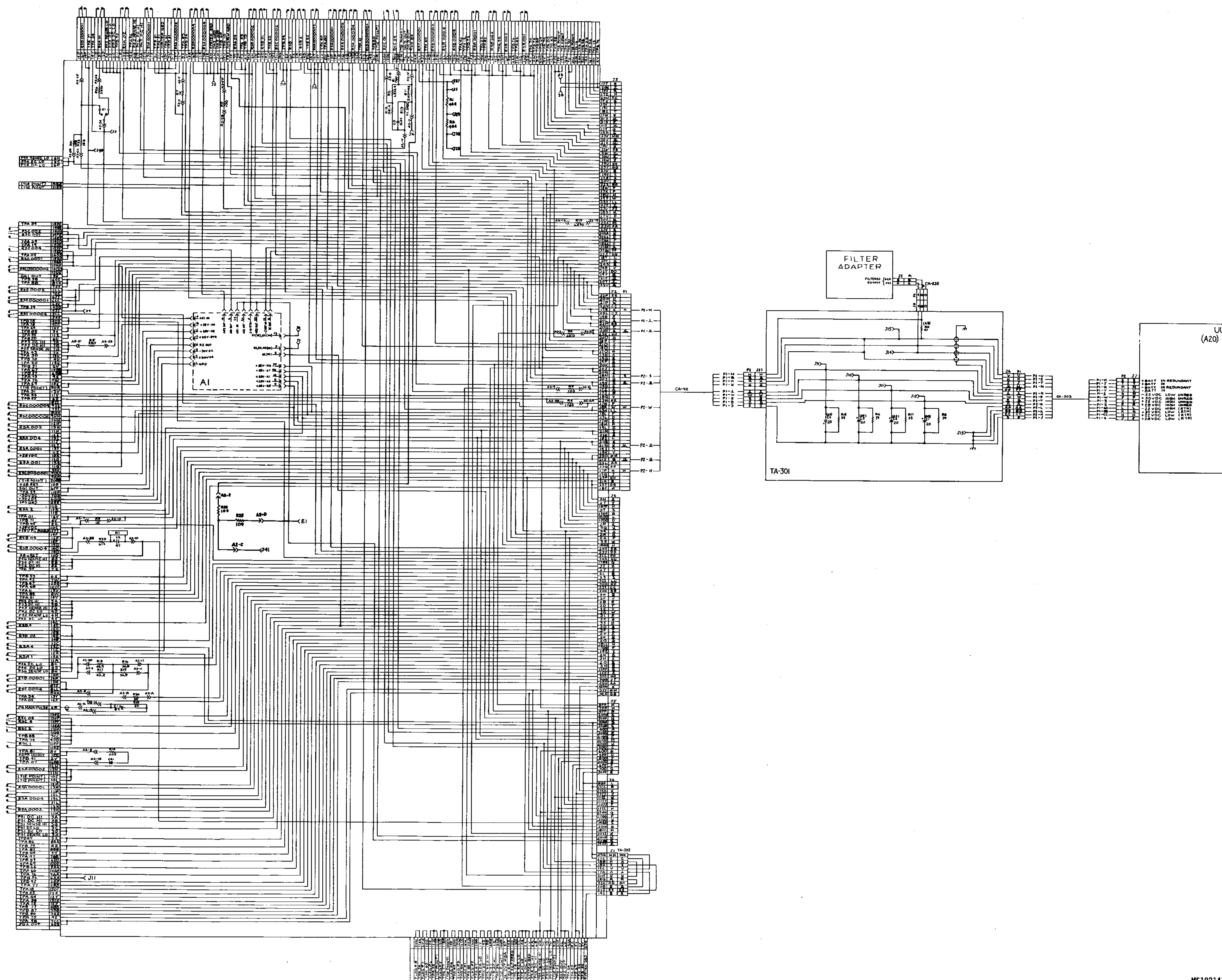

Figure 8-6. UUT 4550, Power Supply Assembly (A20) Interconnection Diagram.

MS102147A

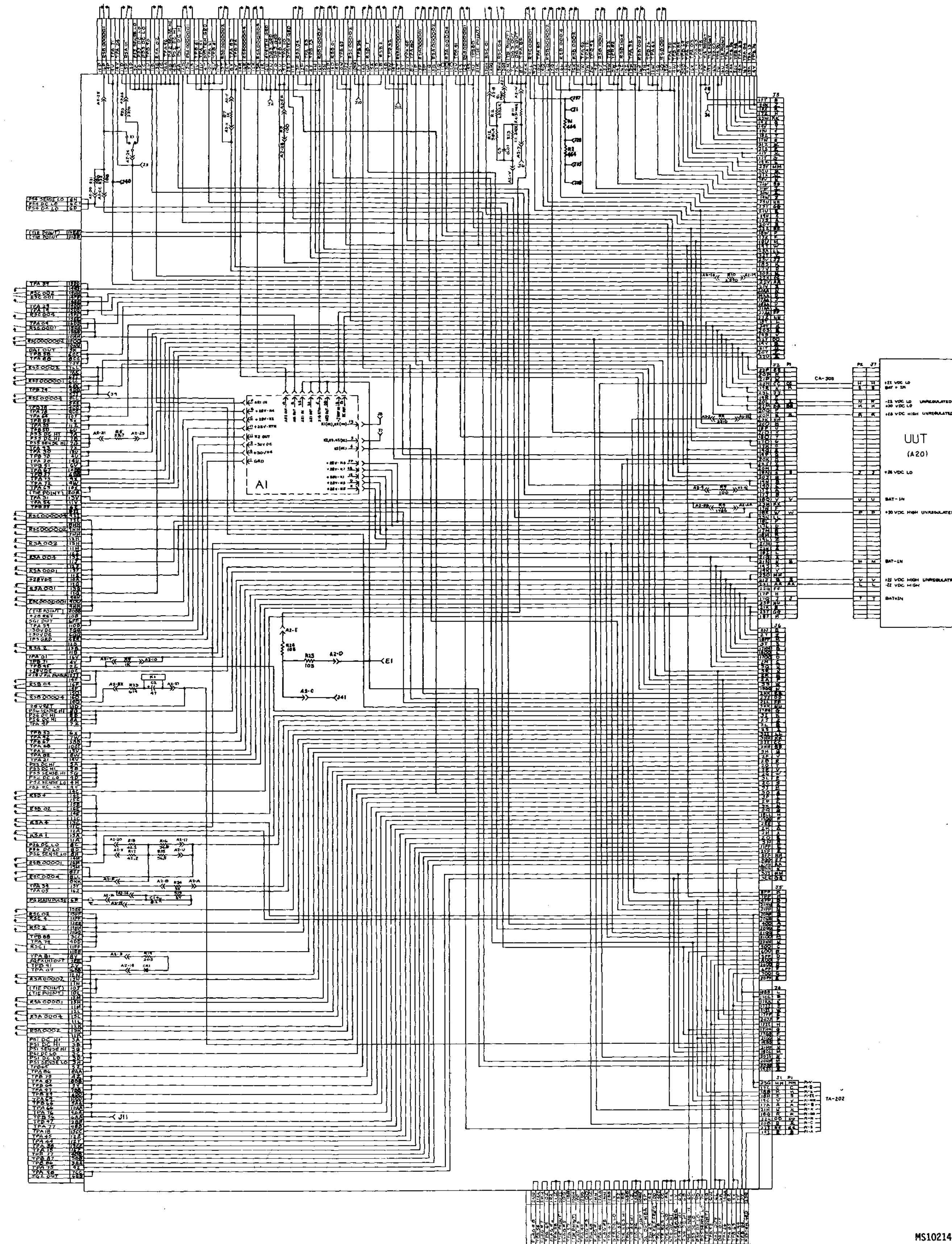

Figure 8-7. UUT 4550, Power Module Assembly (Go-Chain Change 1) Interconnection Diagram.

MS102148A

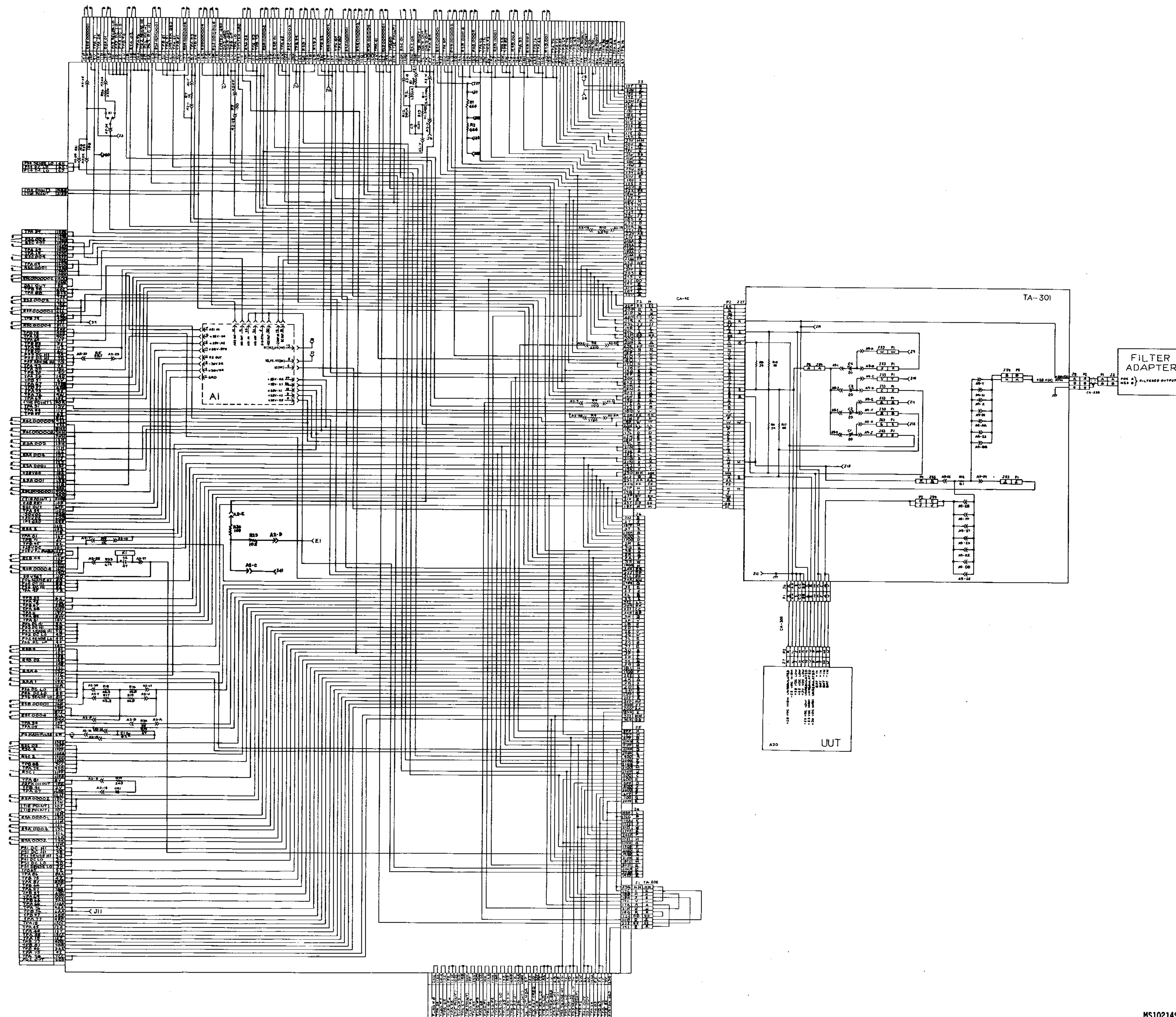

Figure 8-8. UUT 4550, Power Module Assembly (Go-Chain Change 2) Interconnection Diagram.

MS102149A



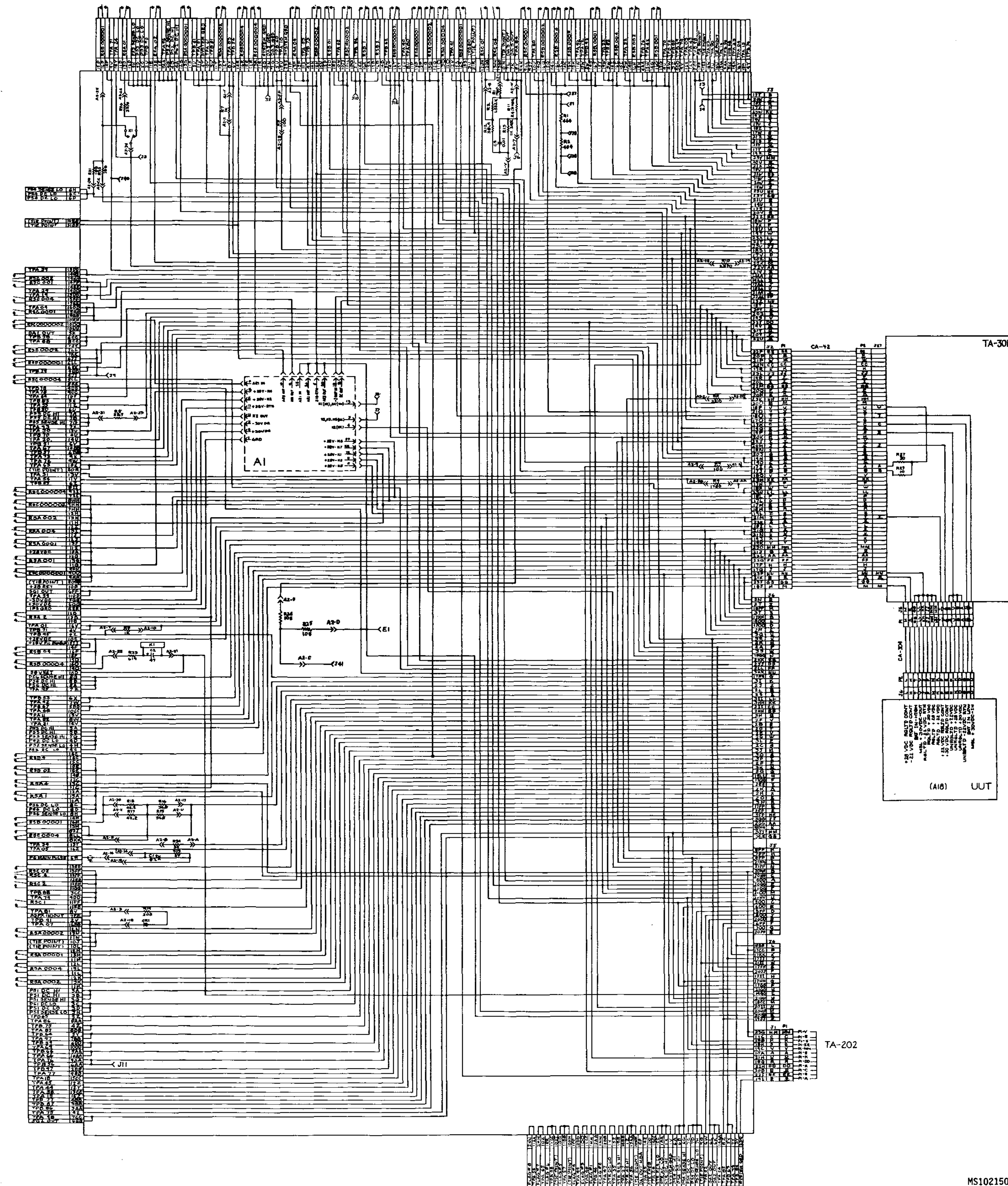

Figure 8-9. UUT 4550, Power Module Assembly (Go-Chain Change 3) Interconnection Diagram.

MS102150A

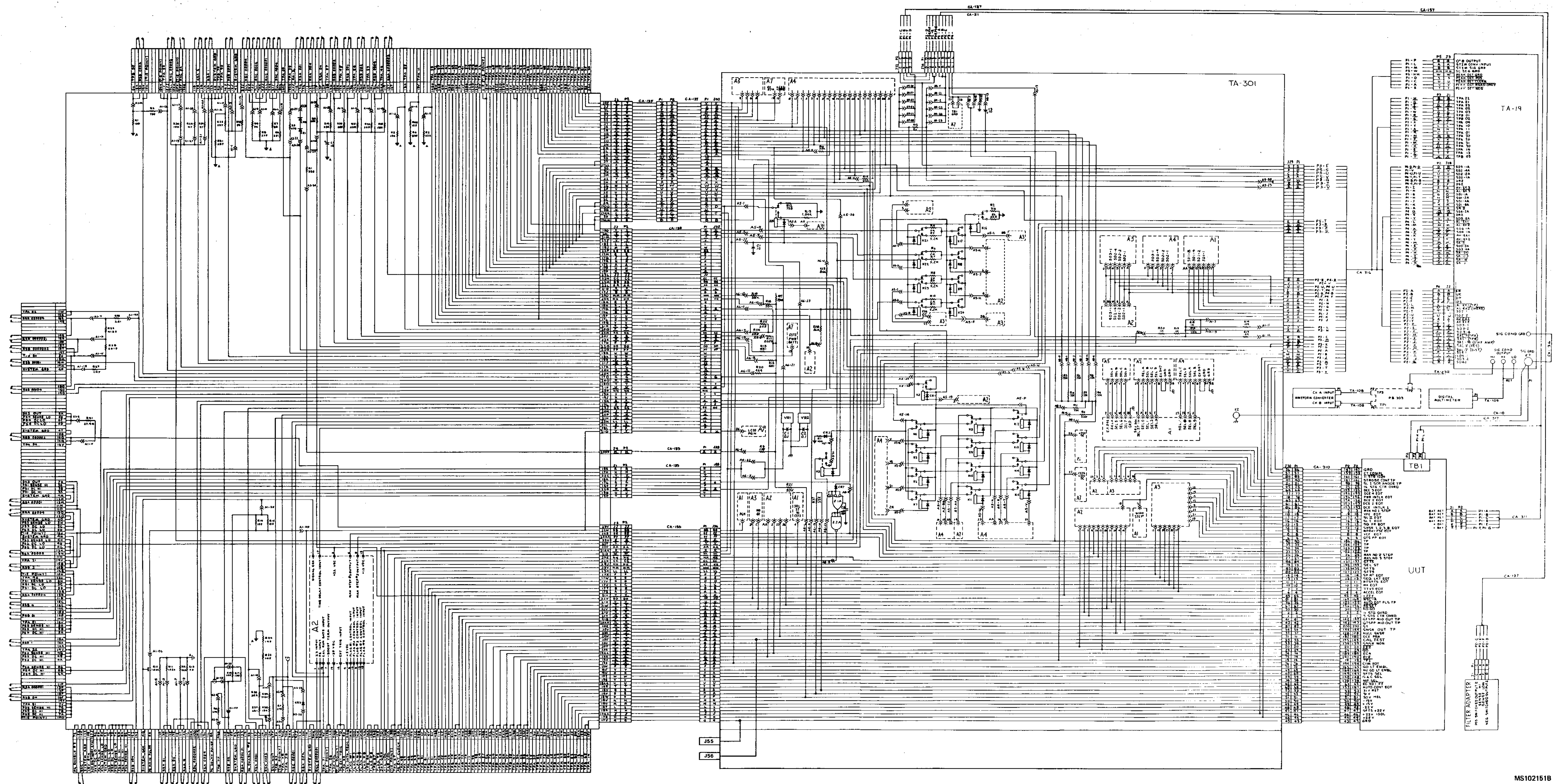

Figure 8-10. UUT 4600, Guided Missile System Test Set, (Survey Hook-Up 1) Interconnection Diagram.

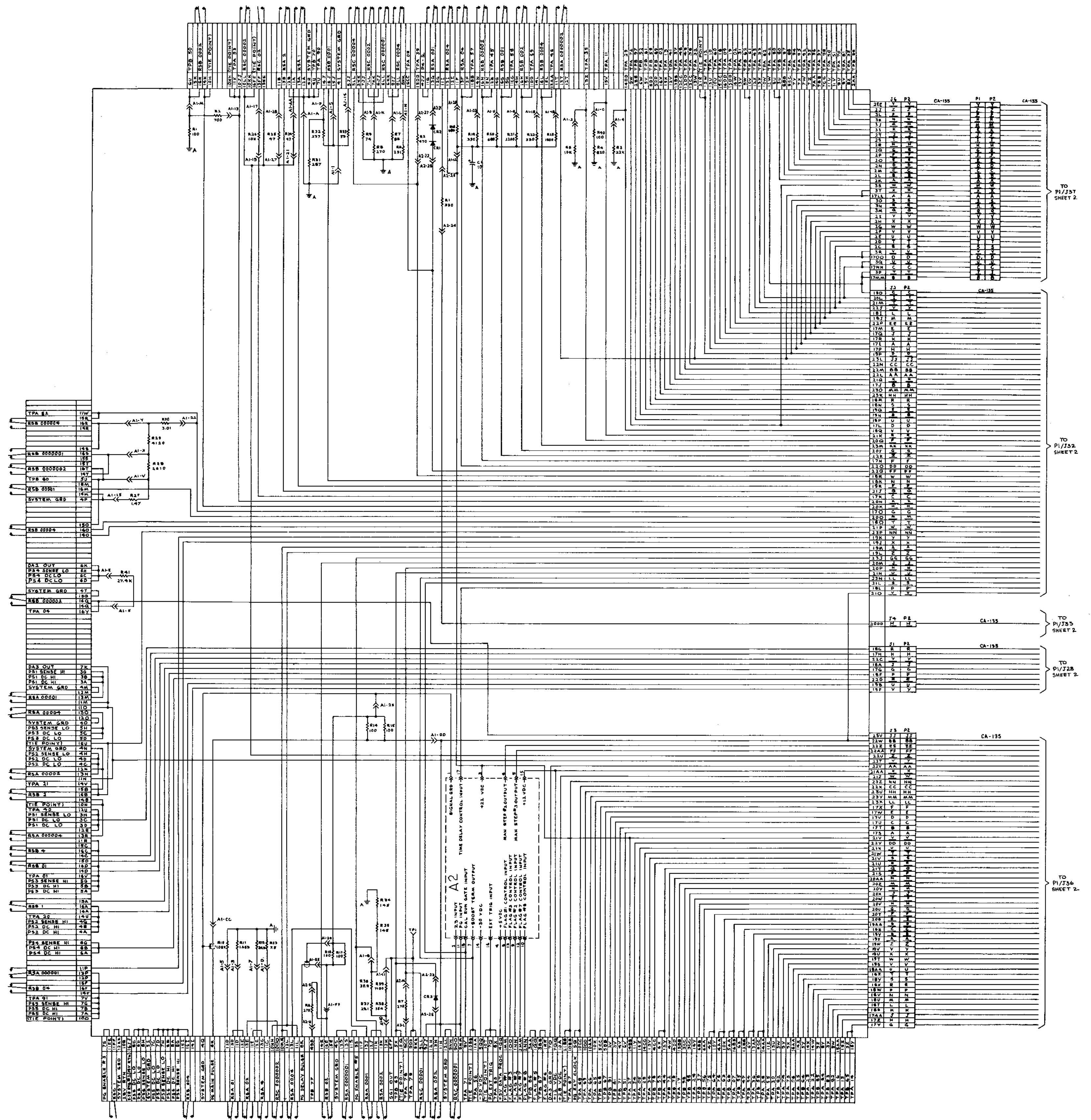

Figure 8-11. UUT 4600, Guided Missile System Test Set, (Survey Hook-Up 2, Go-Chain Cable Change 1) Interconnection Diagram (Sheet 1 of 2).

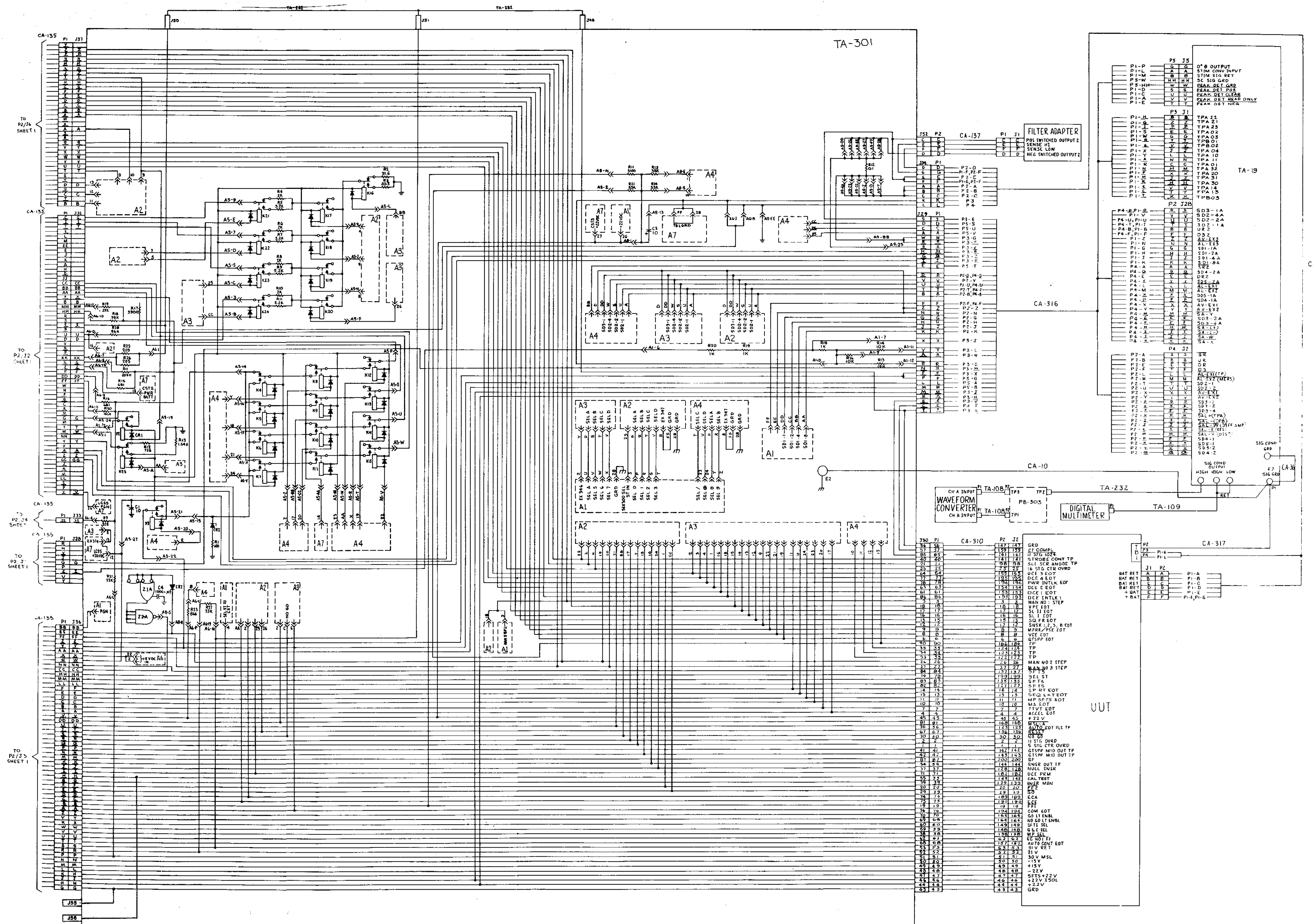
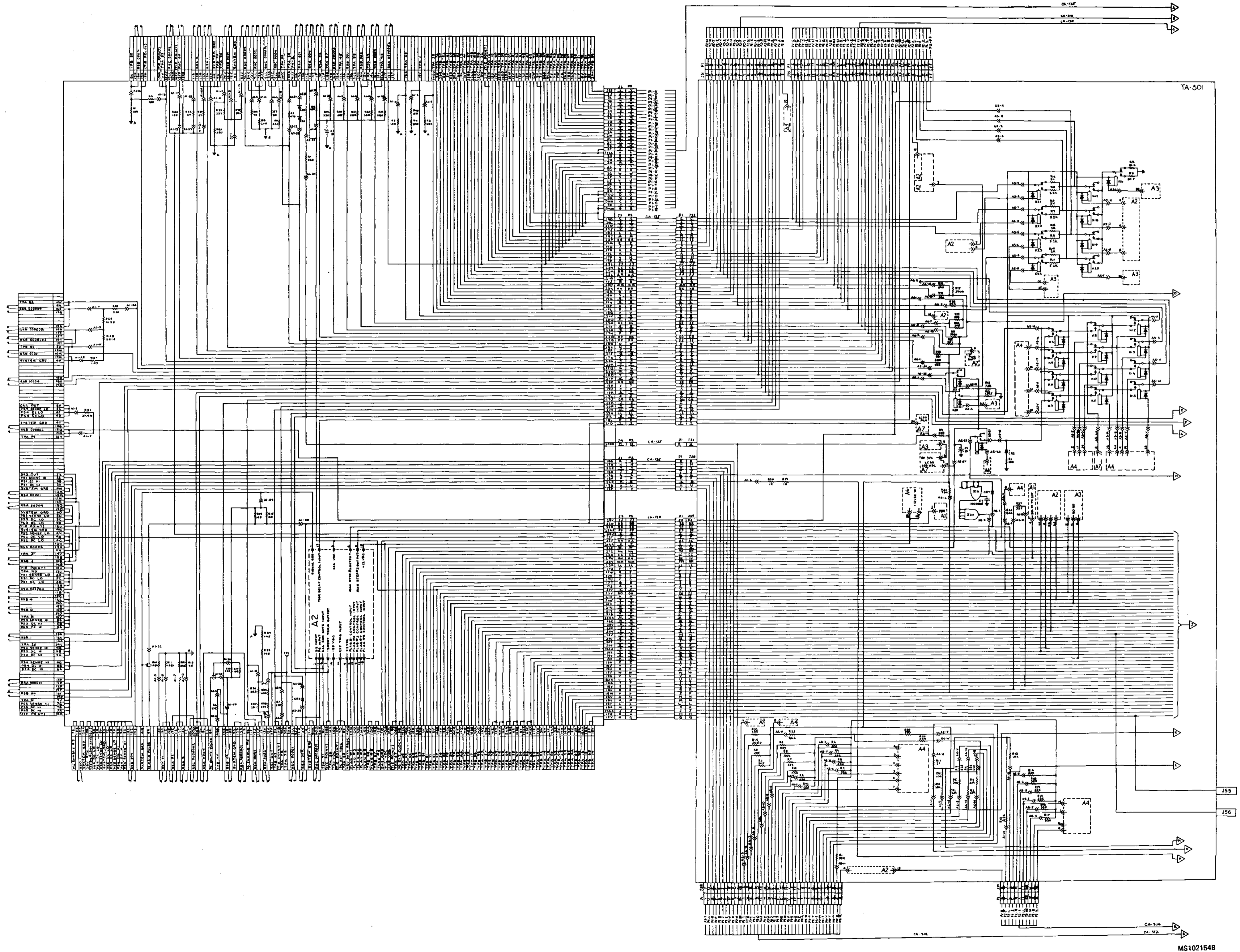

Figure 8-11. UUT 4600, Guided Missile System Test Set, (Survey Hook-Up 2, Go-Chain Cable Change 1) Interconnection Diagram (Sheet 2 of 2).



TA-501

MS102154B

Figure 8-12. UUT 4600, Guided Missile System Test Set, (Go-Chain Cable Change 2) Interconnection Diagram (Sheet 1 of 2).

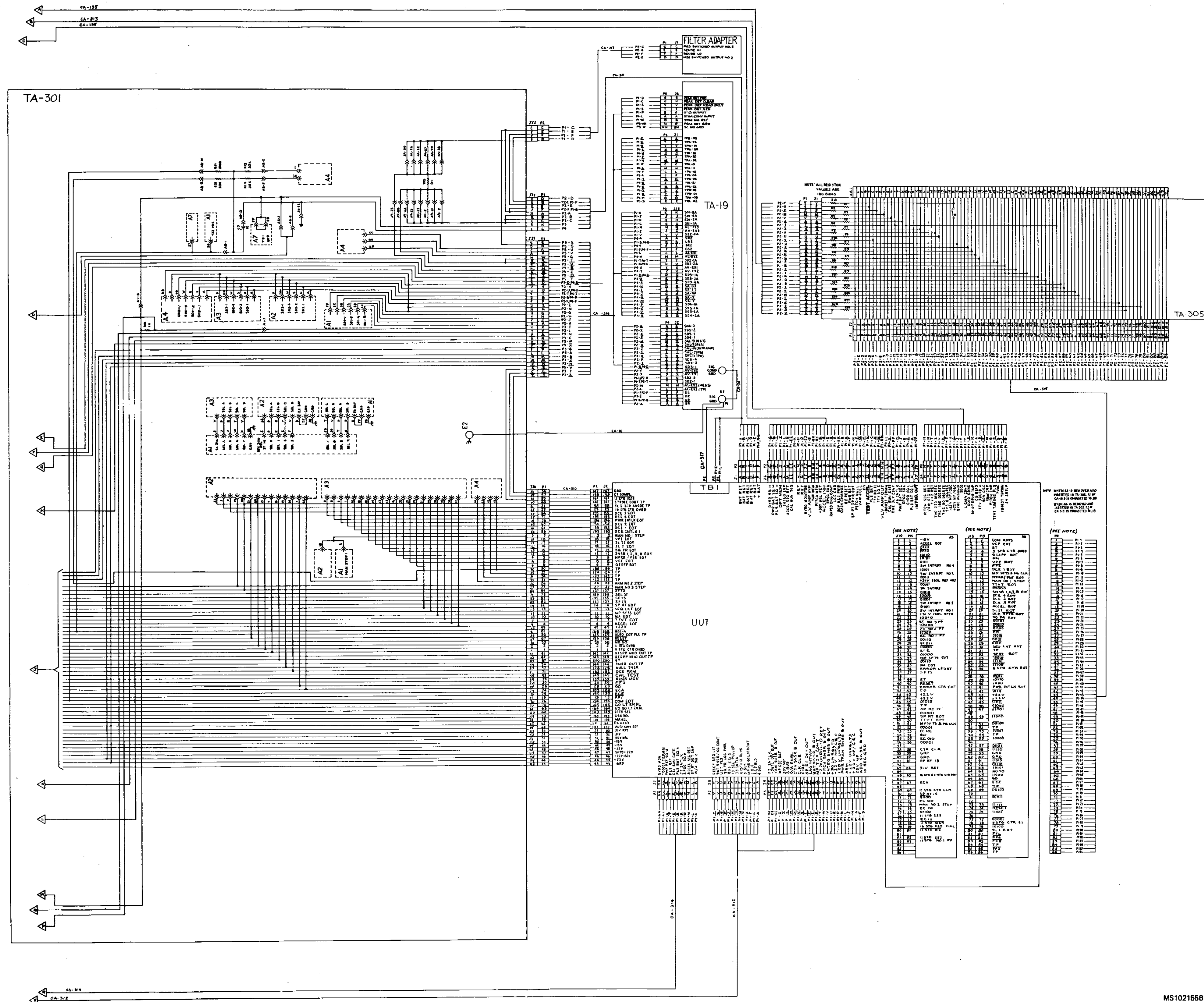

Figure 8-12. UUT 4600, Guided Missile System Test Set, (Go-Chain Cable Change 2) Interconnection Diagram (Sheet 2 of 2).

MS102155B

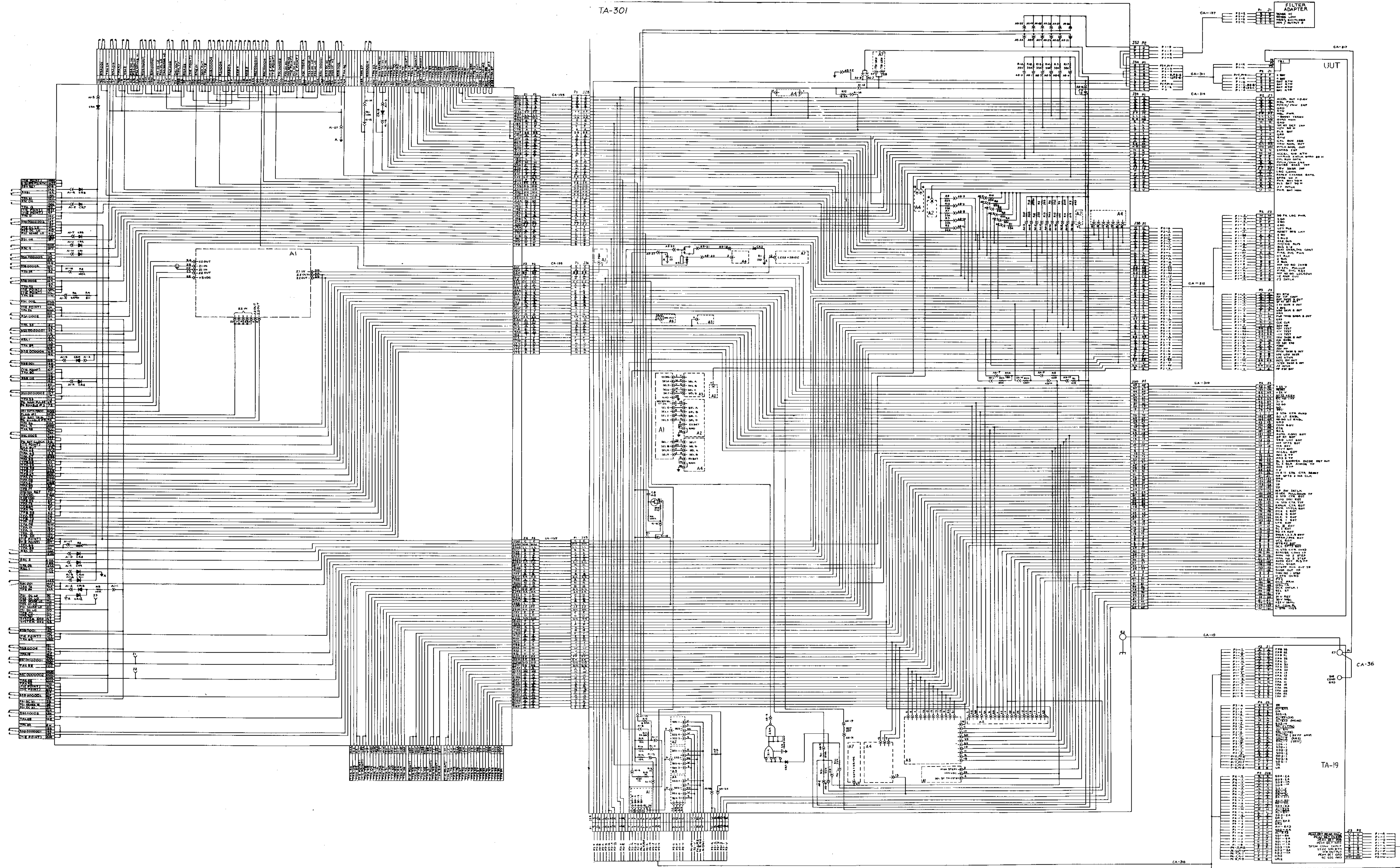

Figure 8-13. UUT 4600, Guidance Missile System Test Set (Go-Chain Cable Change 3) Interconnection Diagram.

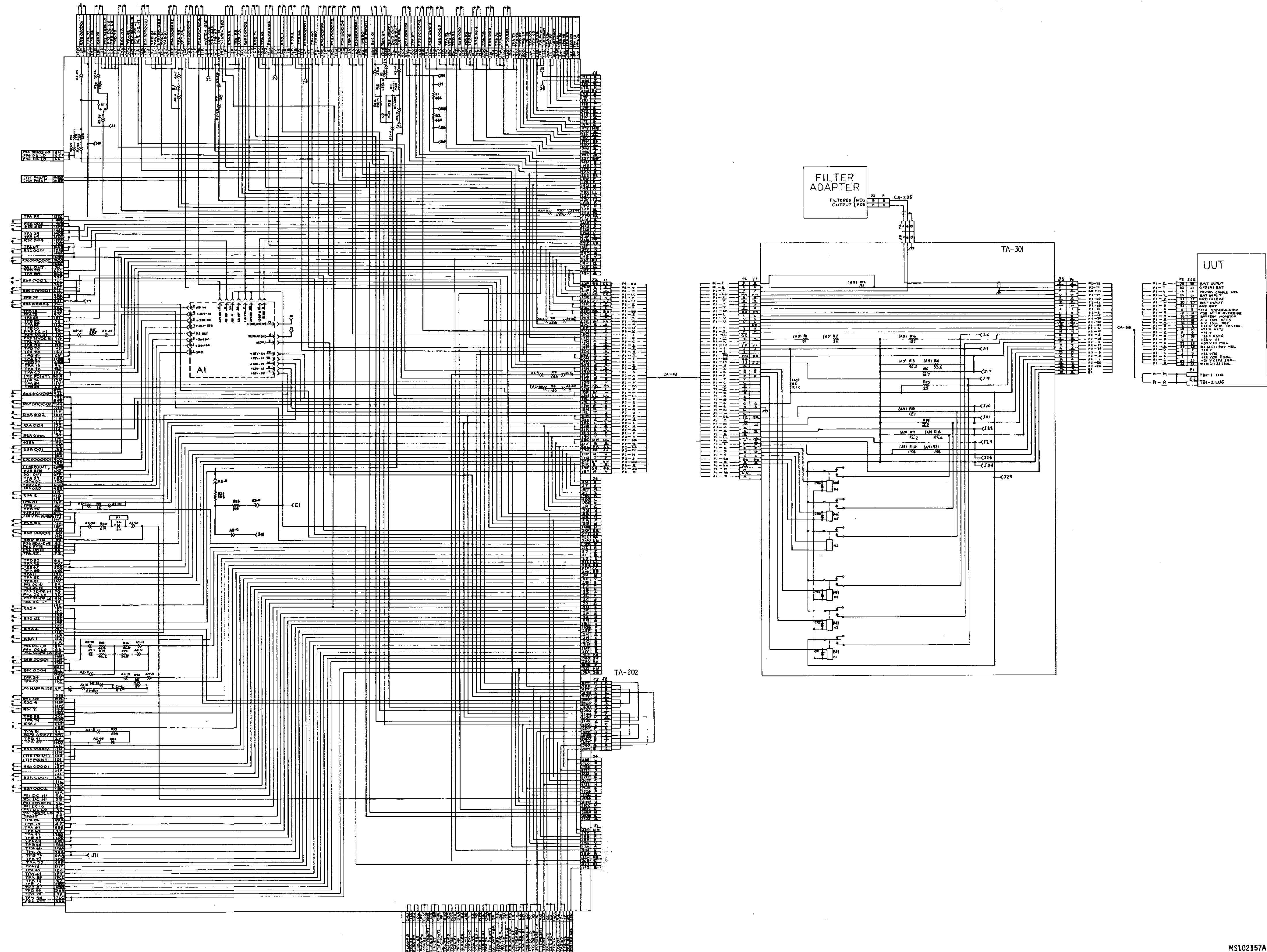

Figure 8-14. UUT 4620, Power Supply Assembly Interconnection Diagram.



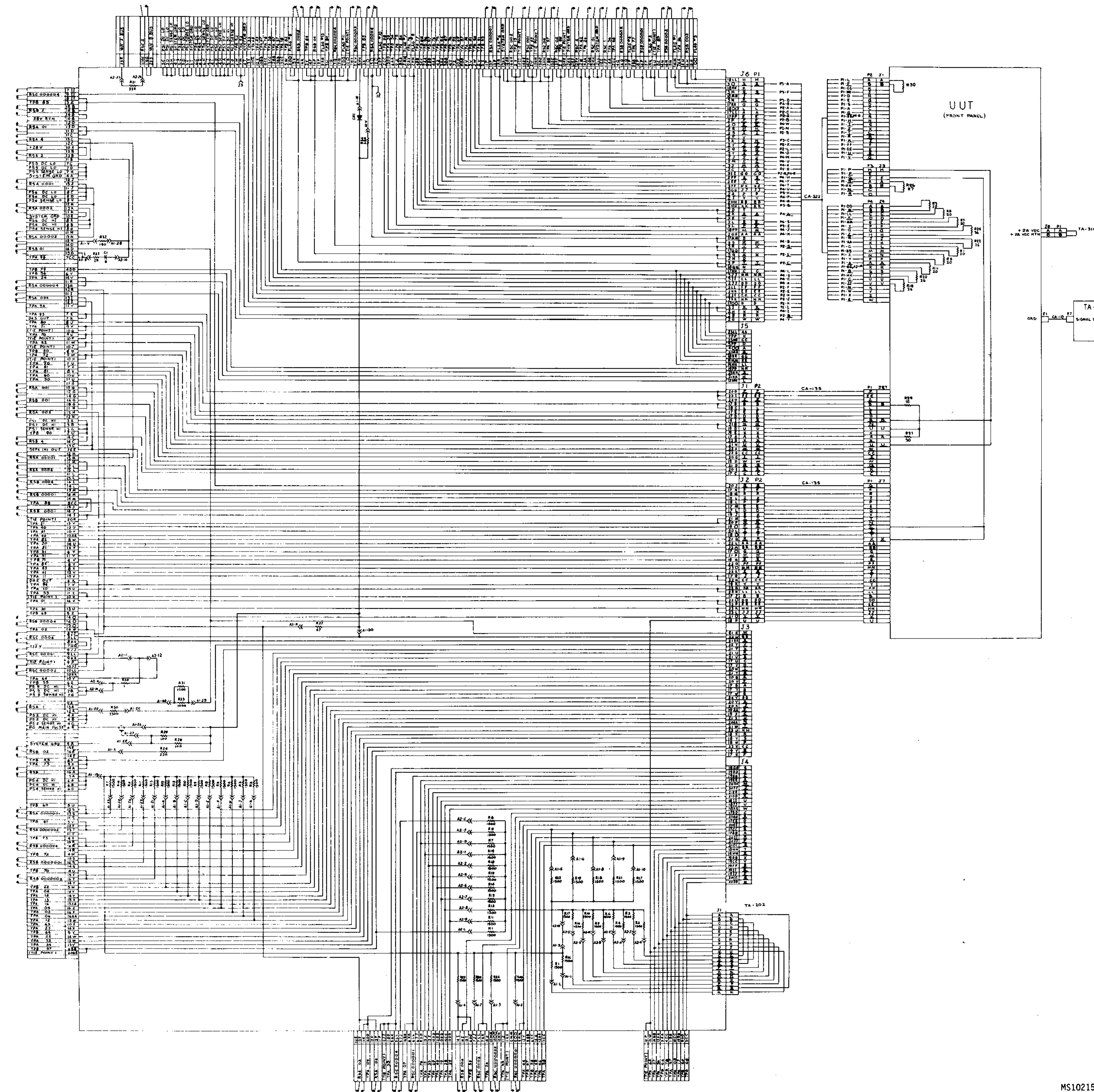

Figure 9-1. UUT 9670, Load Box (Front Panel) Interconnection Diagram.

MS102158A

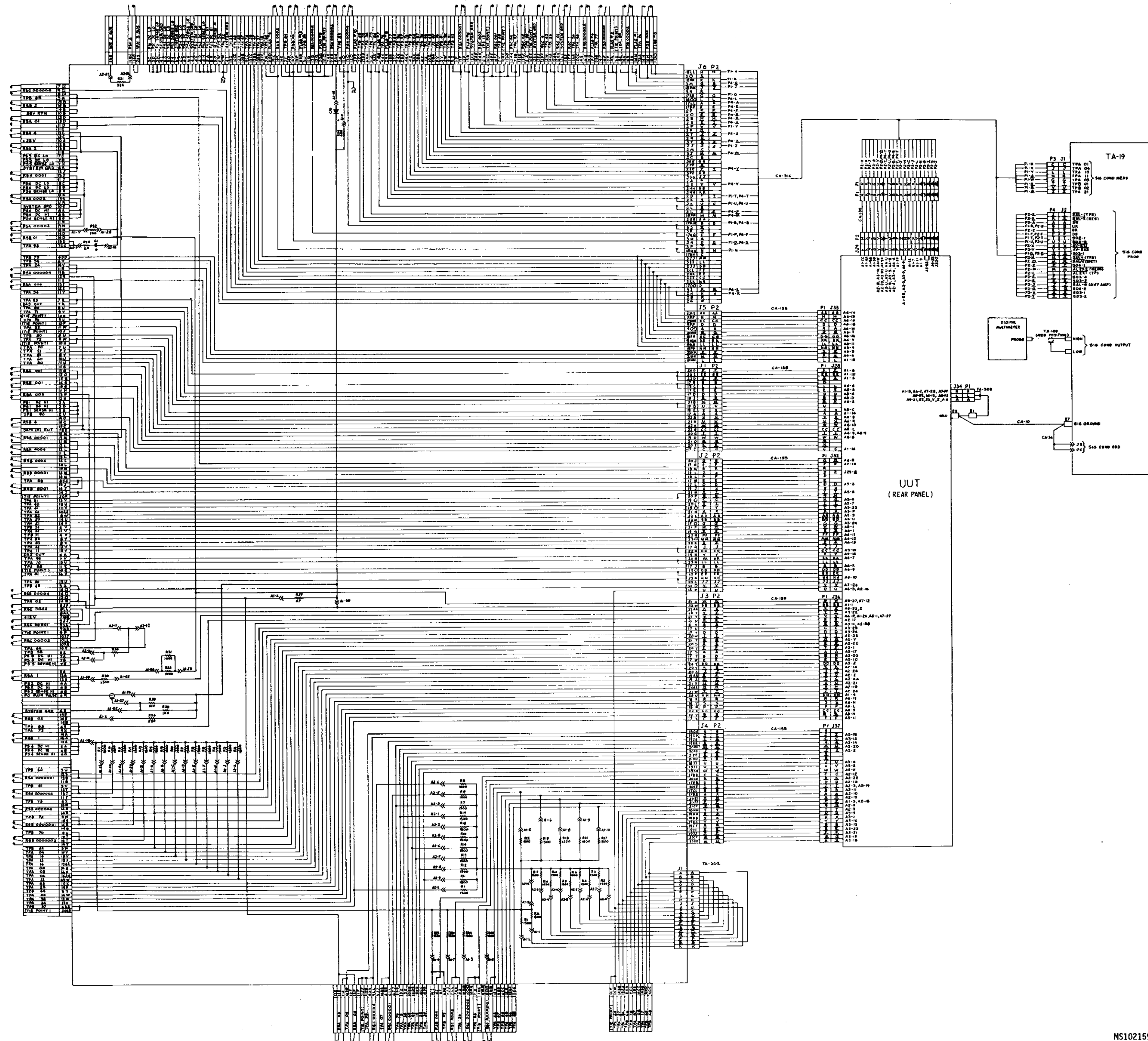

Figure 9-2. UUT 9670, Load Box (Rear Panel) Interconnection diagram.

MS102159A

PATCHBOARD 402

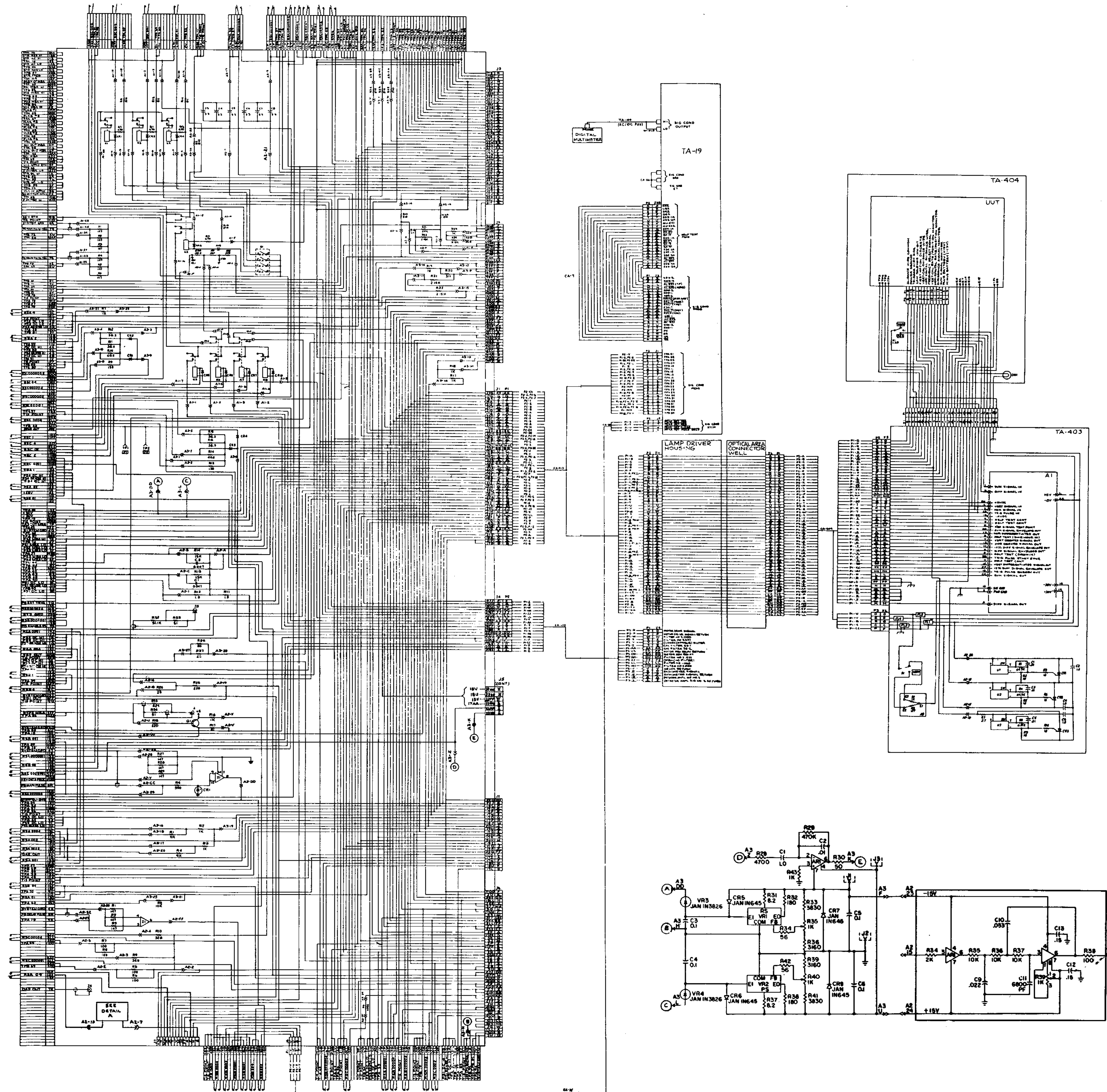

Figure 10-1. UUT 5100, Tracker Interconnection Diagram.

PATCHBOARD 402

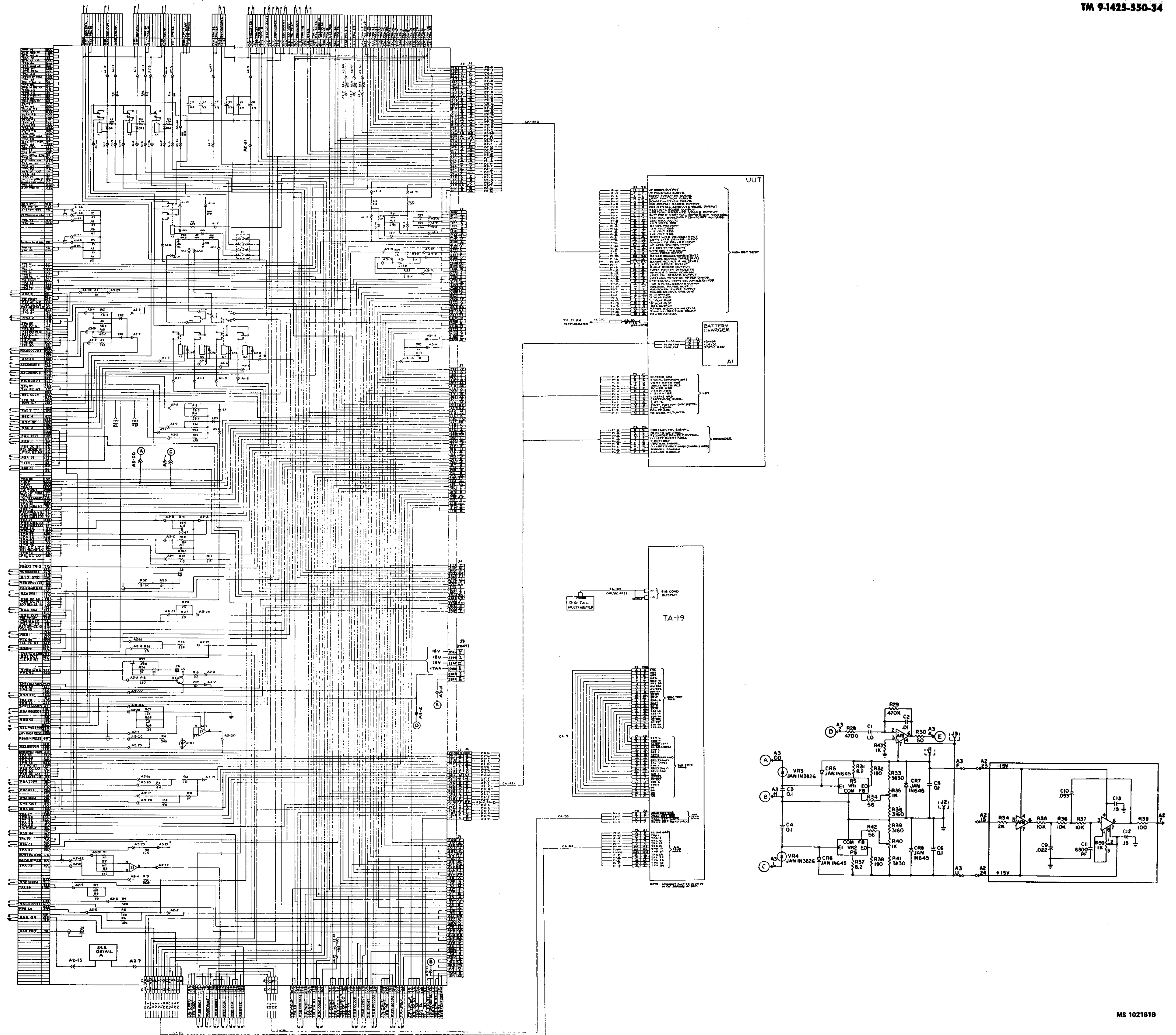

Figure 10-2. UUT 5200, Monitoring Set Interconnection Diagram.

PATCHBOARD 402

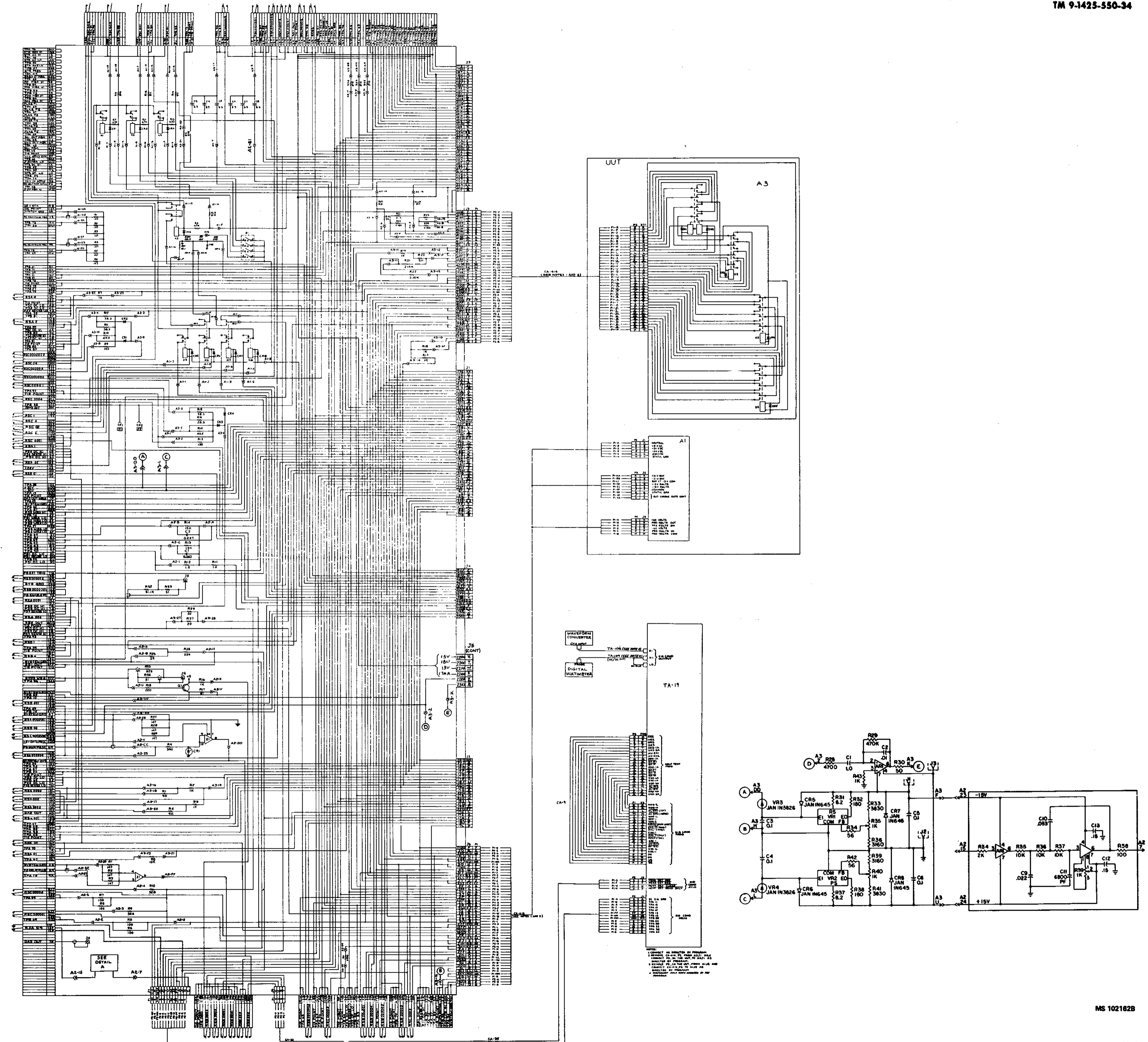

Figure 10-3. UUT 5200, Monitoring Set (Survey Hook-Up) Interconnection Diagram.

PATCHBOARD 402

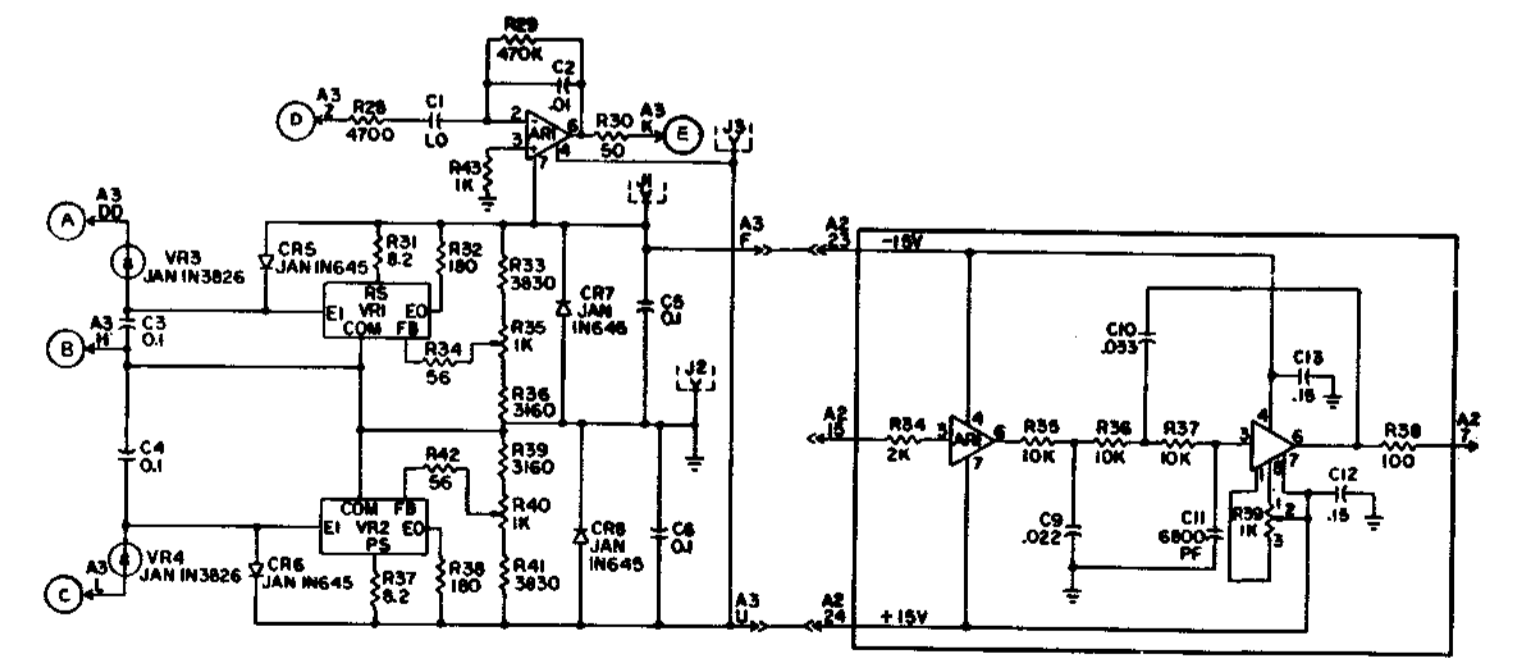
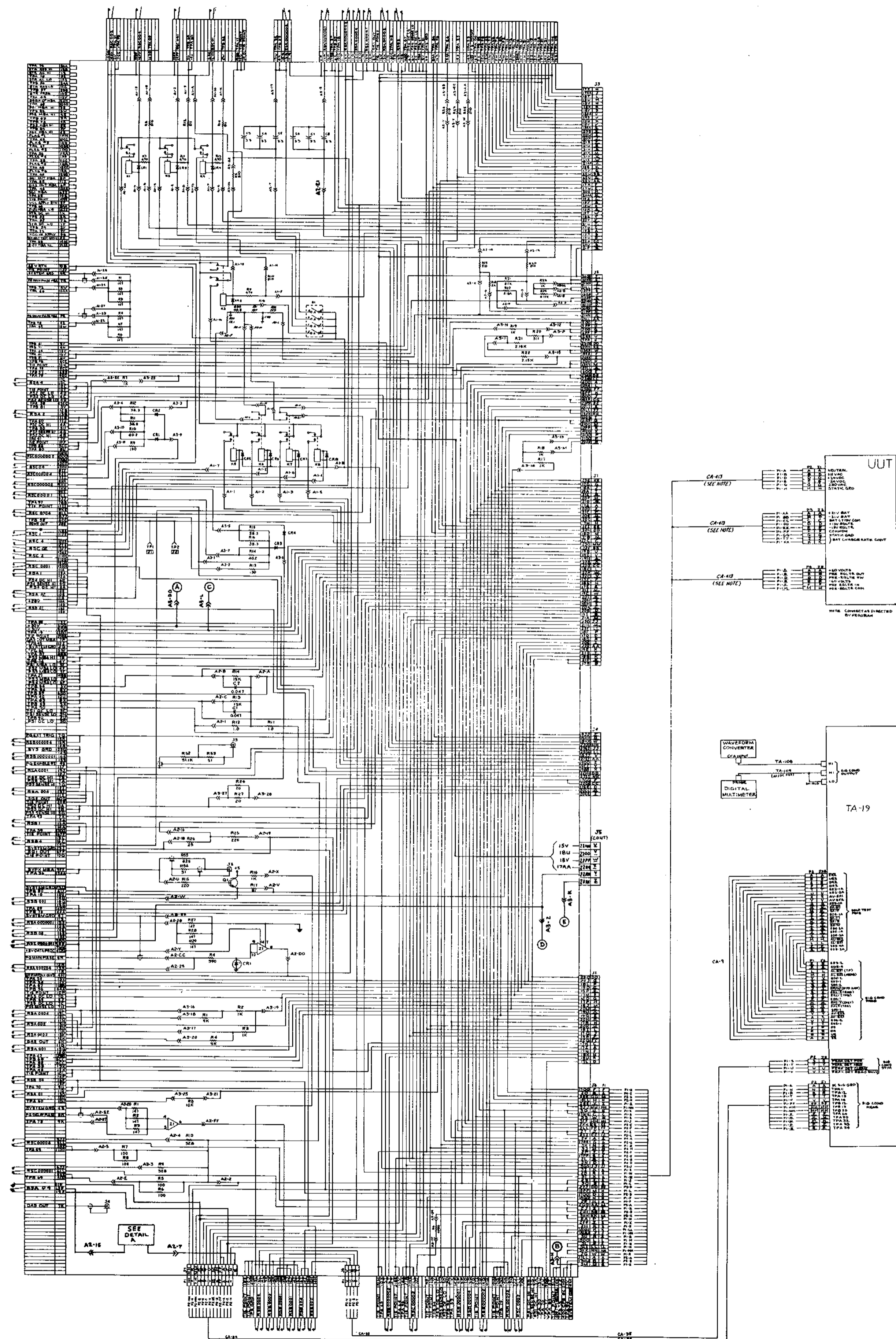

Figure 10-4. UUT 5220, Battery Charger Interconnection Diagram.

PATCHBOARD 402

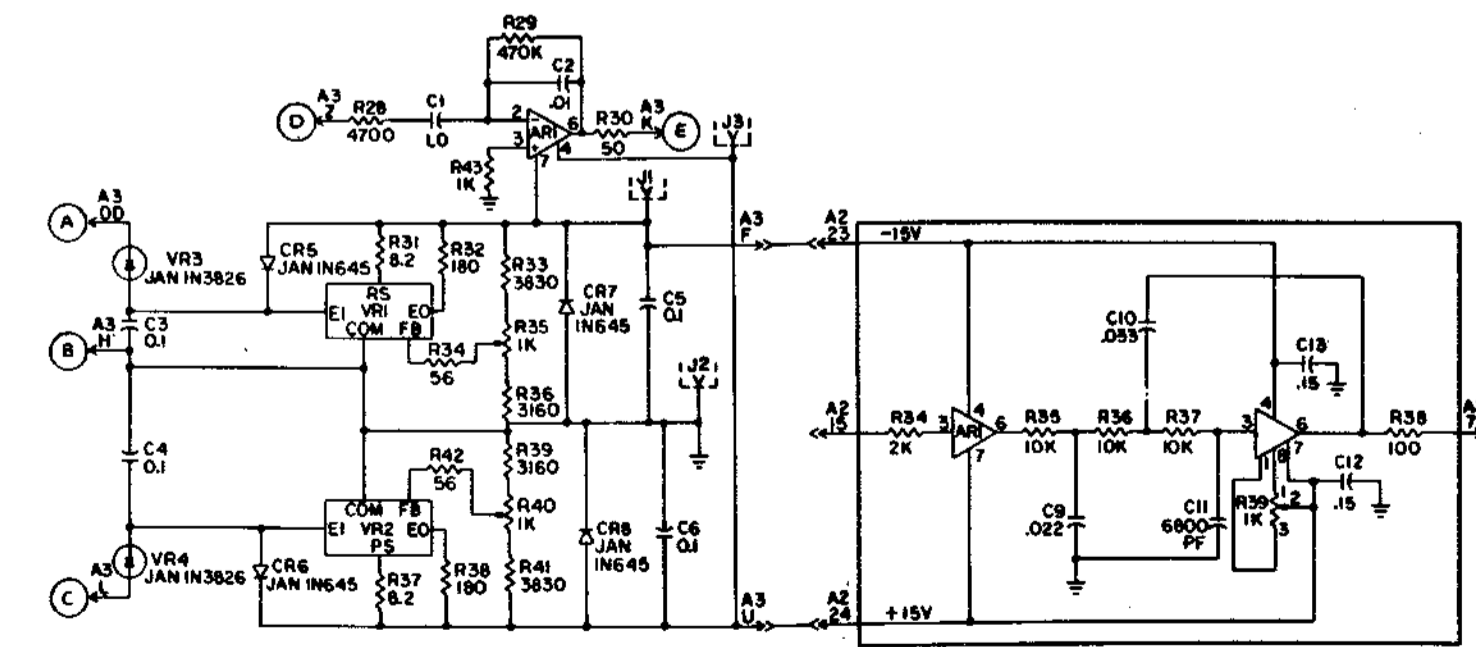
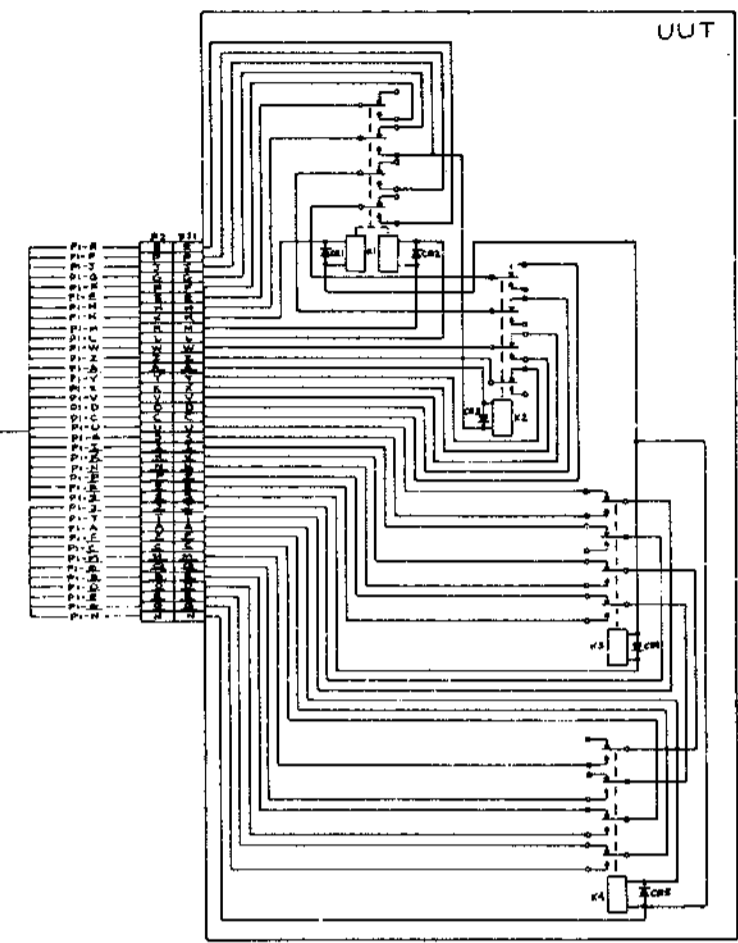
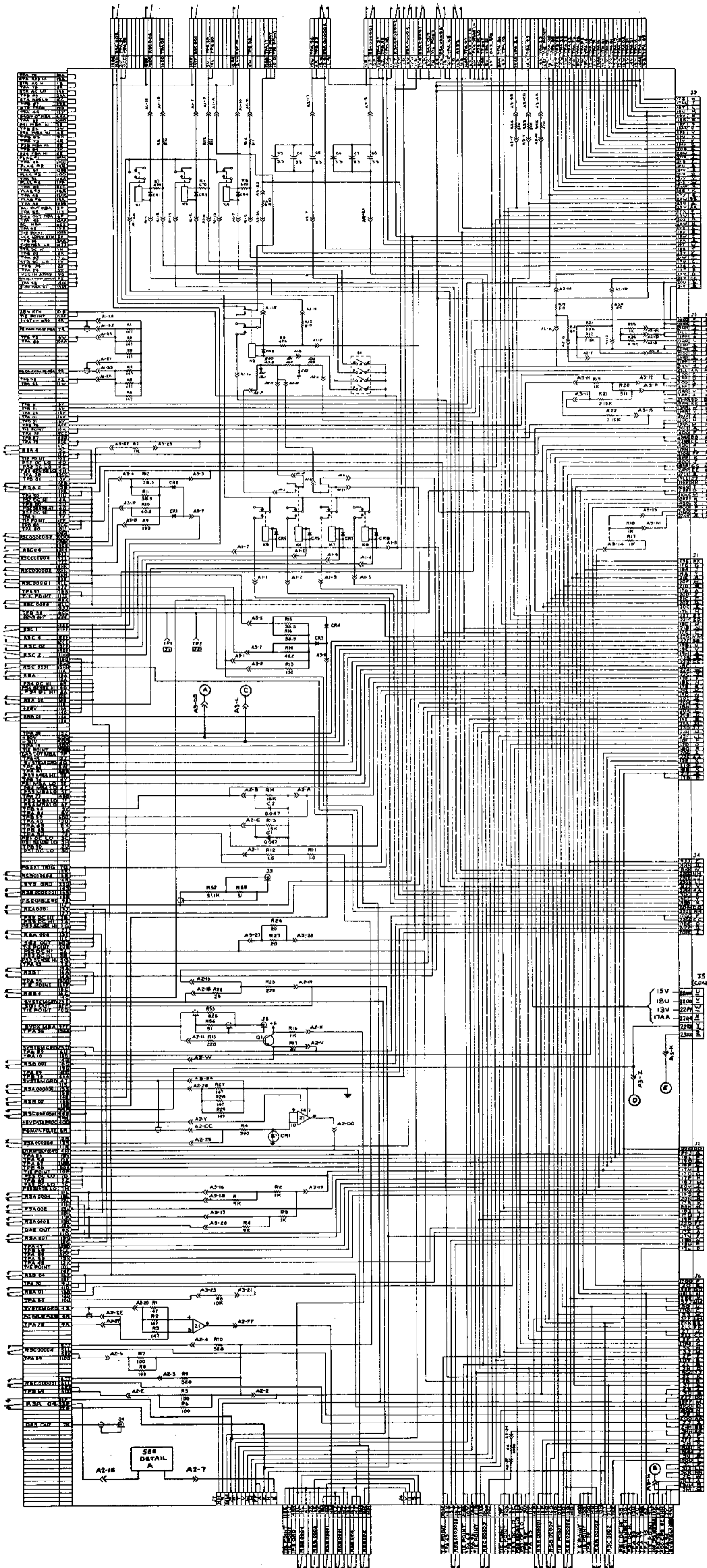

Figure 10-5. UUT 5240, Relay Panel Assembly Interconnection Diagram.

C4

PATCHBOARD 401

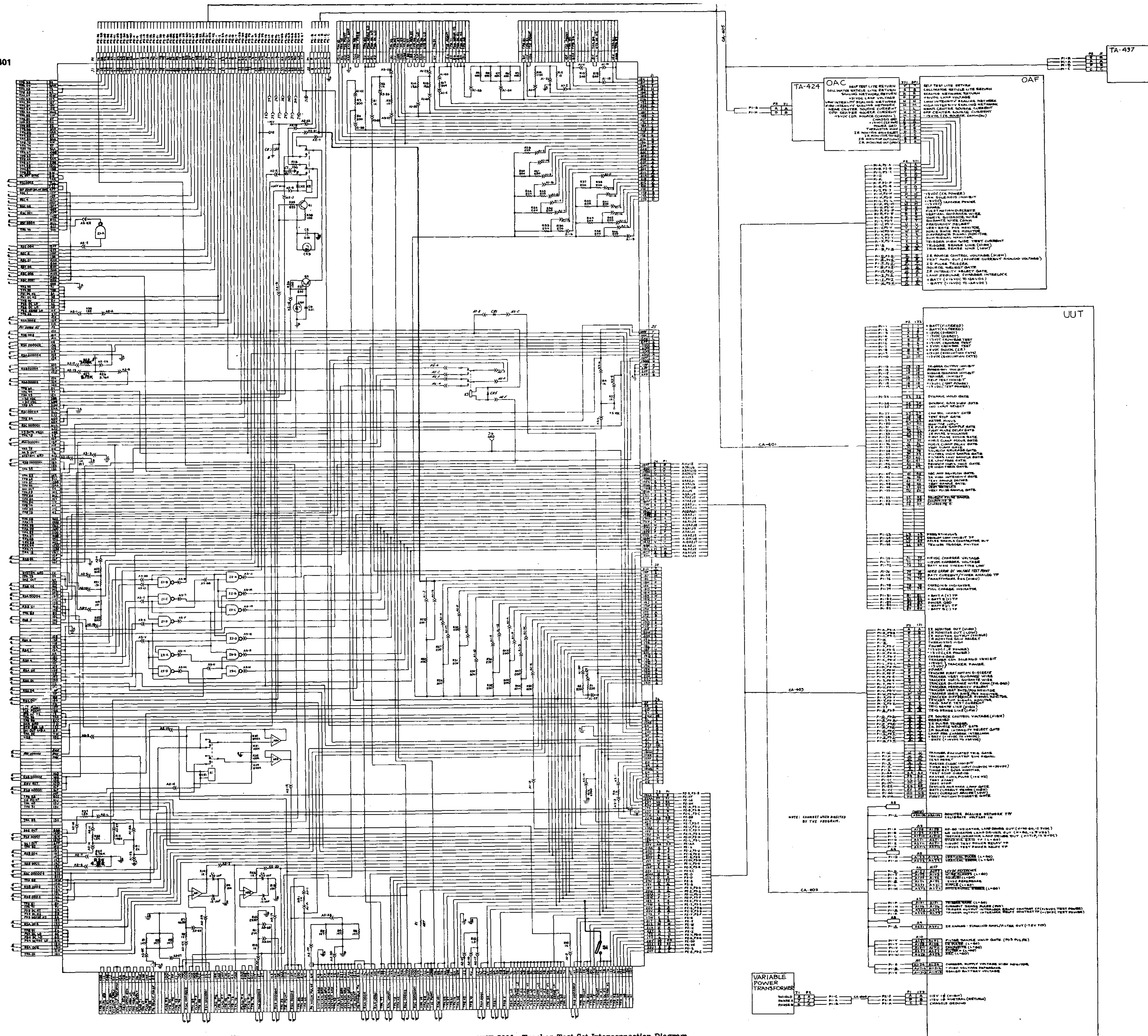

Figure 10-6. UUT 5300, Tracker Test Set Interconnection Diagram.



PATCHBOARD 401

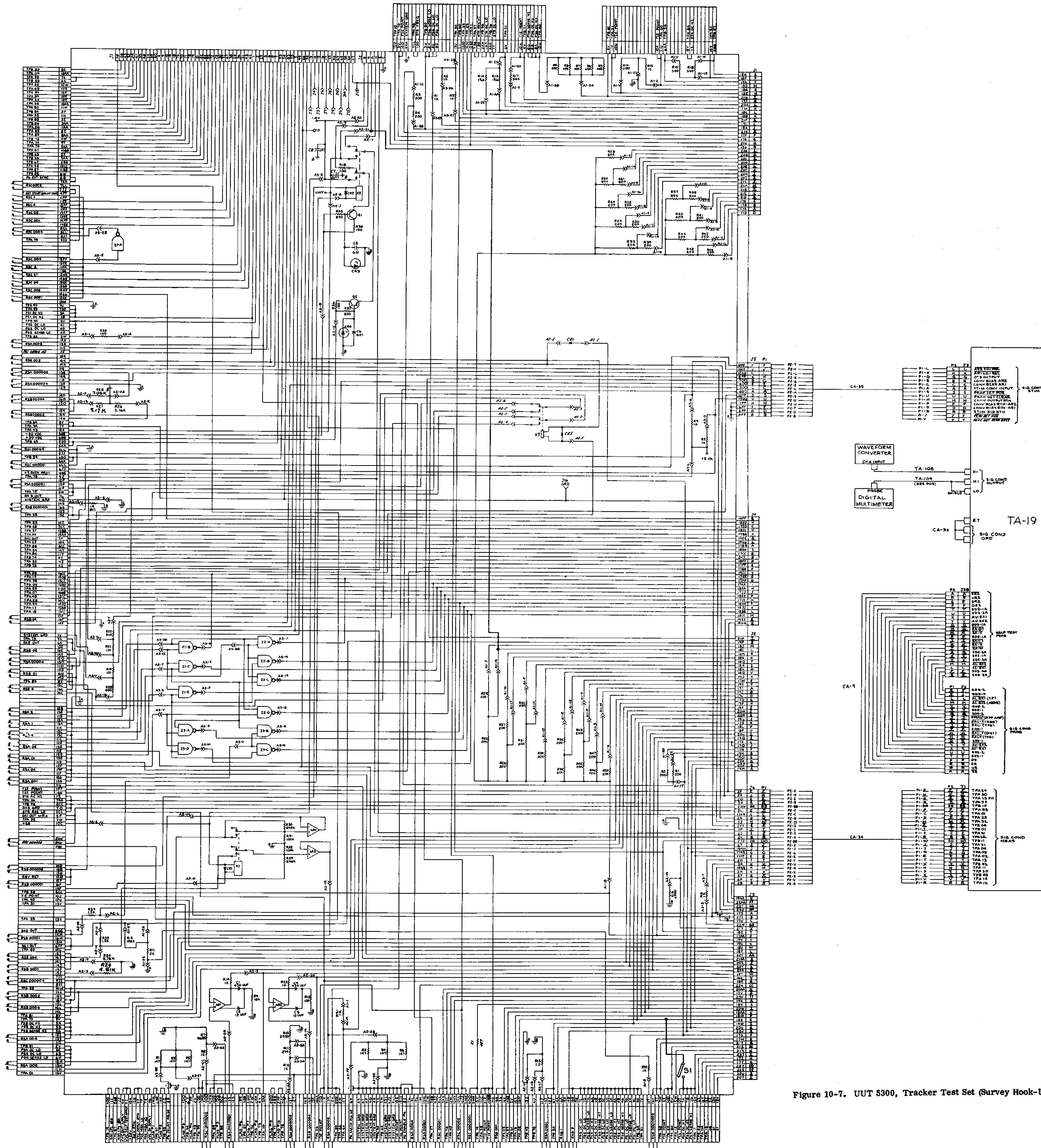

Figure 10-7. UUT 5300, Tracker Test Set (Survey Hook-Up) Interconnection Diagram.

PATCHBOARD 401

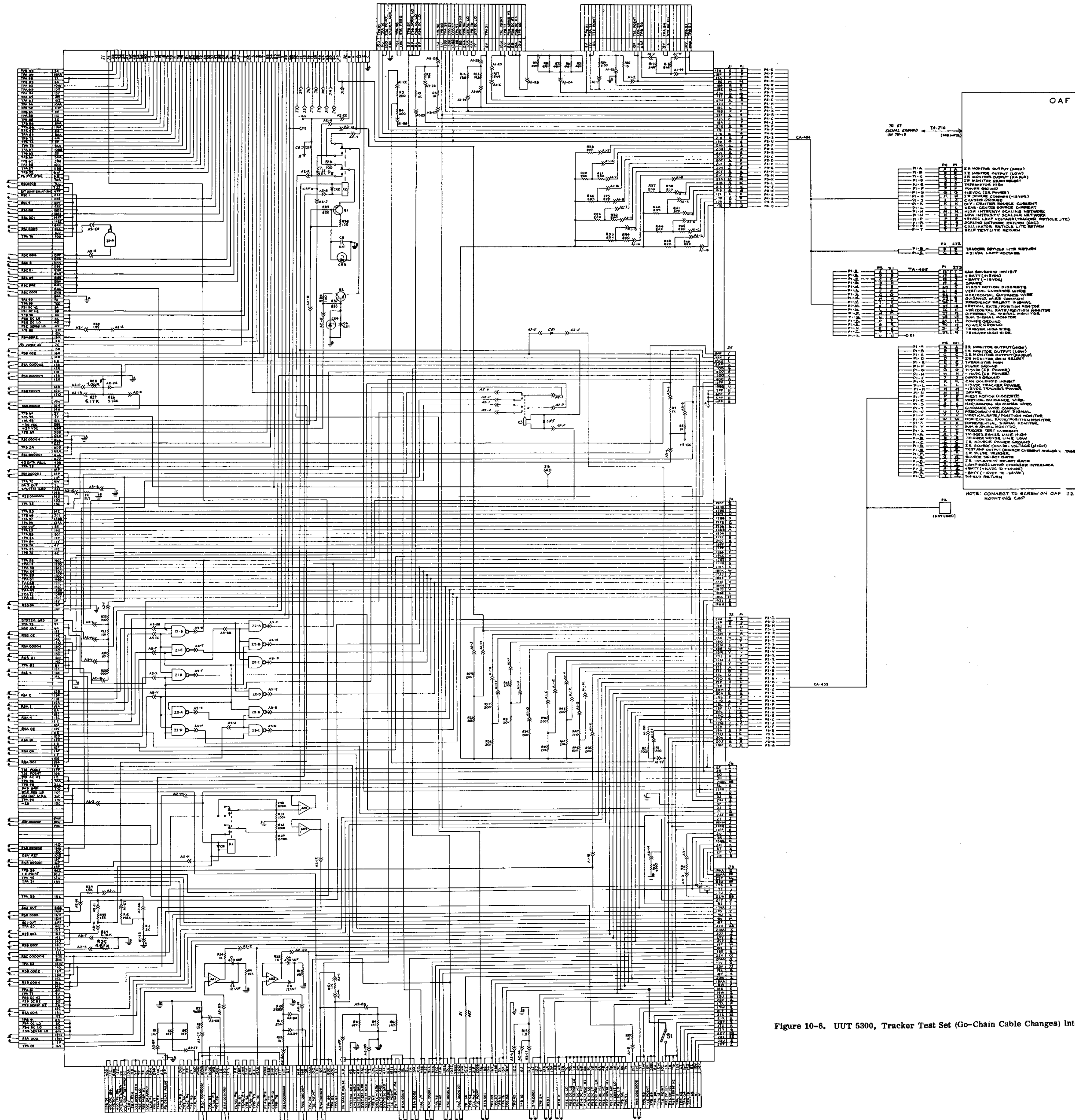

Figure 10-8. UUT 5300, Tracker Test Set (Go-Chain Cable Changes) Interconnection Diagram.

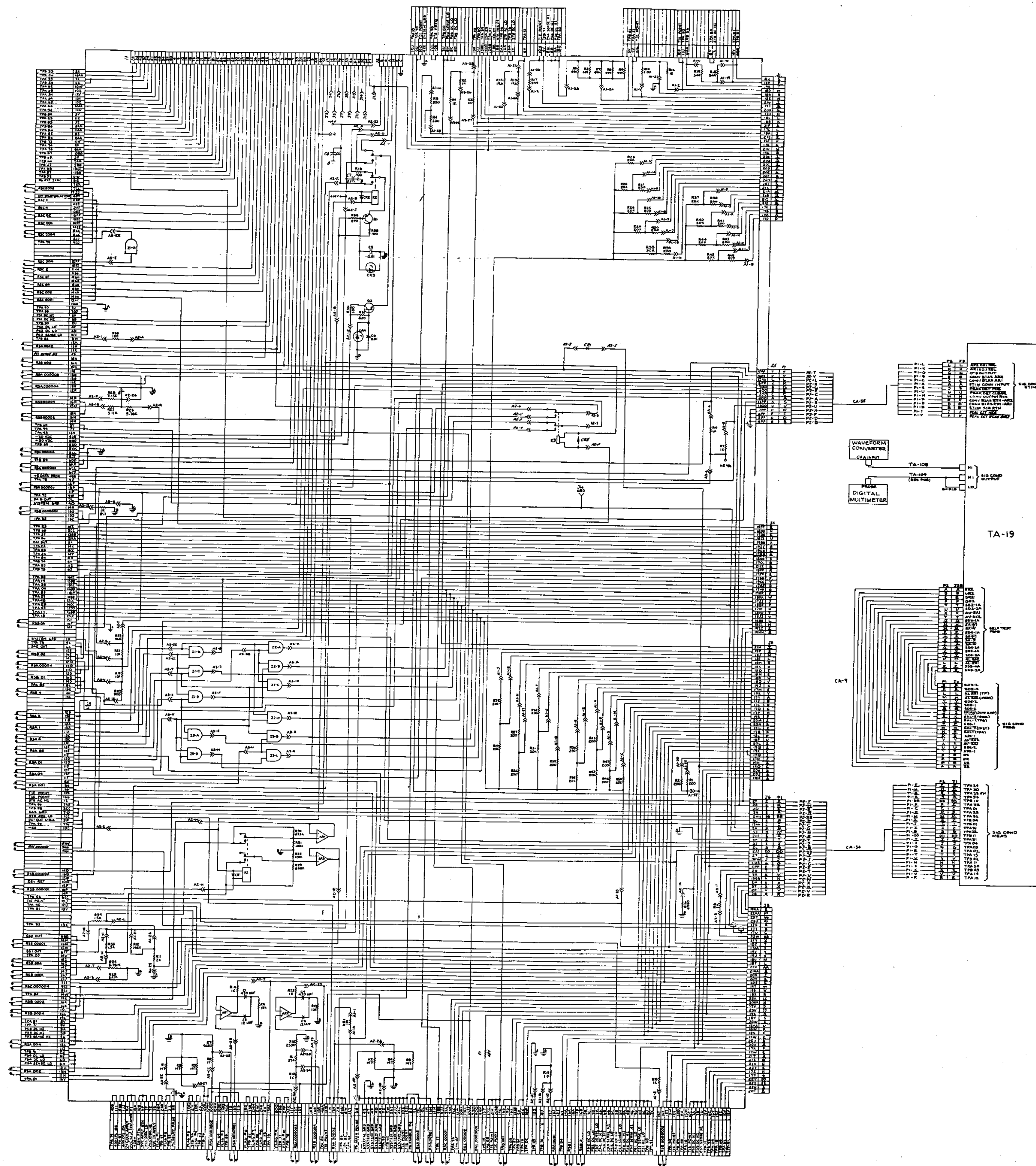

Figure 10-9. UUT 5320, Monitor Unit (Survey Hook-Up) Interconnection Diagram.

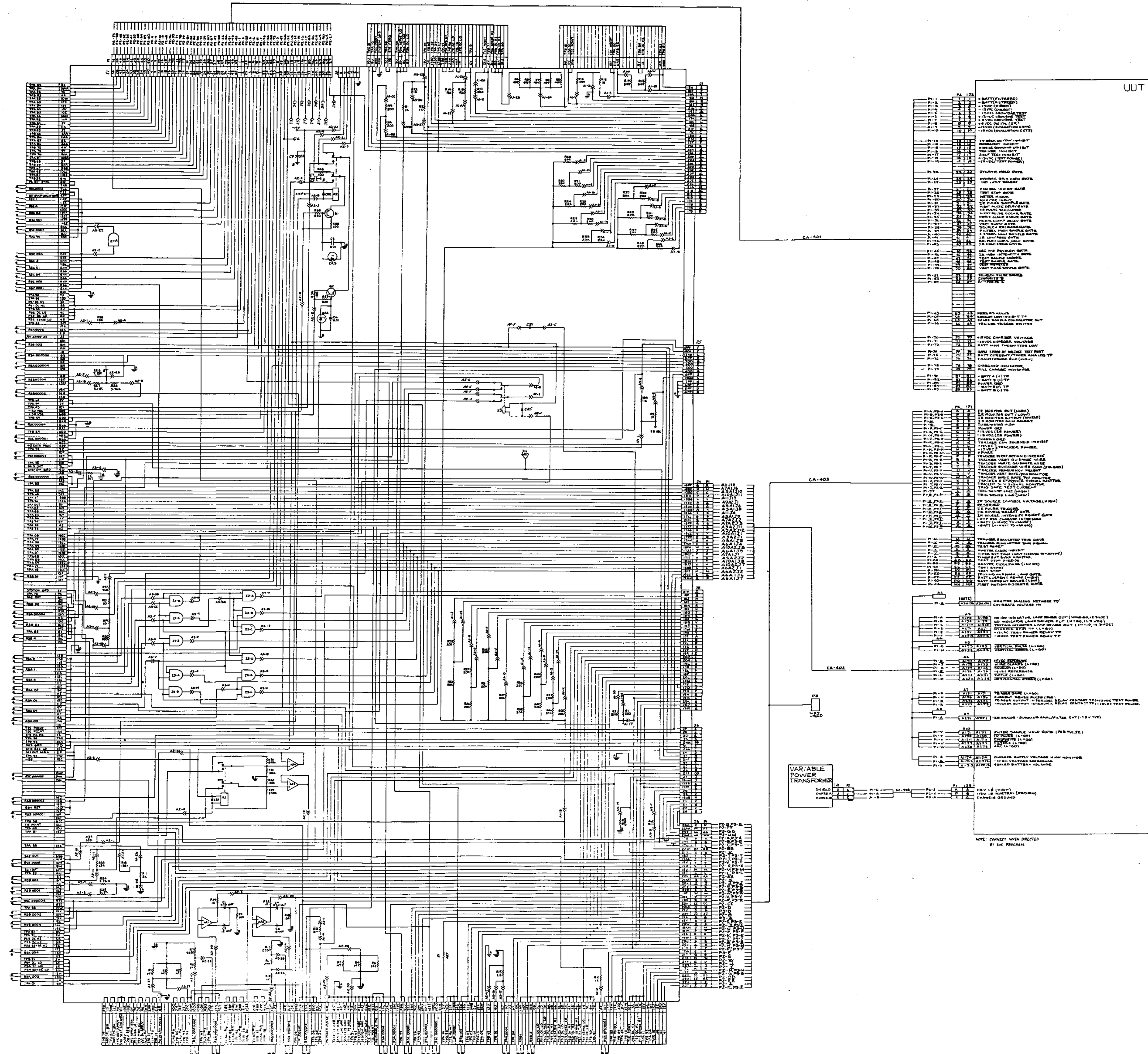

Figure 10-10. UUT 5320, Monitor Unit (Dynamic Hook-Up) Interconnection Diagram.

PATCHBOARD 401

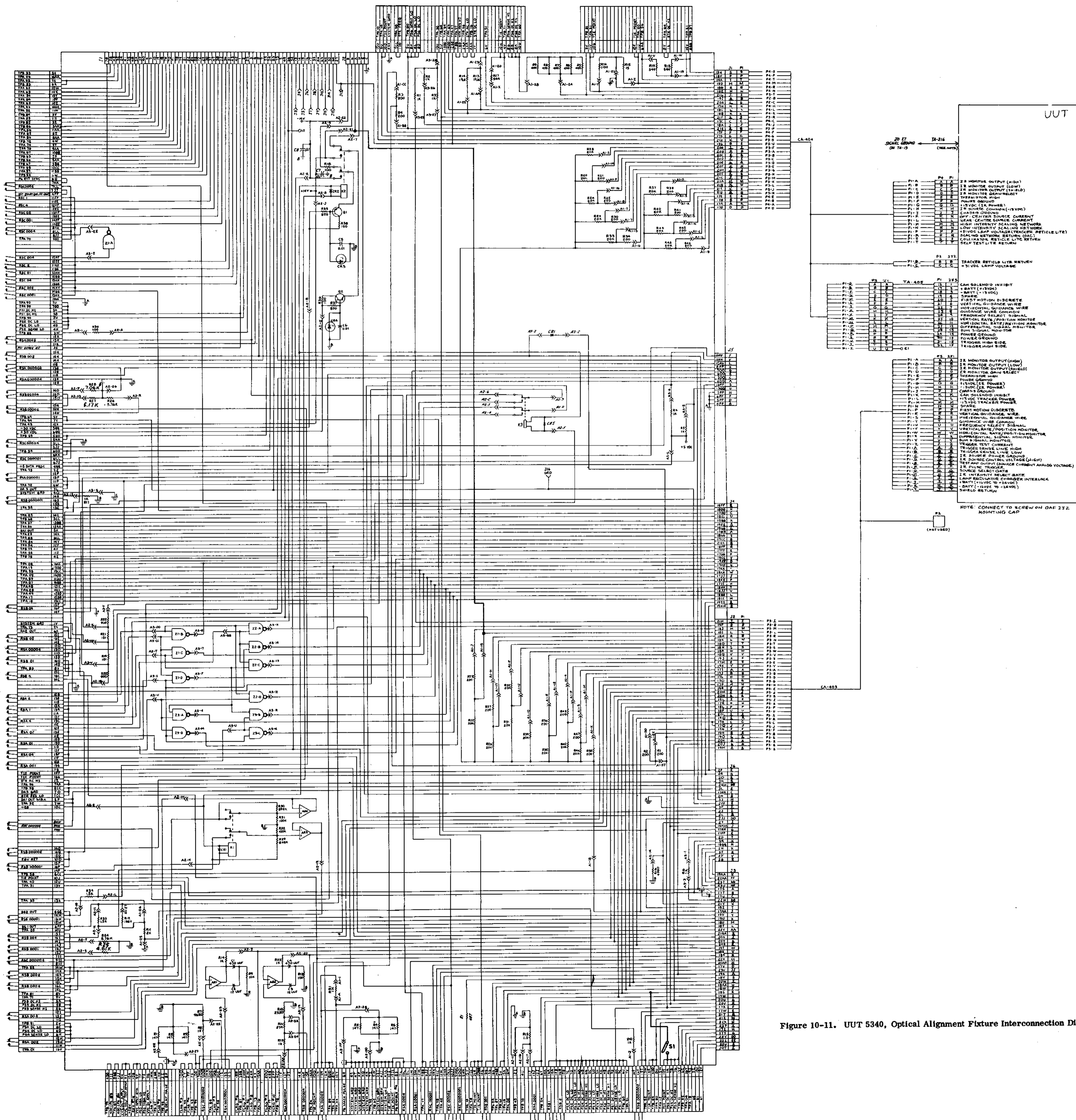

Figure 10-11. UUT 5340, Optical Alignment Fixture Interconnection Diagram.

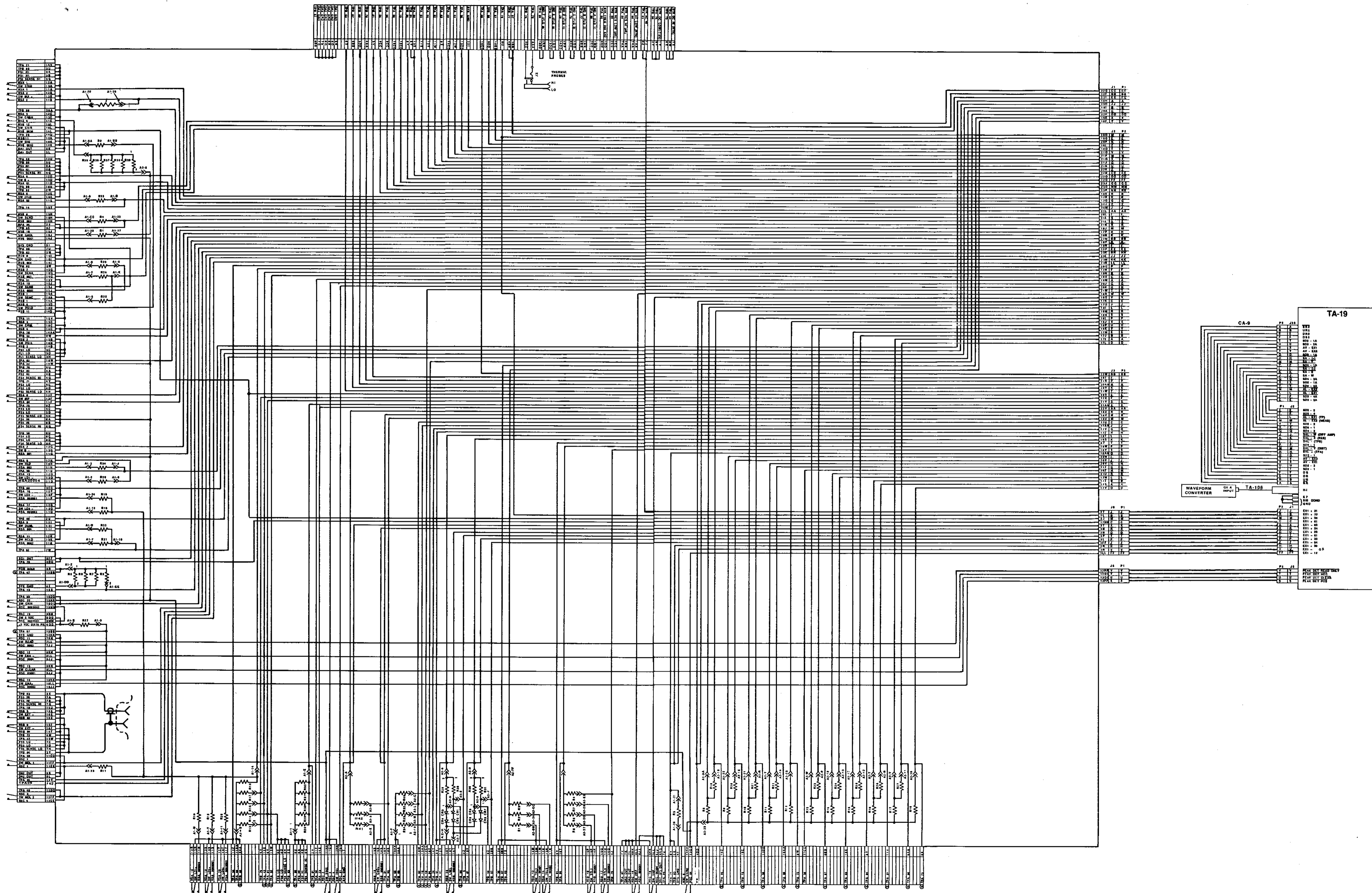

Figure 10-12. UUT 5350, Night/Day Optical Alignment Fixture (Survey Hookup) Interconnection Diagram.

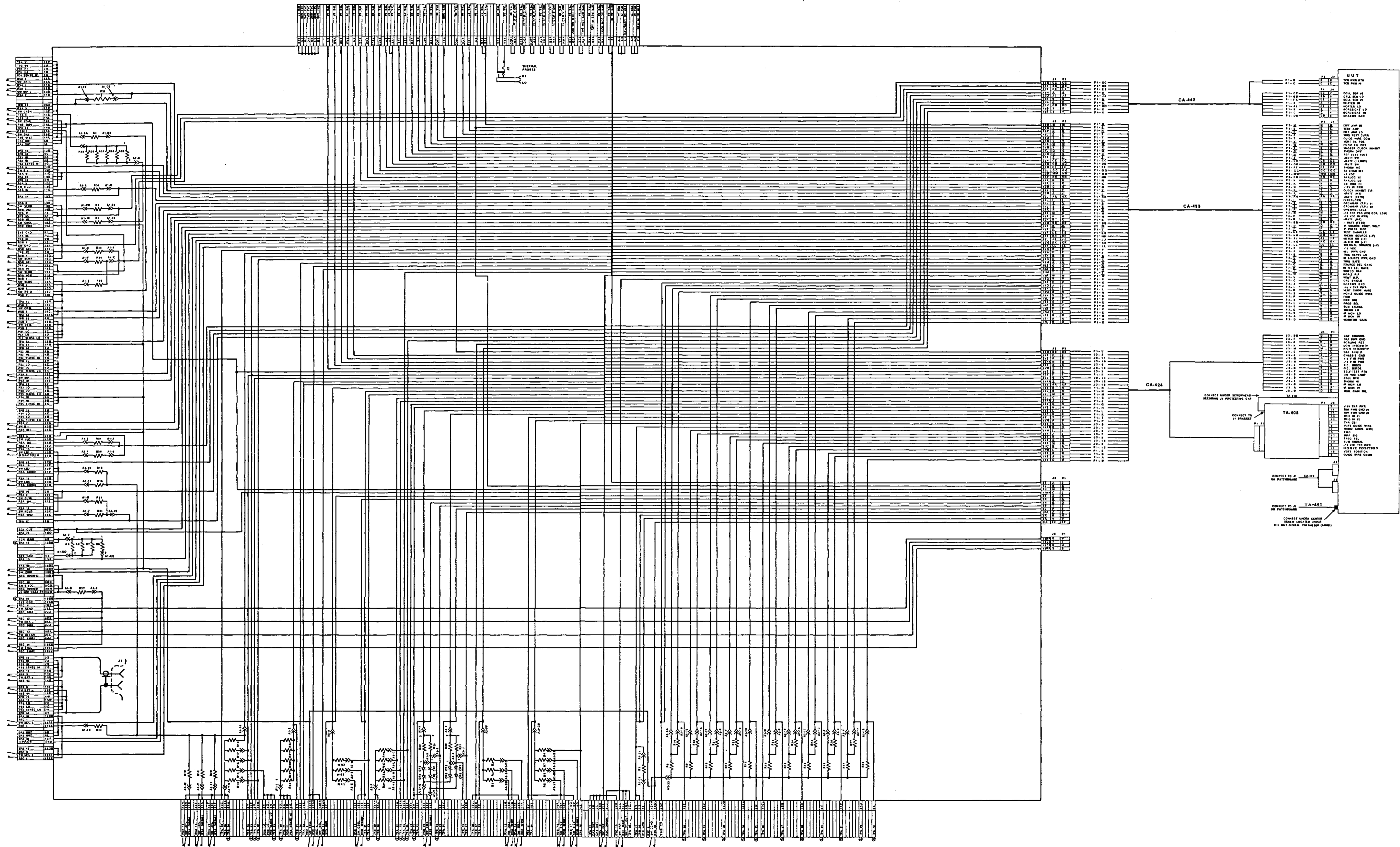

Figure 10-13. UUT 5350, Night/Day Optical Alignment Fixture (Dynamic Hookup) Interconnection Diagram.

By Order of the Secretary of the Army:

CREIGHTON W. ABRAMS  
*General, United States Army*  
*Chief of Staff*

Official:  
VERNE L. BOWERS  
*Major General, United States Army*  
*The Adjutant General*

Distribution:  
To be distributed in accordance with DA Form 12-32 (qty rqr block No. 592) direct and general support maintenance requirements applicable to LCSS.



